



# *ALGEBRA FX 2.0*

## *User's Guide*



GUIDELINES LAID DOWN BY FCC RULES FOR USE OF THE UNIT IN THE U.S.A. (not applicable to other areas).

## NOTICE

This equipment has been tested and found to comply with the limits for a Class B digital device, pursuant to Part 15 of the FCC Rules. These limits are designed to provide reasonable protection against harmful interference in a residential installation. This equipment generates, uses and can radiate radio frequency energy and, if not installed and used in accordance with the instructions, may cause harmful interference to radio communications. However, there is no guarantee that interference will not occur in a particular installation. If this equipment does cause harmful interference to radio or television reception, which can be determined by turning the equipment off and on, the user is encouraged to try to correct the interference by one or more of the following measures:

- Reorient or relocate the receiving antenna.
- Increase the separation between the equipment and receiver.
- Connect the equipment into an outlet on a circuit different from that to which the receiver is connected.
- Consult the dealer or an experienced radio/TV technician for help.

## FCC WARNING

Changes or modifications not expressly approved by the party responsible for compliance could void the user's authority to operate the equipment.

Proper connectors must be used for connection to host computer and/or peripherals in order to meet FCC emission limits.

Connector SB-62  
Connector FA-123

Power Graphic Unit to Power Graphic Unit  
Power Graphic Unit to PC for IBM/Macintosh Machine



**Batterij niet weggooien,  
maar inleveren als  
KCA**

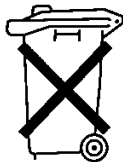

CASIO ELECTRONICS CO., LTD.  
Unit 6, 1000 North Circular Road,  
London NW2 7JD, U.K.

### Important!

Please keep your manual and all information handy for future reference.

*IBM is a registered trademark of International Business Machines Corporation.  
Macintosh is a registered trademark of Apple Computer, Inc.*

# BEFORE USING THE CALCULATOR FOR THE FIRST TIME...

This calculator does not contain any main batteries when you purchase it. Be sure to perform the following procedure to load batteries, reset the calculator, and adjust the contrast before trying to use the calculator for the first time.

1. Making sure that you do not accidentally press the **AC/ON** key, slide the case onto the calculator and then turn the calculator over. Remove the back cover from the calculator by pulling with your finger at the point marked ①.

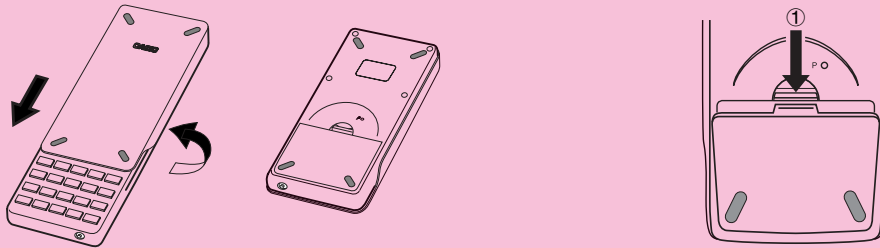

2. Load the four batteries that come with calculator.
  - Make sure that the positive (+) and negative (-) ends of the batteries are facing correctly.

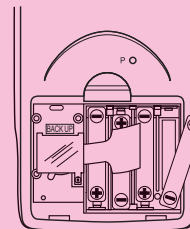

3. Remove the insulating sheet at the location marked "BACK UP" by pulling in the direction indicated by the arrow.

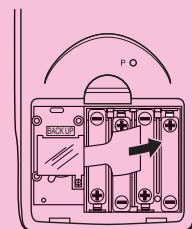

4. Replace the back cover, making sure that its tabs enter the holes marked ② and turn the calculator front side up. The calculator should automatically turn on power and perform the memory reset operation.

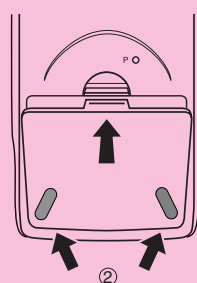

5. Press **MENU**.

- If the Main Menu shown to the right is not on the display, press the P button on the back of the calculator to perform memory reset.

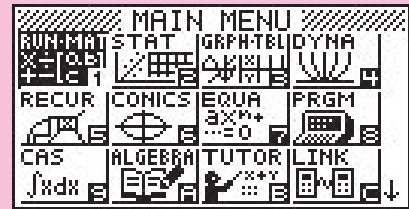
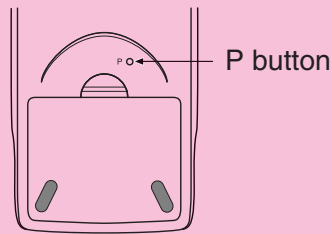

6. Use the cursor keys (**▲**, **▼**, **◀**, **▶**) to select the **SYSTEM** icon and press **EXE**, then press **F2** (**◀▶**) to display the contrast adjustment screen.



7. Adjust the contrast.

- The **▶** cursor key makes display contrast darker.
- The **◀** cursor key makes display contrast lighter.
- **F1** (INIT) returns display contrast to its initial default.

8. To exit display contrast adjustment, press **MENU**.



# Quick-Start

**Turning Power On And Off**

**Using Modes**

**Basic Calculations**

**Replay Feature**

**Fraction Calculations**

**Exponents**

**Graph Functions**

**Dual Graph**

**Box Zoom**

**Dynamic Graph**

**Table Function**





# Quick-Start

Welcome to the world of graphing calculators.

Quick-Start is not a complete tutorial, but it takes you through many of the most common functions, from turning the power on, and on to graphing complex equations. When you're done, you'll have mastered the basic operation of this calculator and will be ready to proceed with the rest of this user's guide to learn the entire spectrum of functions available.

Each step of the examples in Quick-Start is shown graphically to help you follow along quickly and easily. When you need to enter the number 57, for example, we've indicated it as follows:

Press **5** **7**

Whenever necessary, we've included samples of what your screen should look like. If you find that your screen doesn't match the sample, you can restart from the beginning by pressing the "All Clear" button **AC/ON**.

## TURNING POWER ON AND OFF

To turn power on, press **AC/ON**.

To turn power off, press **SHIFT** **AC/ON**<sup>OFF</sup>.

Calculator power turns off automatically if you do not perform any operation within the Auto Power Off trigger time you specify. You can specify either six minutes or 60 minutes as the trigger time.

## USING MODES

This calculator makes it easy to perform a wide range of calculations by simply selecting the appropriate mode. Before getting into actual calculations and operation examples, let's take a look at how to navigate around the modes.

### To select the RUN • MAT Mode

1. Press **MENU** to display the Main Menu.

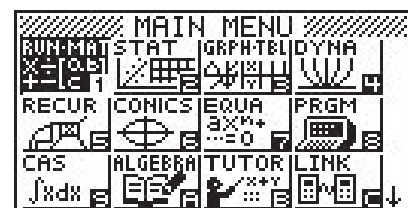



2. Use to highlight **RUN • MAT** and then press .

This is the initial screen of the RUN • MAT Mode, where you can perform manual calculations, matrix calculations, and run programs.

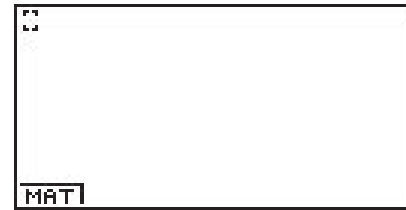

## BASIC CALCULATIONS

With manual calculations, you input formulas from left to right, just as they are written on paper. With formulas that include mixed arithmetic operators and parentheses, the calculator automatically applies true algebraic logic to calculate the result.

**Example:**  $15 \times 3 + 61$

1. Press to clear the calculator.
2. Press .

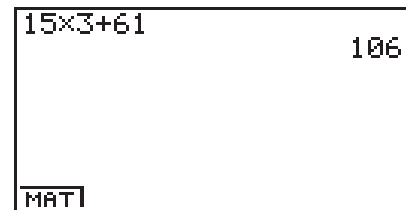

## Parentheses Calculations

**Example:**  $15 \times (3 + 61)$

1. Press .

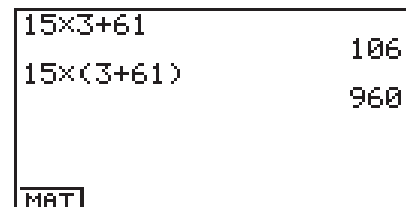

## Built-In Functions

This calculator includes a number of built-in scientific functions, including trigonometric and logarithmic functions.

**Example:**  $25 \times \sin 45^\circ$

**Important!**

**Be sure that you specify Deg (degrees) as the angle unit before you try this example.**



1. Press **CTRL** **F3** to display the SET UP screen.

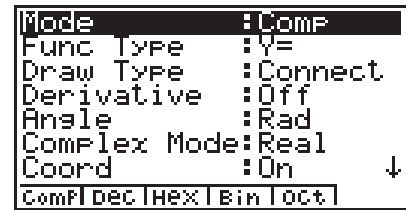

2. Press **▼** **▼** **▼** **▼** **F1** (Deg) to specify degrees as the angle unit.



3. Press **ESC** to clear the menu.

4. Press **AC/ON** to clear the unit.

5. Press **2** **5** **×** **sin** **4** **5** **EXE**.

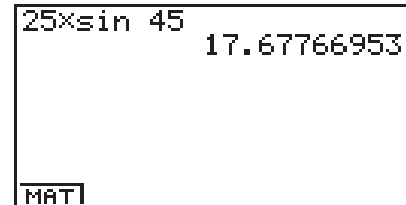

## REPLAY FEATURE

With the replay feature, simply press **◀** or **▶** to recall the last calculation that was performed so you can make changes or re-execute it as it is.

**Example:** To change the calculation in the last example from  $(25 \times \sin 45^\circ)$  to  $(25 \times \sin 55^\circ)$

1. Press **◀** to display the last calculation.
2. Press **◀** twice to move the cursor (|) to 4.
3. Press **DEL** to delete 4.
4. Press **5**.
5. Press **EXE** to execute the calculation again.

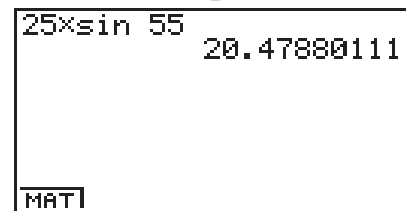
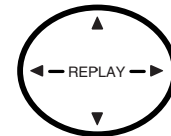





## FRACTION CALCULATIONS

You can use the  $\frac{a}{b}$  key to input fractions into calculations. The symbol “ $\downarrow$ ” is used to separate the various parts of a fraction.

**Example:**  $1 \frac{15}{16} + \frac{37}{9}$

1. Press  $\text{AC/ON}$ .

2. Press  $\frac{1}{16} + \frac{5}{7} \frac{37}{9}$ .

Indicates  $6 \frac{7}{144}$

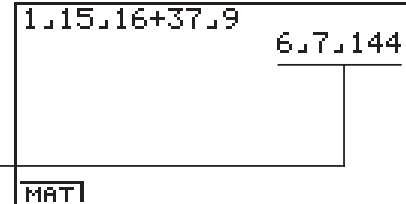

## Converting a Mixed Fraction to an Improper Fraction

While a mixed fraction is shown on the display, press  $\text{SHIFT} \frac{d/c}{a/b}$  to convert it to an improper fraction.

Press  $\text{SHIFT} \frac{d/c}{a/b}$  again to convert back to a mixed fraction.

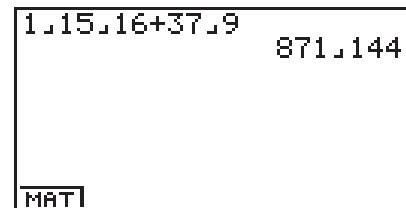

## Converting a Fraction to Its Decimal Equivalent

While a fraction is shown on the display, press  $\frac{a}{b}$  to convert it to its decimal equivalent.

Press  $\frac{a}{b}$  again to convert back to a fraction.

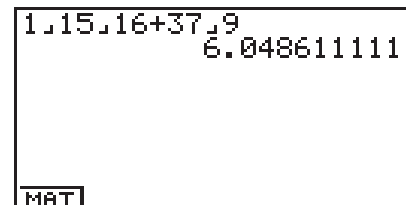



## EXPONENTS

**Example:**  $1250 \times 2.06^5$

1. Press **AC/ON**.
2. Press **1** **2** **5** **0** **X** **2** **.** **0** **6**.
3. Press **^** and the ^ indicator appears on the display.
4. Press **5**. The ^5 on the display indicates that 5 is an exponent.
5. Press **EXE**.

```
1250x2.06^5
46370.96297
MAT
```



## GRAPH FUNCTIONS

The graphing capabilities of this calculator makes it possible to draw complex graphs using either rectangular coordinates (horizontal axis:  $x$ ; vertical axis:  $y$ ) or polar coordinates (angle:  $\theta$ ; distance from origin:  $r$ ).

All of the following graphing examples are performed starting from the calculator setup in effect immediately following a reset operation.

**Example 1:** To graph  $Y = X(X + 1)(X - 2)$

1. Press **MENU**.

2. Use **◀ ▶ ▲ ▼** to highlight **GRPH • TBL**, and then press **EXE**.

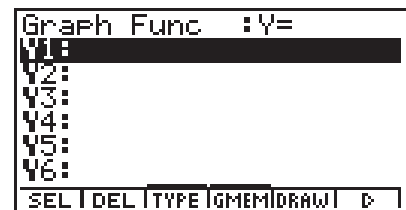

3. Input the formula.

**X,θ,T** **(** **X,θ,T** **+** **1** **)**  
**(** **X,θ,T** **-** **2** **)** **EXE**

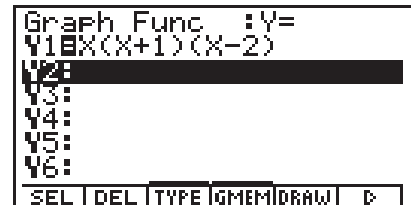

4. Press **F5** (DRAW) or **EXE** to draw the graph.

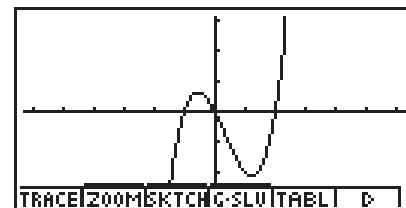

**Example 2:** To determine the roots of  $Y = X(X + 1)(X - 2)$

1. Press **F4** (G-SLV) to display the pull-up menu.

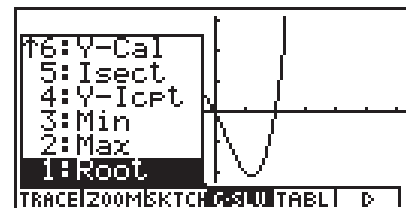



- Press **1** (Root).
- Press **▶** for other roots.

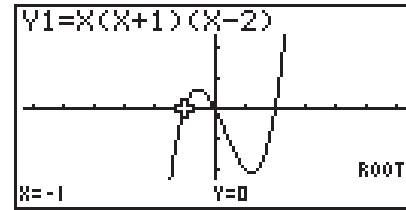

**Example 3:** Determine the area bounded by the origin and the  $X = -1$  root obtained for  $Y = X(X + 1)(X - 2)$

- Press **ESC** **F4** (G-SLV) **▼**.

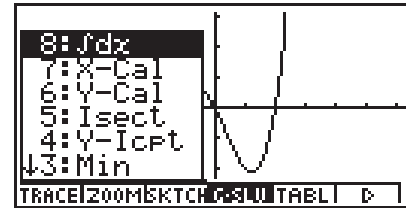

- Press **8** ( $\int dx$ ).

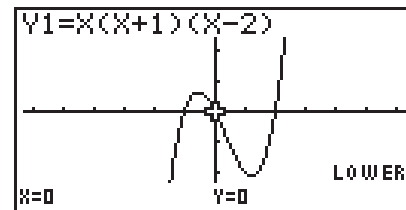

- Use **◀** to move the pointer to the location where  $X = -1$ , and then press **EXE**. Next, use **▶** to move the pointer to the location where  $X = 0$ , and then press **EXE** to input the integration range, which becomes shaded on the display.

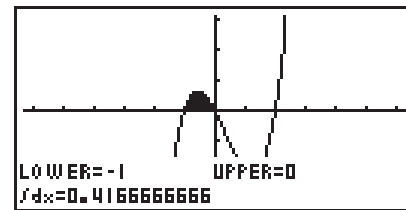



## DUAL GRAPH

With this function you can split the display between two areas and display two graphs on the same screen.

**Example:** To draw the following two graphs and determine the points of intersection

$$Y1 = X(X + 1)(X - 2)$$

$$Y2 = X + 1.2$$

1. Press **CTRL** **F3** **▼** **▼** **▼** **F2** (G+G) to specify "G+G" for the Dual Screen setting.

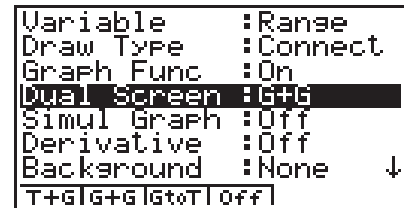

2. Press **ESC**, and then input the two functions.

**X,θ,T** **(** **X,θ,T** **+** **1** **)**  
**(** **X,θ,T** **-** **2** **)** **EXE**  
**X,θ,T** **+** **1** **•** **2** **EXE**

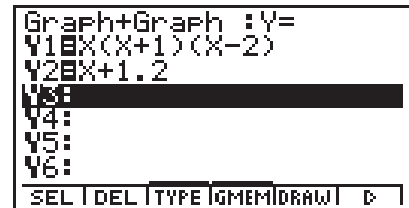

3. Press **F5** (DRAW) or **EXE** to draw the graphs.

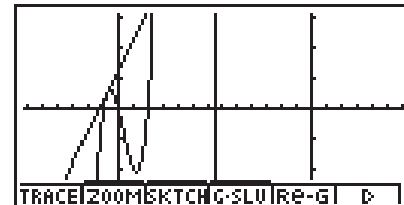

## BOX ZOOM

Use the Box Zoom function to specify areas of a graph for enlargement.

1. Press **F2** (ZOOM) **1** (Box).

2. Use **◀** **▶** **▲** **▼** to move the pointer to one corner of the area you want to specify and then press **EXE**.

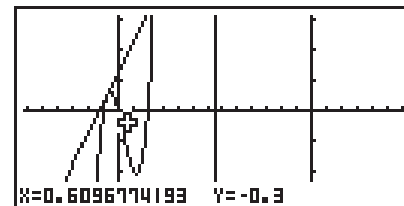



3. Use to move the pointer again. As you do, a box appears on the display. Move the pointer so the box encloses the area you want to enlarge.

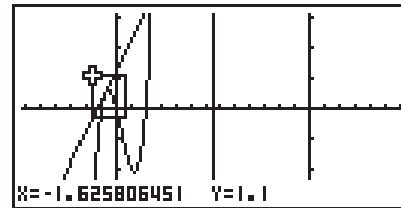

4. Press , and the enlarged area appears in the inactive (right side) screen.

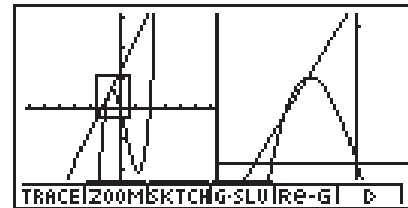

## DYNAMIC GRAPH

Dynamic Graph lets you see how the shape of a graph is affected as the value assigned to one of the coefficients of its function changes.

**Example:** To draw graphs as the value of coefficient A in the following function changes from 1 to 3

$$Y = AX^2$$

1. Press .
2. Use to highlight **DYNA**, and then press .

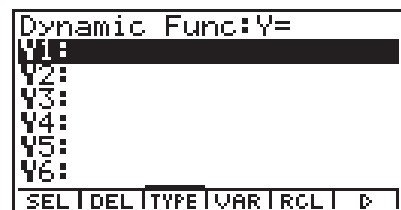

3. Input the formula.

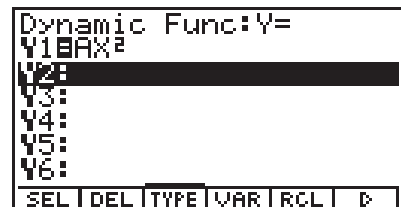



4. Press **F4** (VAR) **1** **EXE** to assign an initial value of 1 to coefficient A.

```
Y1=AX2
Dynamic Var :A / >
A=1
SEL |RANG|SPEED |DYN|
```

5. Press **F2** (RANG) **1** **EXE** **3** **EXE** **1** **EXE** to specify the range and increment of change in coefficient A.

```
Y1=AX2
Dynamic Range
A
Start:1
End :3
Pitch:1
```

6. Press **ESC**.

7. Press **F6** (DYNA) to start Dynamic Graph drawing. The graphs are drawn 10 times.

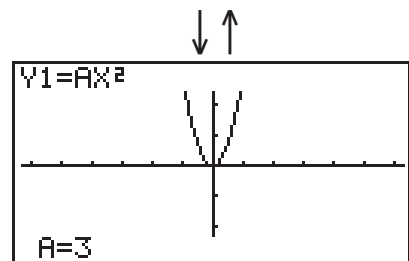
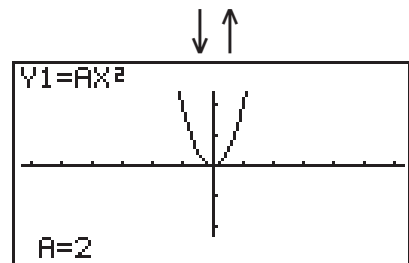
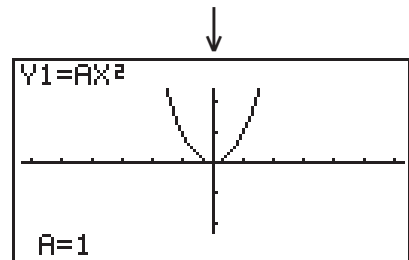



## TABLE FUNCTION

The Table Function makes it possible to generate a table of solutions as different values are assigned to the variables of a function.

**Example:** To create a number table for the following function

$$Y = X (X+1) (X-2)$$

1. Press **MENU**.

2. Use **◀ ▶ ▲ ▼** to highlight **GRPH • TBL**, and then press **EXE**.

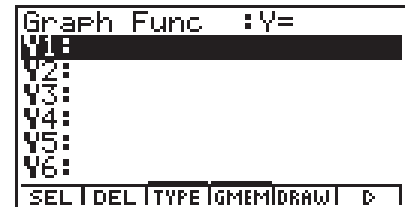

3. Input the formula.

**X,θ,T** **(** **X,θ,T** **+** **1** **)**  
**(** **X,θ,T** **-** **2** **)** **EXE**

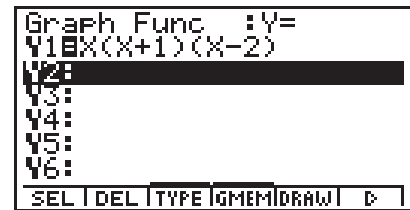

4. Press **F6** (▷) **F5** (TABL) to generate the number table.

X	Y1
1	-2
2	0
3	12
4	40

To learn all about the many powerful features of this calculator, read on and explore!





# Handling Precautions

---

- Your calculator is made up of precision components. Never try to take it apart.
- Avoid dropping your calculator and subjecting it to strong impact.
- Do not store the calculator or leave it in areas exposed to high temperatures or humidity, or large amounts of dust. When exposed to low temperatures, the calculator may require more time to display results and may even fail to operate. Correct operation will resume once the calculator is brought back to normal temperature.
- The display will go blank and keys will not operate during calculations. When you are operating the keyboard, be sure to watch the display to make sure that all your key operations are being performed correctly.
- Replace the main batteries once every 2 years regardless of how much the calculator is used during that period. Never leave dead batteries in the battery compartment. They can leak and damage the unit.
- Keep batteries out of the reach of small children. If swallowed, consult a physician immediately.
- Avoid using volatile liquids such as thinner or benzine to clean the unit. Wipe it with a soft, dry cloth, or with a cloth that has been moistened with a solution of water and a neutral detergent and wrung out.
- Always be gentle when wiping dust off the display to avoid scratching it.
- In no event will the manufacturer and its suppliers be liable to you or any other person for any damages, expenses, lost profits, lost savings or any other damages arising out of loss of data and/or formulas arising out of malfunction, repairs, or battery replacement. It is up to you to prepare physical records of data to protect against such data loss.
- Never dispose of batteries, the liquid crystal panel, or other components by burning them.
- When the “Low Main Batteries!” message or the “Low Backup battery!” message appears on the display, replace the main power supply batteries or the back up battery as soon as possible.
- Be sure that the power switch is set to OFF when replacing batteries.
- If the calculator is exposed to a strong electrostatic charge, its memory contents may be damaged or the keys may stop working. In such a case, perform the Reset operation to clear the memory and restore normal key operation.
- If the calculator stops operating correctly for some reason, use a thin, pointed object to press the P button on the back of the calculator. Note, however, that this clears all the data in calculator memory.
- Note that strong vibration or impact during program execution can cause execution to stop or can damage the calculator’s memory contents.
- Using the calculator near a television or radio can cause interference with TV or radio reception.
- Before assuming malfunction of the unit, be sure to carefully reread this user’s guide and ensure that the problem is not due to insufficient battery power, programming or operational errors.



***Be sure to keep physical records of all important data!***

Low battery power or incorrect replacement of the batteries that power the unit can cause the data stored in memory to be corrupted or even lost entirely. Stored data can also be affected by strong electrostatic charge or strong impact. It is up to you to keep back up copies of data to protect against its loss.

In no event shall CASIO Computer Co., Ltd. be liable to anyone for special, collateral, incidental, or consequential damages in connection with or arising out of the purchase or use of these materials. Moreover, CASIO Computer Co., Ltd. shall not be liable for any claim of any kind whatsoever against the use of these materials by any other party.

- The contents of this user's guide are subject to change without notice.
- No part of this user's guide may be reproduced in any form without the express written consent of the manufacturer.
- The options described in Chapter 10 of this user's guide may not be available in certain geographic areas. For full details on availability in your area, contact your nearest CASIO dealer or distributor.

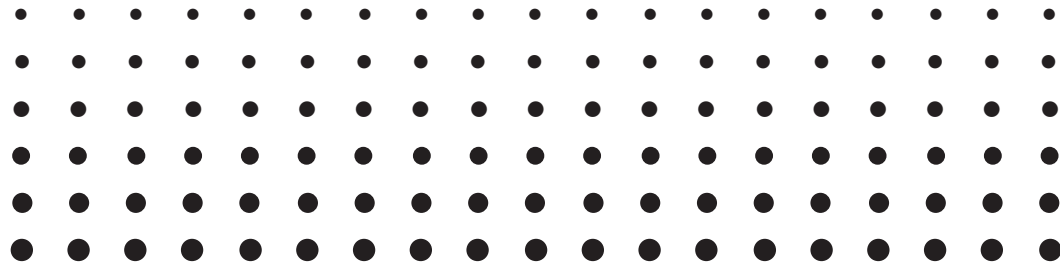

# *ALGEBRA FX 2.0*

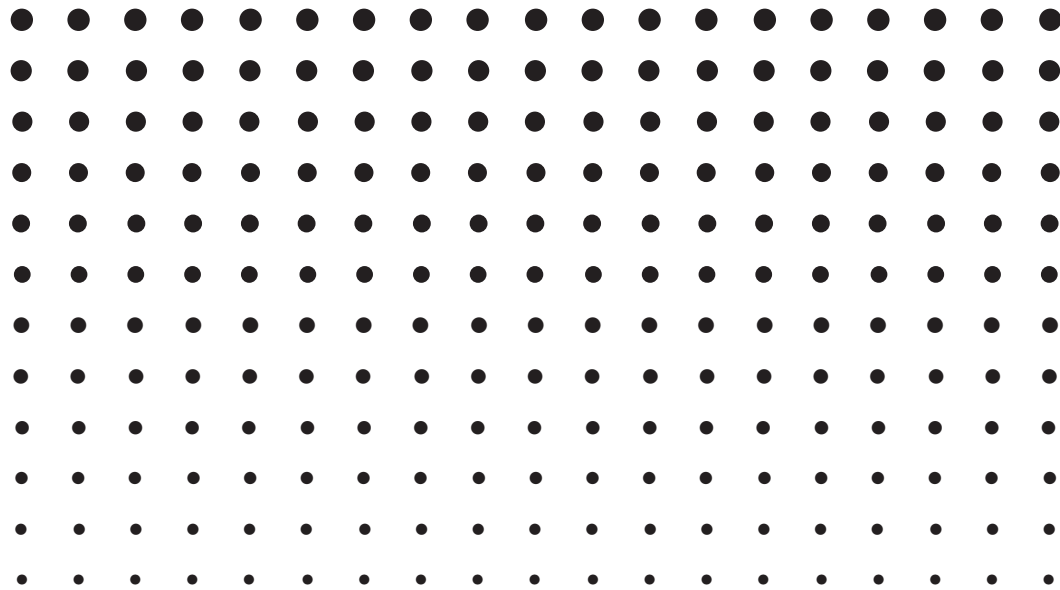



# Contents

---

## Getting Acquainted — Read This First!

### Chapter 1 Basic Operation

1-1	Keys .....	1-1-1
1-2	Display .....	1-2-1
1-3	Inputting and Editing Calculations .....	1-3-1
1-4	Option (OPTN) Menu .....	1-4-1
1-5	Variable Data (VARs) Menu .....	1-5-1
1-6	Program (PRGM) Menu .....	1-6-1
1-7	Using the Set Up Screen .....	1-7-1
1-8	When you keep having problems... ..	1-8-1

### Chapter 2 Manual Calculations

2-1	Basic Calculations .....	2-1-1
2-2	Special Functions .....	2-2-1
2-3	Specifying the Angle Unit and Display Format .....	2-3-1
2-4	Function Calculations .....	2-4-1
2-5	Numerical Calculations .....	2-5-1
2-6	Complex Number Calculations .....	2-6-1
2-7	Binary, Octal, Decimal, and Hexadecimal Calculations .....	2-7-1
2-8	Matrix Calculations .....	2-8-1

### Chapter 3 List Function

3-1	Inputting and Editing a List .....	3-1-1
3-2	Manipulating List Data .....	3-2-1
3-3	Arithmetic Calculations Using Lists .....	3-3-1
3-4	Switching Between List Files .....	3-4-1

### Chapter 4 Equation Calculations

4-1	Simultaneous Linear Equations .....	4-1-1
4-2	High Degree Equations .....	4-2-1
4-3	Solve Calculations .....	4-3-1
4-4	What to Do When an Error Occurs .....	4-4-1



## Chapter 5 Graphing

5-1	Sample Graphs .....	5-1-1
5-2	Controlling What Appears on a Graph Screen .....	5-2-1
5-3	Drawing a Graph .....	5-3-1
5-4	Storing a Graph in Picture Memory .....	5-4-1
5-5	Drawing Two Graphs on the Same Screen .....	5-5-1
5-6	Manual Graphing .....	5-6-1
5-7	Using Tables .....	5-7-1
5-8	Dynamic Graphing .....	5-8-1
5-9	Graphing a Recursion Formula .....	5-9-1
5-10	Changing the Appearance of a Graph .....	5-10-1
5-11	Function Analysis .....	5-11-1

## Chapter 6 Statistical Graphs and Calculations

6-1	Before Performing Statistical Calculations .....	6-1-1
6-2	Calculating and Graphing Single-Variable Statistical Data .....	6-2-1
6-3	Calculating and Graphing Paired-Variable Statistical Data .....	6-3-1
6-4	Performing Statistical Calculations .....	6-4-1

## Chapter 7 Computer Algebra System and Tutorial Modes

7-1	Using the CAS (Computer Algebra System) Mode .....	7-1-1
7-2	Algebra Mode .....	7-2-1
7-3	Tutorial Mode .....	7-3-1
7-4	Algebra System Precautions .....	7-4-1

## Chapter 8 Programming

8-1	Basic Programming Steps .....	8-1-1
8-2	Program Mode Function Keys .....	8-2-1
8-3	Editing Program Contents .....	8-3-1
8-4	File Management .....	8-4-1
8-5	Command Reference .....	8-5-1
8-6	Using Calculator Functions in Programs .....	8-6-1
8-7	Program Mode Command List .....	8-7-1
8-8	Program Library .....	8-8-1

## Chapter 9 System Settings Menu

9-1	Using the System Settings Menu .....	9-1-1
9-2	Memory Operations .....	9-2-1
9-3	System Settings .....	9-3-1
9-4	Reset .....	9-4-1
9-5	Tutorial Lock .....	9-5-1



**Chapter 10 Data Communications**

10-1 Connecting Two Units ..... 10-1-1  
10-2 Connecting the Unit with a CASIO Label Printer ..... 10-2-1  
10-3 Connecting the Unit to a Personal Computer ..... 10-3-1  
10-4 Performing a Data Communication Operation ..... 10-4-1  
10-5 Data Communications Precautions ..... 10-5-1  
10-6 Sending a Screen Shot ..... 10-6-1  
10-7 Add-ins ..... 10-7-1  
10-8 MEMORY Mode ..... 10-8-1

**Appendix**

1 Error Message Table .....  $\alpha$ -1-1  
2 Input Ranges .....  $\alpha$ -2-1  
3 Specifications .....  $\alpha$ -3-1  
4 Index .....  $\alpha$ -4-1  
5 Key Index .....  $\alpha$ -5-1  
6 P Button (In case of hang up) .....  $\alpha$ -6-1  
7 Power Supply .....  $\alpha$ -7-1

# Getting Acquainted

## — Read This First!

### About this User's Guide

- **SHIFT** **x<sup>2</sup>** ( $\sqrt{\quad}$ )

The above indicates you should press **SHIFT** and then **x<sup>2</sup>**, which will input a  $\sqrt{\quad}$  symbol. All multiple-key input operations are indicated like this. Key cap markings are shown, followed by the input character or command in parentheses.

### •Function Keys and Menus

- Many of the operations performed by this calculator can be executed by pressing function keys **F1** through **F6**. The operation assigned to each function key changes according to the mode the calculator is in, and current operation assignments are indicated by function menus that appear at the bottom of the display.
- This user's guide shows the current operation assigned to a function key in parentheses following the key cap for that key. **F1** (Comp), for example, indicates that pressing **F1** selects {Comp}, which is also indicated in the function menu.
- When ( $\triangleright$ ) is indicated in the function menu for key **F6**, it means that pressing **F6** displays the next page or previous page of menu options.

### •Menu Titles

- Menu titles in this user's guide include the key operation required to display the menu being explained. The key operation for a menu that is displayed by pressing **OPTN** and then {MAT} would be shown as: **[OPTN]-[MAT]**.
- **F6** ( $\triangleright$ ) key operations to change to another menu page are not shown in menu title key operations.



## • Graphs

As a general rule, graph operations are shown on facing pages, with actual graph examples on the right hand page. You can produce the same graph on your calculator by performing the steps under the Procedure above the graph.

Look for the type of graph you want on the right hand page, and then go to the page indicated for that graph. The steps under “Procedure” always use initial RESET settings.

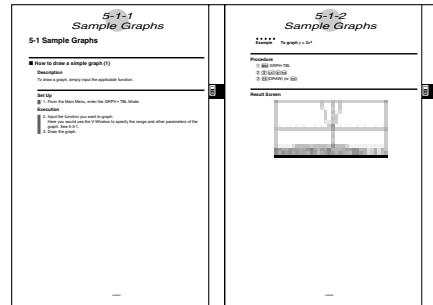

The step numbers in the “SET UP” and “Execution” sections on the left hand page correspond to the “Procedure” step numbers on the right hand page.

Example:

Left hand page

Right hand page

3. Draw the graph.

③ **F5** (DRAW)(or **EXE**)

## • Command List

The Program Mode Command List (page 8-7) provides a graphic flowchart of the various function key menus and shows how to maneuver to the menu of commands you need.

Example: The following operation displays Xfct: **[VARS]-[FACT]-[Xfct]**

## • Page Contents

Three-part page numbers are centered at the top of each page. The page number “1-2-3”, for example, indicates Chapter 1, Section 2, page 3.

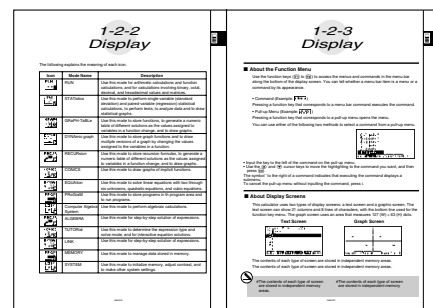

## • Supplementary Information

Supplementary information is shown at the bottom of each page in a “ (Notes)” block.

\* indicates a note about a term that appears in the same page as the note.

# indicates a note that provides general information about topic covered in the same section as the note.



# Chapter

# 1

# 1

## Basic Operation

- 1-1 Keys
- 1-2 Display
- 1-3 Inputting and Editing Calculations
- 1-4 Option (OPTN) Menu
- 1-5 Variable Data (VARs) Menu
- 1-6 Program (PRGM) Menu
- 1-7 Using the Set Up Screen
- 1-8 When you keep having problems...



# 1-1 Keys

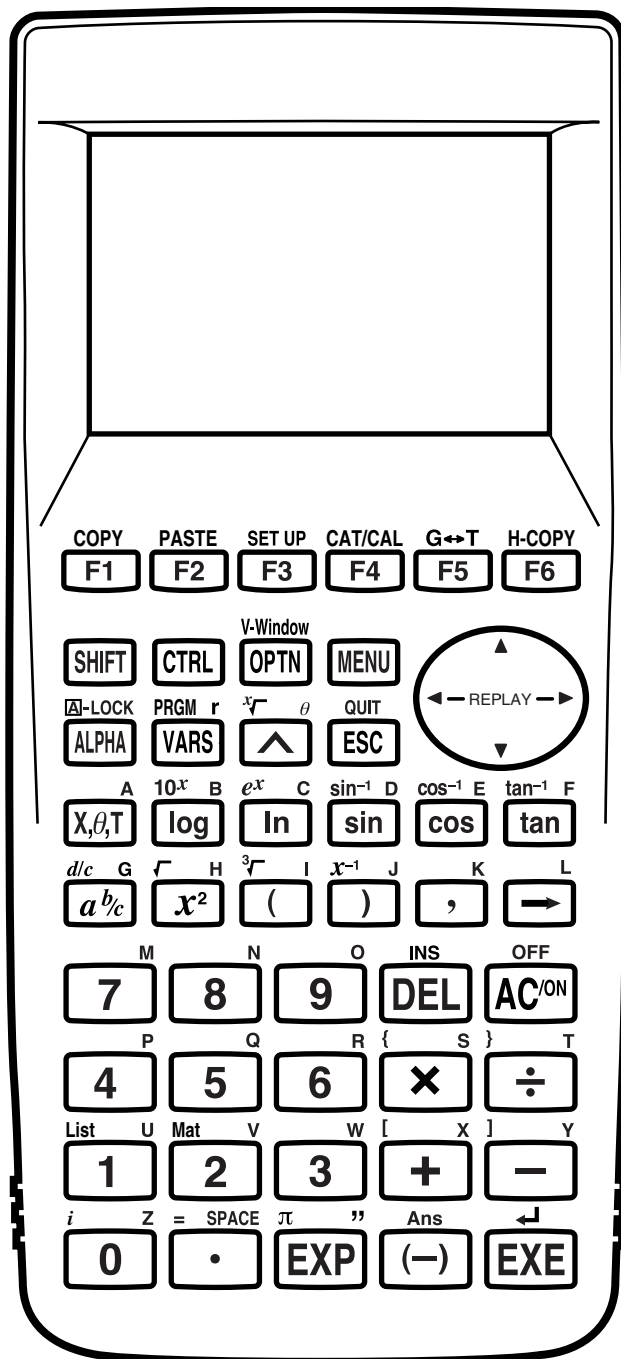



■ Key Table

	Page	Page	Page	Page	Page	Page	Page
<b>COPY</b> <b>F1</b>	1-3-5	<b>PASTE</b> <b>F2</b>	1-3-5	<b>SET UP</b> <b>F3</b>	1-7-1	<b>CAT/CAL</b> <b>F4</b>	1-3-5
<b>SHIFT</b>	1-1-3	<b>CTRL</b>	1-3-4	V-Window <b>OPTN</b>	5-2-1	<b>MENU</b>	1-2-1
<b>ALPHA</b>	1-1-3	<b>PRGM</b> r	1-6-1	$\sqrt{x}$ $\theta$	2-4-4	<b>REPLAY</b>	
<b>A</b> <b>X,θ,T</b>		<b>VAR</b>	1-5-1	$\wedge$	2-4-4	<b>QUIT</b> <b>ESC</b>	
<b>G</b> <b>a<sup>b/c</sup></b>	2-4-10	<b>10<sup>x</sup></b> B	2-4-4	$e^x$ C	2-4-4	$\sin^{-1}$ D	2-4-3
<b>H</b> <b>x<sup>2</sup></b>	2-4-10	<b>log</b>	2-4-4	$\ln$	2-4-4	<b>sin</b>	2-4-3
<b>I</b> <b>(</b>	2-4-6	<b>√</b> H	2-4-6	$\sqrt[3]{}$ I	2-4-6	<b>cos<sup>-1</sup></b> E	2-4-3
<b>J</b> <b>)</b>	2-1-1	<b>x<sup>2</sup></b>	2-4-6	<b>(</b>	2-1-1	<b>tan<sup>-1</sup></b> F	2-4-3
<b>K</b> <b>,</b>		<b>x<sup>2</sup></b>	2-4-6	<b>(</b>	2-1-1	<b>tan</b>	2-4-3
<b>L</b> <b>→</b>	2-2-1	<b>x<sup>2</sup></b>	2-4-6	<b>(</b>	2-1-1	<b>tan</b>	2-4-3
<b>M</b> <b>7</b>		<b>x<sup>2</sup></b>	2-4-6	<b>(</b>	2-1-1	<b>tan</b>	2-4-3
<b>N</b> <b>8</b>		<b>x<sup>2</sup></b>	2-4-6	<b>(</b>	2-1-1	<b>tan</b>	2-4-3
<b>O</b> <b>9</b>		<b>x<sup>2</sup></b>	2-4-6	<b>(</b>	2-1-1	<b>tan</b>	2-4-3
<b>P</b> <b>4</b>	3-1-2	<b>x<sup>2</sup></b>	2-4-6	<b>(</b>	2-1-1	<b>tan</b>	2-4-3
<b>Q</b> <b>5</b>	2-8-11	<b>x<sup>2</sup></b>	2-4-6	<b>(</b>	2-1-1	<b>tan</b>	2-4-3
<b>R</b> <b>6</b>		<b>x<sup>2</sup></b>	2-4-6	<b>(</b>	2-1-1	<b>tan</b>	2-4-3
<b>S</b> <b>x</b>	2-1-1	<b>x<sup>2</sup></b>	2-4-6	<b>(</b>	2-1-1	<b>tan</b>	2-4-3
<b>T</b> <b>÷</b>	2-1-1	<b>x<sup>2</sup></b>	2-4-6	<b>(</b>	2-1-1	<b>tan</b>	2-4-3
<b>U</b> <b>1</b>		<b>x<sup>2</sup></b>	2-4-6	<b>(</b>	2-1-1	<b>tan</b>	2-4-3
<b>V</b> <b>2</b>		<b>x<sup>2</sup></b>	2-4-6	<b>(</b>	2-1-1	<b>tan</b>	2-4-3
<b>W</b> <b>3</b>		<b>x<sup>2</sup></b>	2-4-6	<b>(</b>	2-1-1	<b>tan</b>	2-4-3
<b>X</b> <b>+</b>	2-1-1	<b>x<sup>2</sup></b>	2-4-6	<b>(</b>	2-1-1	<b>tan</b>	2-4-3
<b>Y</b> <b>-</b>	2-1-1	<b>x<sup>2</sup></b>	2-4-6	<b>(</b>	2-1-1	<b>tan</b>	2-4-3
<b>Z</b> <b>0</b>		<b>x<sup>2</sup></b>	2-4-6	<b>(</b>	2-1-1	<b>tan</b>	2-4-3
<b>INS</b> <b>DEL</b>	1-3-3	<b>x<sup>2</sup></b>	2-4-6	<b>(</b>	2-1-1	<b>tan</b>	2-4-3
<b>OFF</b> <b>AC/ON</b>	1-3-1	<b>x<sup>2</sup></b>	2-4-6	<b>(</b>	2-1-1	<b>tan</b>	2-4-3
<b>S</b> <b>{</b>	2-1-1	<b>x<sup>2</sup></b>	2-4-6	<b>(</b>	2-1-1	<b>tan</b>	2-4-3
<b>T</b> <b>÷</b>	2-1-1	<b>x<sup>2</sup></b>	2-4-6	<b>(</b>	2-1-1	<b>tan</b>	2-4-3
<b>X</b> <b>+</b>	2-1-1	<b>x<sup>2</sup></b>	2-4-6	<b>(</b>	2-1-1	<b>tan</b>	2-4-3
<b>Y</b> <b>-</b>	2-1-1	<b>x<sup>2</sup></b>	2-4-6	<b>(</b>	2-1-1	<b>tan</b>	2-4-3
<b>Ans</b> <b>(-)</b>	2-2-5	<b>x<sup>2</sup></b>	2-4-6	<b>(</b>	2-1-1	<b>tan</b>	2-4-3
<b>EXE</b>	2-1-1	<b>x<sup>2</sup></b>	2-4-6	<b>(</b>	2-1-1	<b>tan</b>	2-4-3



## ■ Key Markings

Many of the calculator's keys are used to perform more than one function. The functions marked on the keyboard are color coded to help you find the one you need quickly and easily.

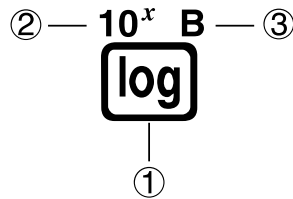

	Function	Key Operation
①	log	
②	$10^x$	
③	B	

The following describes the color coding used for key markings.

Color	Key Operation
Orange	Press  and then the key to perform the marked function.
Red	Press  and then the key to perform the marked function.



### # Alpha Lock

Normally, once you press and then a key to input an alphabetic character, the keyboard reverts to its primary functions immediately.

If you press and then , the keyboard locks in alpha input until you press again.



# 1-2 Display

## ■ Selecting Icons

This section describes how to select an icon in the Main Menu to enter the mode you want.

### ● To select an icon

1. Press **MENU** to display the Main Menu.
2. Use the cursor keys (◀, ▶, ▲, ▼) to move the highlighting to the icon you want.

Currently selected icon

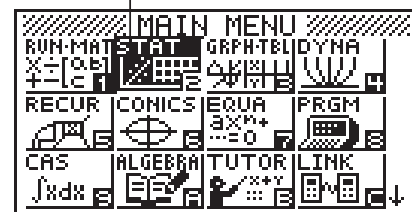

3. Press **EXE** to display the initial screen of the mode whose icon you selected.  
Here we will enter the STAT Mode.



- You can also enter a mode without highlighting an icon in the Main Menu by inputting the number or letter marked in the lower right corner of the icon.



The following explains the meaning of each icon.

Icon	Mode Name	Description
	RUN • MATrix	Use this mode for arithmetic calculations and function calculations, and for calculations involving binary, octal, decimal, and hexadecimal values and matrices.
	STATistics	Use this mode to perform single-variable (standard deviation) and paired-variable (regression) statistical calculations, to analyze data and to draw statistical graphs.
	GRaPH-TaBLe	Use this mode to store functions, to generate a numeric table of different solutions as the values assigned to variables in a function change, and to draw graphs.
	DYNAmic graph	Use this mode to store graph functions and to draw multiple versions of a graph by changing the values assigned to the variables in a function.
	RECURsion	Use this mode to store recursion formulas, to generate a numeric table of different solutions as the values assigned to variables in a function change, and to draw graphs.
	CONICS	Use this mode to draw graphs of implicit functions.
	EQUAtion	Use this mode to solve linear equations with 2 to 30 unknowns, and high degree (2 to 30) equations.
	PRoGraM	Use this mode to store programs in th program area and to run programs.
	Computer Algebra System	Use this mode to perform algebraic calculations.
	ALGEBRA	Use this mode for step-by-step solution of expressions.
	TUTORial	Use this mode to determine the expression type and solve mode, and for interactive equation solutions.
	LINK	Use this mode to transfer memory contents or back-up data to another unit.
	MEMORY	Use this mode to manage data stored in memory.
	SYSTEM	Use this mode to initialize memory, adjust contrast, and to make other system settings.



## About the Function Menu

Use the function keys (**F1**) to (**F6**) to access the menus and commands in the menu bar along the bottom of the display screen. You can tell whether a menu bar item is a menu or a command by its appearance.

- **Command** (Example: **DEAW**)

Pressing a function key that corresponds to a menu bar command executes the command.

- **Pull-up Menu** (Example: **HYP**)

Pressing a function key that corresponds to a pull-up menu opens the menu.

You can use either of the following two methods to select a command from a pull-up menu.

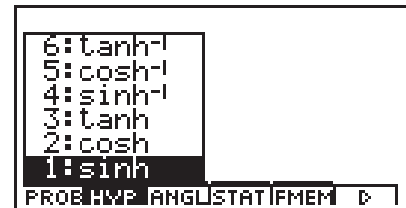

- Input the key to the left of the command on the pull-up menu.
- Use the **▲** and **▼** cursor keys to move the highlighting to the command you want, and then press **EXE**.

The symbol **▶** to the right of a command indicates that executing the command displays a submenu.

To cancel the pull-up menu without inputting the command, press **ESC**.

## About Display Screens

This calculator uses two types of display screens: a text screen and a graphic screen. The text screen can show 21 columns and 8 lines of characters, with the bottom line used for the function key menu. The graph screen uses an area that measures 127 (W) × 63 (H) dots.

Text Screen

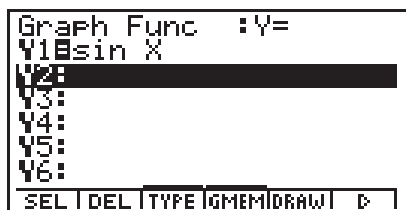

Graph Screen

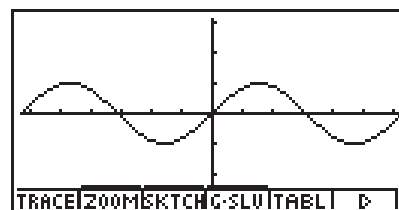

The contents of each type of screen are stored in independent memory areas.

Press **CTRL F5** (**G↔T**) to switch between the graphic screen and text screen.



# The symbol **↑** in the upper left corner of a pull-up menu indicates that there are more commands running off the top of the menu.

Use the cursor keys to scroll the menu contents to view the commands running off the top.



## ■ Normal Display

The calculator normally displays values up to 10 digits long. Values that exceed this limit are automatically converted to and displayed in exponential format.

### • How to interpret exponential format

1.2E12	1.2E+12
--------	---------

1.2E+12 indicates that the result is equivalent to  $1.2 \times 10^{12}$ . This means that you should move the decimal point in 1.2 twelve places to the right, because the exponent is positive. This results in the value 1,200,000,000,000.

1.2E-3	1.2E-03
--------	---------

1.2E-03 indicates that the result is equivalent to  $1.2 \times 10^{-3}$ . This means that you should move the decimal point in 1.2 three places to the left, because the exponent is negative. This results in the value 0.0012.

You can specify one of two different ranges for automatic changeover to normal display.

Norm 1 .....  $10^{-2}$  (0.01) > |x|, |x|  $\geq 10^{10}$

Norm 2 .....  $10^{-9}$  (0.000000001) > |x|, |x|  $\geq 10^{10}$

All of the examples in this manual show calculation results using Norm 1.

See page 2-3-2 for details on switching between Norm 1 and Norm 2.





## ■ Special Display Formats

This calculator uses special display formats to indicate fractions, hexadecimal values, and degrees/minutes/seconds values.

- Fractions

 ..... Indicates:  $456 \frac{12}{23}$

- Hexadecimal Values

 ..... Indicates:  $ABCDEF12_{(16)}$ , which equals  $-1412567278_{(10)}$

- Degrees/Minutes/Seconds

 ..... Indicates:  $12^\circ 34' 56.78''$

- In addition to the above, this calculator also uses other indicators or symbols, which are described in each applicable section of this manual as they come up.

## ■ Calculation Execution Indicator

Whenever the calculator is busy drawing a graph or executing a long, complex calculation or program, a black box "■" flashes in the upper right corner of the display. This black box tells you that the calculator is performing an internal operation.

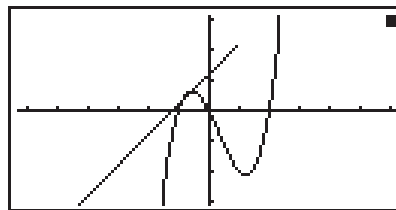



## 1-3 Inputting and Editing Calculations

### Inputting Calculations

When you are ready to input a calculation, first press **AC** to clear the display. Next, input your calculation formulas exactly as they are written, from left to right, and press **EXE** to obtain the result.

• • • • •

**Example 1**  $2 + 3 - 4 + 10 =$

**AC** **2** **+** **3** **-** **4** **+** **1** **0** **EXE**

2+3-4+10  
11

• • • • •

**Example 2**  $2(5 + 4) \div (23 \times 5) =$

**AC** **2** **(** **5** **+** **4** **)** **÷**  
**(** **2** **3** **×** **5** **)** **EXE**

2(5+4)÷(23×5)  
0.1565217391

### Editing Calculations

Use the **◀** and **▶** keys to move the cursor to the position you want to change, and then perform one of the operations described below. After you edit the calculation, you can execute it by pressing **EXE**. Or you can use **▶** to move to the end of the calculation and input more.

#### To change a step

• • • • •

**Example** To change  $\cos 60$  to  $\sin 60$

**AC** **cos** **6** **0**

cos 60

**◀** **◀** **◀**

[cos 60

**DEL**

[6]

**sin**

sin [6]



---

- To delete a step

• • • • •

**Example** To change  $369 \times \times 2$  to  $369 \times 2$

AC 3 6 9  $\times$   $\times$  2

369 $\times$  $\times$ 2

$\leftarrow$   $\leftarrow$  DEL

369 $\times$ 2

---

- To insert a step

• • • • •

**Example** To change  $2.36^2$  to  $\sin 2.36^2$

AC 2 . 3 6  $x^2$

2.36 $^2$

$\leftarrow$   $\leftarrow$   $\leftarrow$   $\leftarrow$   $\leftarrow$

2.36 $^2$

sin

sin 2.36 $^2$

---

- To change the last step you input

• • • • •

**Example** To change  $396 \times 3$  to  $396 \times 2$

AC 3 6 9  $\times$  3

369 $\times$ 3

DEL

369 $\times$

2

369 $\times$ 2

---



## Using Replay Memory

The last calculation performed is always stored into replay memory. You can recall the contents of the replay memory by pressing ◀ or ▶.

If you press ▶, the calculation appears with the cursor at the beginning. Pressing ◀ causes the calculation to appear with the cursor at the end. You can make changes in the calculation as you wish and then execute it again.



### Example 1 To perform the following two calculations

$$4.12 \times 6.4 = 26.368$$

$$4.12 \times 7.1 = 29.252$$

AC 4 . 1 2 X 6 . 4 EXE

4.12×6.4  
26.368

◀◀◀◀

4.12×6.4

SHIFT DEL (INS)

4.12×6.4

7 . 1

4.12×7.1\_

EXE

4.12×7.1  
29.252

After you press AC, you can press ▲ or ▼ to recall previous calculations, in sequence from the newest to the oldest (Multi-Replay Function). Once you recall a calculation, you can use ▶ and ◀ to move the cursor around the calculation and make changes in it to create a new calculation.



### Example 2

AC 1 2 3 + 4 5 6 EXE

123+456  
579

2 3 4 - 5 6 7 EXE

234-567  
-333

AC

☐

▲ (One calculation back)

234-567

▲ (Two calculations back)

123+456



# Pressing SHIFT DEL (INS) changes the cursor to “\_”. The next function or value you input is overwritten at the location of “\_”. To abort this operation, press SHIFT DEL (INS) again.

# A calculation remains stored in replay memory until you perform another calculation or change modes.

# The contents of replay memory are not cleared when you press the AC key, so you can recall a calculation and execute it even after performing the all clear operation.



## ■ Making Corrections in the Original Calculation



**Example**  $14 \div 0 \times 2.3$  entered by mistake for  $14 \div 10 \times 2.3$

AC 1 4  $\div$  0 X 2  $\cdot$  3

14/0x2.3

EXE

14/0x2.3

Ma ERROR

Press: [ESC]

Press [ESC].

14/0x2.3

*Cursor is positioned automatically at the location of the cause of the error.*

Make necessary changes.

◀ 1

14/10x2.3

Execute again.

EXE

14/10x2.3

3.22

## ■ Copy and Paste

You can temporarily copy commands, programs, and other text data you input to a memory area called “the clipboard,” and then paste it to another location on the display.

### • To specify the copy range

1. Move the cursor (|) the beginning or end of the range of text you want to copy and then press [CTRL]. This changes the cursor to “G”.

14/10x2.3G

2. Use the cursor keys to move the cursor and highlight the range of text you want to copy.

14/10x2.3



3. Press **CTRL** **F1** (COPY) to copy the highlighted text to the clipboard, and exit the copy range specification mode.

14/10×2.3

To cancel text highlighting without performing a copy operation, press **ESC**.

### • Pasting Text

Move the cursor to the location where you want to paste the text, and then press **CTRL** **F2** (PASTE). The contents of the clipboard are pasted at the cursor position.

**AC**

□

**CTRL** **F2** (PASTE)

14/10×2.3□

## ■ Catalog Function

The Catalog is an alphabetic list of all the commands available on this calculator. You can input a command by calling up the Catalog and then selecting the command you want.

### • To use the Catalog to input a command

1. Press **CTRL** **F4** (CAT/CAL) to display the Catalog at the bottom of the screen.

A | B | C~ | CoM | D | P |

2. Press the function key that matches the first letter of the command you want to input.  
3. Select the command from the pull-up menu.



#### Example 1 To use the Catalog to input the ClrGraph command

**AC** **CTRL** **F4** (CAT/CAL) **F3** (C~) **7** (CLR)

**1** (Graph)

ClrGraph□

A | B | C~ | CoM | D | P |

**Example 2 To use the Catalog to input the Prog command**

**AC** **CTRL** **F4** (CAT/CAL) **F6** (▷) **F6** (▷)  
**F5** (P) **In** (Prog)

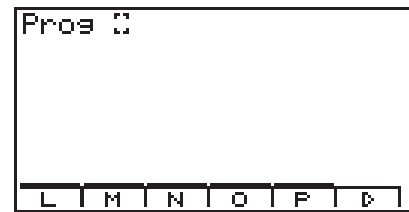

Pressing **ESC** or **SHIFT** **ESC** (QUIT) closes the Catalog.



## 1-4 Option (OPTN) Menu

The option menu gives you access to scientific functions and features that are not marked on the calculator's keyboard. The contents of the option menu differ according to the mode you are in when you press the **OPTN** key.

See "8-7 Program Mode Command List" for details on the option (OPTN) menu.

---

### • Option Menu in the RUN • MAT or PRGM Mode

- **{LIST}** ... {list function menu}
- **{MAT}** ... {matrix operation menu}
- **{CPLX}** ... {complex number calculation menu}
- **{CALC}** ... {functional analysis menu}
- **{NUM}** ... {numeric calculation menu}
- **{PROB}** ... {probability/distribution calculation menu}
- **{HYP}** ... {hyperbolic calculation menu}
- **{ANGL}** ... {menu for angle/coordinate conversion, DMS input/conversion}
- **{STAT}** ... {paired-variable statistical estimated value menu}
- **{FMEM}** ... {function memory menu}
- **{ZOOM}** ... {zoom function menu}
- **{SKTCH}** ... {sketch function menu}
- **{PICT}** ... {picture memory menu}
- **{SYBL}** ... {symbol menu}
- {° ' ''} ... {DMS}
- {← ° ' ''} ... {DMS conversion}
- **{ENG}**/{← **ENG}** ... {ENG conversion}



# The option (OPTN) menu does not appear during binary, octal, decimal, and hexadecimal calculations.





The following shows the function menus that appear under other conditions.

---

• **Option Menu when a number table value is displayed in the GRPH • TBL or RECUR Mode**

- {LMEM} ... {list memory menu}
- { $\leftarrow$  ° ' " }/{ENG}/{ $\leftarrow$  ENG}

---

• **Option Menu in the CAS or ALGEBRA or TUTOR Mode**

- { $\infty$ } ... {infinity}
- {Abs} ... {absolute value}
- {x!} ... {factorial}
- {sign} ... {signum function}
- {HYP}/{FMEM}

The meanings of the option menu items are described in the sections that cover each mode.



## 1-5 Variable Data (VARS) Menu

To recall variable data, press **[VARS]** to display the variable data menu.

**{V-WIN}/{FACT}/{STAT}/{GRPH}/{DYNA}/  
{TABL}/{RECR}/{EQUA\*1}**

See “8-7 Program Mode Command List” for details on the variable data (VARS) menu.

### • V-WIN — Recalling View Window values

- **{Xmin}/{Xmax}/{Xscale}/{Xdot}**  
... X-axis {minimum value}/{maximum value}/{scale}/{dot value\*2}
- **{Ymin}/{Ymax}/{Yscale}**  
... Y-axis {minimum value}/{maximum value}/{scale}
- **{Tθmin}/{Tθmax}/{Tθptch}**  
... T, θ {minimum value}/{maximum value}/{pitch}
- **{R-Xmin}/{R-Xmax}/{R-Xscl}/{R-Xdot}**  
... Dual Graph right graph X-axis {minimum value}/{maximum value}/{scale}/  
{dot value\*2}
- **{R-Ymin}/{R-Ymax}/{R-Yscl}**  
... Dual Graph right graph Y-axis {minimum value}/{maximum value}/{scale}
- **{R-Tmin}/{R-Tmax}/{R-Tpch}**  
... Dual Graph right graph T, θ {minimum value}/{maximum value}/{pitch}

### • FACT — Recalling zoom factors

- **{Xfact}/{Yfact}**  
... {x-axis factor}/{y-axis factor}



\*1 The EQUA item appears only when you access the variable data menu from the RUN • MAT or PRGM Mode.

# The variable data menu does not appear if you press **[VARS]** while binary, octal, decimal, or hexadecimal is set as the default number system.

\*2 The dot value indicates the display range (Xmax value – Xmin value) divided by the screen dot pitch (126).

The dot value is normally calculated automatically from the minimum and maximum values. Changing the dot value causes the maximum to be calculated automatically.



- **STAT** — Recalling statistical data

- **{n}** ... {number of data}
- **{X}** ... {single-variable, paired-variable  $x$ -data}
  - **{ $\bar{x}$ }/ $\{\Sigma x\}/\{\Sigma x^2\}/\{x_{on}\}/\{x_{on-1}\}/\{\mathbf{minX}\}/\{\mathbf{maxX}\}$**   
 ... {mean}/sum/{sum of squares}/population standard deviation/{sample standard deviation}/minimum value/maximum value
- **{Y}** ... {paired-variable  $y$ -data}
  - **{ $\bar{y}$ }/ $\{\Sigma y\}/\{\Sigma y^2\}/\{\Sigma xy\}/\{y_{on}\}/\{y_{on-1}\}/\{\mathbf{minY}\}/\{\mathbf{maxY}\}$**   
 ... {mean}/sum/{sum of squares}/sum of products of  $x$ -data and  $y$ -data/  
 population standard deviation/sample standard deviation/minimum value/  
 maximum value
- **{GRAPH}** ... {graph data menu}
  - **{a}/b/c/d/e}**  
 ... {regression coefficient and multinomial coefficients}
  - **{r}/r<sup>2</sup>}**  
 ... {correlation coefficient}
  - **{Q1}/Q3}**  
 ... {first quartile}/third quartile}
  - **{Med}/Mod}**  
 ... {median}/mode of input data
  - **{H-Strt}/H-ptch}**  
 ... histogram {start division}/pitch}
- **{PTS}** ... {summary point data menu}
  - **{x<sub>1</sub>}/y<sub>1</sub>}/x<sub>2</sub>}/y<sub>2</sub>}/x<sub>3</sub>}/y<sub>3</sub>}** ... {coordinates of summary points}



- **GRPH — Recalling Graph Functions**

- **{Yn}/r{n}**  
... {rectangular coordinate or inequality function}/polar coordinate function}
- **{Xtn}/Ytn**  
... parametric graph function {Xt}/Yt}
- **{Xn}** ... {X=constant graph function}  
(Press these keys before inputting a value to specify a storage area.)

- **DYNA — Recalling Dynamic Graph Set Up Data**

- **{Start}/End/Pitch**  
... {coefficient range start value}/coefficient range end value/coefficient value increment}

- **TABL — Recalling Table & Graph Set Up and Content Data**

- **{Start}/End/Pitch**  
... {table range start value}/table range end value/table value increment}
- **{Result<sup>\*1</sup>}**  
... {matrix of table contents}



<sup>\*1</sup> The Result item appears only when the TABL menu is displayed in the RUN•MAT or PRGM Mode.



- **RECR — Recalling Recursion Formula<sup>\*1</sup>, Table Range, and Table Content Data**

- **{FORM}** ... {recursion formula data menu}
  - $\{a_n\}/\{a_{n+1}\}/\{a_{n+2}\}/\{b_n\}/\{b_{n+1}\}/\{b_{n+2}\}/\{c_n\}/\{c_{n+1}\}/\{c_{n+2}\}$   
...  $\{a_n\}/\{a_{n+1}\}/\{a_{n+2}\}/\{b_n\}/\{b_{n+1}\}/\{b_{n+2}\}/\{c_n\}/\{c_{n+1}\}/\{c_{n+2}\}$  expressions
- **{RANGE}** ... {table range data menu}
  - **{R-Strt}/\{R-End}**  
... table range {start value}/\{end value}
  - $\{a_0\}/\{a_1\}/\{a_2\}/\{b_0\}/\{b_1\}/\{b_2\}/\{c_0\}/\{c_1\}/\{c_2\}$   
...  $\{a_0\}/\{a_1\}/\{a_2\} \{b_0\}/\{b_1\}/\{b_2\}/\{c_0\}/\{c_1\}/\{c_2\}$  value
  - **{a<sub>n</sub>Strt}/\{b<sub>n</sub>Strt}/\{c<sub>n</sub>Strt}**  
... origin of  $\{a_n\}/\{b_n\}/\{c_n\}$  recursion formula convergence/divergence graph (WEB graph)
- **{Result<sup>\*2</sup>}** ... {matrix of table contents<sup>\*3</sup>}

- **EQUA — Recalling Equation Coefficients and Solutions<sup>\*4 \*5</sup>**

- **{S-Rslt}/\{S-Coef}**  
... matrix of {solutions}/\{coefficients} for linear equations<sup>\*6</sup>
- **{P-Rslt}/\{P-Coef}**  
... matrix of {solution}/\{coefficients} for a high degree equation



<sup>\*1</sup> An error occurs when there is no function or recursion formula numeric table in memory.

<sup>\*2</sup> "Result" is available only in the RUN • MAT and PRGM Modes.

<sup>\*3</sup> Table contents are stored automatically in Matrix Answer Memory (MatAns).

<sup>\*4</sup> Coefficients and solutions are stored automatically in Matrix Answer Memory (MatAns).

<sup>\*5</sup> The following conditions cause an error.

— When there are no coefficients input for the equation

— When there are no solutions obtained for the equation

<sup>\*6</sup> Coefficient and solution memory data for a linear equation cannot be recalled at the same time.



## 1-6 Program (PRGM) Menu

To display the program (PRGM) menu, first enter the **RUN•MAT** or **PRGM** Mode from the Main Menu and then press **SHIFT** **VAR** (PRGM). The following are the selections available in the program (PRGM) menu.

- **{Prog}** ..... {program recall}
- **{JUMP}** ..... {jump command menu}
- **{?}** ..... {input prompt}
- **{▲}** ..... {output command}
- **{I/O}** ..... {I/O control/transfer command menu}
- **{IF}** ..... {conditional jump command menu}
- **{FOR}** ..... {loop control command menu}
- **{WHILE}** ..... {conditional loop control command menu}
- **{CTRL}** ..... {program control command menu}
- **{LOGIC}** ..... {logical operation command menu}
- **{CLR}** ..... {clear command menu}
- **{DISP}** ..... {display command menu}
- **{:}** ..... {multistatement connector}

The following function key menu appears if you press **SHIFT** **VAR** (PRGM) in the **RUN•MAT** Mode or the **PRGM** Mode while binary, octal, decimal, or hexadecimal is set as the default number system.

- **{Prog}{JUMP}{?}{▲}{:}**
- **{= ≠ <}** ..... {relational operator menu}

The functions assigned to the function keys are the same as those in the **Comp** Mode.

For details on the commands that are available in the various menus you can access from the program menu, see “8. Programming”.



## 1-7 Using the Set Up Screen

The mode's set up screen shows the current status of mode settings and lets you make any changes you want. The following procedure shows how to change a set up.

### • To change a mode set up

1. Select the icon you want and press **[EXE]** enter a mode and display its initial screen. Here we will enter the RUN•MAT Mode.

2. Press **[CTRL] [F3]** (SET UP) to display the mode's SET UP screen.

- This SET UP screen is just one possible example. Actual SET UP screen contents will differ according to the mode you are in and that mode's current settings.

```

Mode           :Comp
Func Type      :Y=
Draw Type      :Connect
Derivative     :Off
Angle          :Rad
Complex Mode   :Real
Coord          :On      ↓
Compl Dec Hex Bin Oct
  
```

⋮

```

Angle          :Rad      ↑
Complex Mode   :Real
Coord          :On
Grid           :Off
Axes           :On
Label         :Off
Display       :Norml
Fix Sci Norml Eng
  
```

3. Use the **▲** and **▼** cursor keys to move the highlighting to the item whose setting you want to change.
4. Press the function key (**[F1]** to **[F6]**) that is marked with the setting you want to make.
5. After you are finished making any changes you want, press **[ESC]** to return to the initial screen of the mode.

### ■ SET UP Screen Function Key Menus

This section details the settings you can make using the function keys in the SET UP display.

~~~~~ indicates default setting.

#### • Mode (calculation/binary, octal, decimal, hexadecimal mode)

- **{Comp}** ... {arithmetic calculation mode}
- **{Dec}**/**{Hex}**/**{Bin}**/**{Oct}**  
... {decimal}/{hexadecimal}/{binary}/{octal}



- **Func Type (graph function type)**

Pressing one of the following function keys also switches the function of the  $\boxed{X.\theta T}$  key.

- $\boxed{Y=}$ / $\boxed{r=}$ / $\boxed{\text{Parm}}$ / $\boxed{X=c}$   
... {rectangular coordinate}/{polar coordinate}/{parametric coordinate}/  
{X = constant} graph
- $\boxed{Y>}$ / $\boxed{Y<}$ / $\boxed{Y\geq}$ / $\boxed{Y\leq}$   
...  $\{y>f(x)\}$ / $\{y<f(x)\}$ / $\{y\geq f(x)\}$ / $\{y\leq f(x)\}$  inequality graph

- **Draw Type (graph drawing method)**

- $\boxed{\text{Con}}$ / $\boxed{\text{Plot}}$   
... {connected points}/{unconnected points}

- **Derivative (derivative value display)**

- $\boxed{\text{On}}$ / $\boxed{\text{Off}}$   
... {display on}/{display off} while Graph-to-Table, Table & Graph, and Trace are being used

- **Angle (default angle unit)**

- $\boxed{\text{Deg}}$ / $\boxed{\text{Rad}}$ / $\boxed{\text{Gra}}$   
... {degrees}/{radians}/{grads}

- **Complex Mode**

- $\boxed{\text{Real}}$  ... {calculation in real number range only}
- $\boxed{a + bi}$ / $\boxed{r \cdot e^{\theta i}}$   
... {rectangular format}/{polar format} display of a complex calculation

- **Coord (graph pointer coordinate display)**

- $\boxed{\text{On}}$ / $\boxed{\text{Off}}$   
... {display on}/{display off}

- **Grid (graph gridline display)**

- $\boxed{\text{On}}$ / $\boxed{\text{Off}}$   
... {display on}/{display off}

- **Axes (graph axis display)**

- $\boxed{\text{On}}$ / $\boxed{\text{Off}}$   
... {display on}/{display off}

- **Label (graph axis label display)**

- $\boxed{\text{On}}$ / $\boxed{\text{Off}}$   
... {display on}/{display off}





- **Display (display format)**
  - $\{\text{Fix}\}/\{\text{Sci}\}/\{\text{Norm}\}/\{\text{Eng}\}$   
 ... {fixed number of decimal places specification}/{number of significant digits specification}/{normal display setting}/{Engineering Mode}
- **Stat Wind (statistical graph view window setting method)**
  - $\{\text{Auto}\}/\{\text{Man}\}$   
 ... {automatic}/{manual}
- **Reside List (residual calculation)**
  - $\{\text{None}\}/\{\text{LIST}\}$   
 ... {no calculation}/{list specification for the calculated residual data}
- **List File (list file display settings)**
  - $\{\text{FILE}\}$  ... {settings of list file on the display}
- **Variable (table generation and graph draw settings)**
  - $\{\text{Rang}\}/\{\text{LIST}\}$   
 ... {use table range}/{use list data}
- **Graph Func (function display during graph drawing and trace)**
  - $\{\text{On}\}/\{\text{Off}\}$   
 ... {display on}/{display off}
- **Dual Screen (Dual Screen Mode status)**
  - $\{\text{T+G}\}/\{\text{G+G}\}/\{\text{GtoT}\}/\{\text{Off}\}$   
 ... {graph on one side and numeric table on the other side of Dual Screen}/  
 {graphing on both sides of Dual Screen}/{graph on one side and numeric table  
 on the other side of Dual Screen}/{Dual Screen off}
- **Simul Graph (simultaneous graphing mode)**
  - $\{\text{On}\}/\{\text{Off}\}$   
 ... {simultaneous graphing on (all graphs drawn simultaneously)}/{simultaneous  
 graphing off (graphs drawn in area numeric sequence)}
- **Background (graph display background)**
  - $\{\text{None}\}/\{\text{PICT}\}$   
 ... {no background}/{graph background picture specification}



- **Dynamic Type (Dynamic Graph locus setting)**
  - **{Cnt}/{Stop}**  
... {non-stop (continuous)}/{automatic stop after 10 draws}
  
- **$\Sigma$  Display ( $\Sigma$  value display in recursion table)**
  - **{On}/{Off}**  
... {display on}/{display off}
  
- **Slope (display of derivative at current pointer location in implicit function graph)**
  - **{On}/{Off}**  
... {display on}/{display off}
  
- **Answer Type (result range specification)**
  - **{Real}/{Cplx}**  
... {real number}/{complex number} range result
  
- **H-Copy (screen shot settings)**
  - **{Direct}/{Mem}**  
... {direct send}/{store in memory}



## 1-8 When you keep having problems...

If you keep having problems when you are trying to perform operations, try the following before assuming that there is something wrong with the calculator.

---

### ■ Getting the Calculator Back to its Original Mode Settings

1. From the Main Menu, enter the SYSTEM Mode.
2. Press **F5** (Reset).
3. Press **F1** (S/U), and then press **EXE** (Yes).
4. Press **MENU** to return to the Main Menu.

Now enter the correct mode and perform your calculation again, monitoring the results on the display.

---

### ■ In Case of Hang Up

- Should the unit hang up and stop responding to input from the keyboard, press the P button on the back of the calculator to reset the calculator to its initial defaults (see page  $\alpha$ -6-1). Note, however, that this may clear all the data in calculator memory.



## ■ Low Battery Message

If either of the following messages appears on the display, immediately turn off the calculator and replace main batteries or the back up battery as instructed.

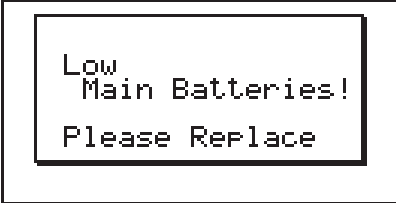

```
Low  
Main Batteries!  
Please Replace
```

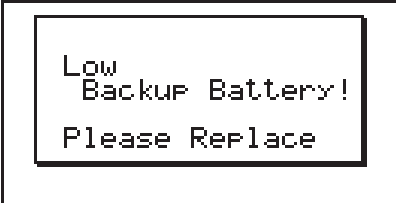

```
Low  
Backup Battery!  
Please Replace
```

If you continue using the calculator without replacing main batteries, power will automatically turn off to protect memory contents. Once this happens, you will not be able to turn power back on, and there is the danger that memory contents will be corrupted or lost entirely.



# You will not be able to perform data communications operations after the low battery message appears.

# If main batteries and the back up battery go low at the same time (indicated when both of the messages described above appear), replace the back up battery first and then replace the main batteries.

**Chapter**

**2**

**2**

# **Manual Calculations**

- 2-1 Basic Calculations**
- 2-2 Special Functions**
- 2-3 Specifying the Angle Unit and Display Format**
- 2-4 Function Calculations**
- 2-5 Numerical Calculations**
- 2-6 Complex Number Calculations**
- 2-7 Binary, Octal, Decimal, and Hexadecimal Calculations**
- 2-8 Matrix Calculations**



## 2-1 Basic Calculations

### ■ Arithmetic Calculations

- Enter arithmetic calculations as they are written, from left to right.
- Use the  $\boxed{(-)}$  key to input the minus sign before a negative value.
- Calculations are performed internally with a 15-digit mantissa. The result is rounded to a 10-digit mantissa before it is displayed.
- For mixed arithmetic calculations, multiplication and division are given priority over addition and subtraction.

| Example                               | Operation                                                                                                                                            |
|---------------------------------------|------------------------------------------------------------------------------------------------------------------------------------------------------|
| $23 + 4.5 - 53 = -25.5$               | $23 \boxed{+} 4.5 \boxed{-} 53 \boxed{EXE}$                                                                                                          |
| $56 \times (-12) \div (-2.5) = 268.8$ | $56 \boxed{\times} \boxed{(-)} 12 \boxed{\div} \boxed{(-)} 2.5 \boxed{EXE}$                                                                          |
| $(2 + 3) \times 10^2 = 500$           | $\boxed{(} 2 \boxed{+} 3 \boxed{)} \boxed{\times} 1 \boxed{EXP} 2 \boxed{EXE}^{*1}$                                                                  |
| $1 + 2 - 3 \times 4 \div 5 + 6 = 6.6$ | $1 \boxed{+} 2 \boxed{-} 3 \boxed{\times} 4 \boxed{\div} 5 \boxed{+} 6 \boxed{EXE}$                                                                  |
| $100 - (2 + 3) \times 4 = 80$         | $100 \boxed{-} \boxed{(} 2 \boxed{+} 3 \boxed{)} \boxed{\times} 4 \boxed{EXE}$                                                                       |
| $2 + 3 \times (4 + 5) = 29$           | $2 \boxed{+} 3 \boxed{\times} \boxed{(} 4 \boxed{+} 5 \boxed{)} \boxed{EXE}^{*2}$                                                                    |
| $(7 - 2) \times (8 + 5) = 65$         | $\boxed{(} 7 \boxed{-} 2 \boxed{)} \boxed{(} 8 \boxed{+} 5 \boxed{)} \boxed{EXE}^{*3}$                                                               |
| $\frac{6}{4 \times 5} = 0.3$          | $6 \boxed{\div} \boxed{(} 4 \boxed{\times} 5 \boxed{)} \boxed{EXE}^{*4}$                                                                             |
| $(1 + 2i) + (2 + 3i) = 3 + 5i$        | $\boxed{(} 1 \boxed{+} 2 \boxed{SHIFT} 0 \boxed{(i)} \boxed{)} \boxed{+} \boxed{(} 2 \boxed{+} 3 \boxed{SHIFT} 0 \boxed{(i)} \boxed{)} \boxed{EXE}$  |
| $(2 + i) \times (2 - i) = 5$          | $\boxed{(} 2 \boxed{+} \boxed{SHIFT} 0 \boxed{(i)} \boxed{)} \boxed{\times} \boxed{(} 2 \boxed{-} \boxed{SHIFT} 0 \boxed{(i)} \boxed{)} \boxed{EXE}$ |



\*1  $\boxed{(} 2 \boxed{+} 3 \boxed{)} \boxed{EXP} 2$  does not produce the correct result. Be sure to enter this calculation as shown.

\*2 Final closed parentheses (immediately before operation of the  $\boxed{EXE}$  key) may be omitted, no matter how many are required.

\*3 A multiplication sign immediately before an open parenthesis may be omitted.

\*4 This is identical to  $6 \boxed{\div} 4 \boxed{\div} 5 \boxed{EXE}$ .



## ■ Number of Decimal Places, Number of Significant Digits, Normal Display Range

[SET UP]- [Display]- [Fix]/[Sci]/[Norm]

- Even after you specify the number of decimal places or the number of significant digits, internal calculations are still performed using a 15-digit mantissa, and displayed values are stored with a 10-digit mantissa. Use Rnd of the Numeric Calculation Menu (NUM) (page 2-4-1) to round the displayed value off to the number of decimal place and number of significant digit settings.
- Number of decimal place (Fix) and number of significant digit (Sci) settings normally remain in effect until you change them or until you change the normal display range (Norm) setting.



**Example**     $100 \div 6 = 16.66666666\dots$

| Condition             | Operation                                                                            | Display                                 |
|-----------------------|--------------------------------------------------------------------------------------|-----------------------------------------|
|                       | $100 \div 6$ [EXE]                                                                   | <b>16.66666667</b>                      |
| 4 decimal places      | [CTRL] [F3] (SET UP) [▼][▼][▼][▼][▼][▼][▼][▼][▼]<br>[F1] (Fix) [4] [EXE] [ESC] [EXE] | <b>16.6667</b> <sup>*1</sup>            |
| 5 significant digits  | [CTRL] [F3] (SET UP) [▼][▼][▼][▼][▼][▼][▼][▼][▼]<br>[F2] (Sci) [5] [EXE] [ESC] [EXE] | <b>1.6667</b> <sup>*1</sup> <b>E+01</b> |
| Cancels specification | [CTRL] [F3] (SET UP) [▼][▼][▼][▼][▼][▼][▼][▼][▼]<br>[F3] (Norm) [ESC] [EXE]          | <b>16.66666667</b>                      |



\*1 Displayed values are rounded off to the place you specify.



**Example**  $200 \div 7 \times 14 = 400$



| Condition                                                 | Operation                                                                                        | Display                     |
|-----------------------------------------------------------|--------------------------------------------------------------------------------------------------|-----------------------------|
| 3 decimal places                                          | $200 \div 7 \times 14$ [EXE]                                                                     | 400                         |
|                                                           | [CTRL] [F3] (SET UP) [v] [v] [v] [v] [v] [v] [v] [v] [v] [v]<br>[F1] (Fix) [3] [EXE] [ESC] [EXE] | 400.000                     |
| Calculation continues using display capacity of 10 digits | $200 \div 7$ [EXE]                                                                               | 28.571                      |
|                                                           | [X] [14] [EXE]                                                                                   | Ans $\times$ [ ]<br>400.000 |

• If the same calculation is performed using the specified number of digits:

|                                                                                     |                                   |                             |
|-------------------------------------------------------------------------------------|-----------------------------------|-----------------------------|
| The value stored internally is cut off to the number of decimal places you specify. | $200 \div 7$ [EXE]                | 28.571                      |
|                                                                                     | [OPTN] [F5] (NUM) [4] (Rnd) [EXE] | 28.571                      |
|                                                                                     | [X] [14] [EXE]                    | Ans $\times$ [ ]<br>399.994 |

## ■ Calculation Priority Sequence

This calculator employs true algebraic logic to calculate the parts of a formula in the following order:

- ① Coordinate transformation Pol  $(x, y)$ , Rec  $(r, \theta)$   
Differentials, quadratic differentials, integrations,  $\Sigma$  calculations  
 $d/dx$ ,  $d^2/dx^2$ ,  $\int dx$ ,  $\Sigma$ , Mat, Solve, FMin, FMax, List  $\rightarrow$  Mat, Seq, Min, Max, Median, Mean, Augment, Mat  $\rightarrow$  List, P(, Q(, R(, t(, List
- ② Type A functions  
With these functions, the value is entered and then the function key is pressed.  
 $x^2$ ,  $x^{-1}$ ,  $x!$ ,  $^\circ$ ,  $'$ ,  $''$ , ENG symbols, angle unit  $^\circ$ ,  $'$ ,  $''$
- ③ Power/root  $\wedge(x^y)$ ,  $\sqrt[x]{\quad}$
- ④ Fractions  $a^b/c$
- ⑤ Abbreviated multiplication format in front of  $\pi$ , memory name, or variable name.  
 $2\pi$ , 5A, Xmin, F Start, etc.
- ⑥ Type B functions  
With these functions, the function key is pressed and then the value is entered.  
 $\sqrt{\quad}$ ,  $\sqrt[3]{\quad}$ , log, ln,  $e^x$ ,  $10^x$ , sin, cos, tan,  $\sin^{-1}$ ,  $\cos^{-1}$ ,  $\tan^{-1}$ , sinh, cosh, tanh,  $\sinh^{-1}$ ,  $\cosh^{-1}$ ,  $\tanh^{-1}$ , (–), d, h, b, o, Neg, Not, Det, Trn, Dim, Identity, Sum, Prod, Cuml, Percent,  $\Delta$ List, Abs, Int, Frac, Intg, Arg, Conjg, ReP, ImP





- ⑦ Abbreviated multiplication format in front of Type B functions  
 $2\sqrt{3}$ ,  $A \log 2$ , etc.
- ⑧ Permutation, combination  $nPr$ ,  $nCr$
- ⑨  $\times$ ,  $\div$
- ⑩  $+$ ,  $-$
- ⑪ Relational operators  $>$ ,  $<$ ,  $\geq$ ,  $\leq$
- ⑫ Relational operators  $=$ ,  $\neq$
- ⑬ and (bit operation)
- ⑭ xnor, xor (bit operations)
- ⑮ or (bit operation)
- ⑯ And (logical operation)
- ⑰ Or (logical operation)



**Example**  $2 + 3 \times (\log \sin 2\pi^2 + 6.8) = 22.07101691$  (angle unit = Rad)

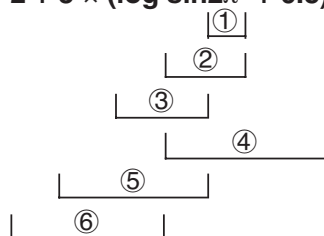

# When functions with the same priority are used in series, execution is performed from right to left.

$$e^x \ln \sqrt{120} \rightarrow e^x \{\ln(\sqrt{120})\}$$

Otherwise, execution is from left to right.

# Compound functions are executed from right to left.

# Anything contained within parentheses receives highest priority.



## ■ Multiplication Operations without a Multiplication Sign

You can omit the multiplication sign ( $\times$ ) in any of the following operations.

- Before coordinate transformation and Type B functions (① and ⑥ on page 2-1-3), except for negative signs

● ● ● ● ●

**Example**  $2\sin 30$ ,  $10\log 1.2$ ,  $2\sqrt{\quad}$ ,  $2\text{Pol}(5, 12)$ , etc.

- Before constants, variable names, memory names

● ● ● ● ●

**Example**  $2\pi$ ,  $2AB$ ,  $3\text{Ans}$ ,  $3Y_1$ , etc.

- Before an open parenthesis

● ● ● ● ●

**Example**  $3(5 + 6)$ ,  $(A + 1)(B - 1)$ , etc.

## ■ Overflow and Errors

Exceeding a specified input or calculation range, or attempting an illegal input causes an error message to appear on the display. Further operation of the calculator is impossible while an error message is displayed. The following events cause an error message to appear on the display.

- When any result, whether intermediate or final, or any value in memory exceeds  $\pm 9.999999999 \times 10^{99}$  (Ma ERROR).
- When an attempt is made to perform a function calculation that exceeds the input range (Ma ERROR).
- When an illegal operation is attempted during statistical calculations (Ma ERROR). For example, attempting to obtain 1VAR without data input.
- When an improper data type is specified for the argument of a function calculation (Ma ERROR).
- When the capacity of the numeric value stack or command stack is exceeded (Stack ERROR). For example, entering 25 successive  $\square$  followed by 2  $\oplus$  3  $\otimes$  4  $\boxtimes$ .
- When an attempt is made to perform a calculation using an illegal formula (Syntax ERROR). For example, 5  $\otimes$   $\otimes$  3  $\boxtimes$ .



# Other errors can occur during program execution. Most of the calculator's keys are inoperative while an error message is displayed.

Press  $\boxtimes$  to clear the error and display the error position (see page 1-3-4).

# See the "Error Message Table" on page  $\alpha$ -1-1 for information on other errors.



- When you try to perform a calculation that causes memory capacity to be exceeded (Memory ERROR).
- When you use a command that requires an argument, without providing a valid argument (Argument ERROR).
- When an attempt is made to use an illegal dimension during matrix calculations (Dimension ERROR).
- When an attempt is made to perform a calculation that has a real number argument and produces a complex number solution, while “Real” is selected for the Complex Mode setting on the SET UP Screen (Non-Real ERROR).

## ■ Memory Capacity

Each time you press a key, either one byte or two bytes is used. Some of the functions that require one byte are:  $\boxed{1}$ ,  $\boxed{2}$ ,  $\boxed{3}$ , sin, cos, tan, log, ln,  $\sqrt{\quad}$ , and  $\pi$ . Some of the functions that take up two bytes are  $d/dx$ , Mat, Xmin, If, For, Return, DrawGraph, SortA(), PxlOn, Sum, and  $a_{n+1}$ .



# As you input numeric values or commands, they appear flush left on the display. Calculation results, on the other hand, are displayed flush right.

# The allowable range for both input and output values is 15 digits for the mantissa and two digits for the exponent. Internal calculations are also performed using a 15-digit mantissa and two-digit exponent.

## 2-2 Special Functions



### ■ Calculations Using Variables

| Example               | Operation                                     | Display |
|-----------------------|-----------------------------------------------|---------|
|                       | $193.2 \rightarrow$ [ALPHA] [X,θ,T] (A) [EXE] | 193.2   |
| $193.2 \div 23 = 8.4$ | [ALPHA] [X,θ,T] (A) [÷] 23 [EXE]              | 8.4     |
| $193.2 \div 28 = 6.9$ | [ALPHA] [X,θ,T] (A) [÷] 28 [EXE]              | 6.9     |

### ■ Memory

#### ● Variables

This calculator comes with 28 variables as standard. You can use variables to store values you want to use inside of calculations. Variables are identified by single-letter names, which are made up of the 26 letters of the alphabet, plus  $r$  and  $\theta$ . The maximum size of values that you can assign to variables is 15 digits for the mantissa and 2 digits for the exponent.

#### ● To assign a value to a variable

[value]  $\rightarrow$  [variable name] [EXE]



**Example** To assign 123 to variable A

[AC] [1] [2] [3]  $\rightarrow$  [ALPHA] [X,θ,T] (A) [EXE]

123→A 123



**Example** To add 456 to variable A and store the result in variable B

[AC] [ALPHA] [X,θ,T] (A) [+] [4] [5] [6]  $\rightarrow$  [ALPHA] [log] (B) [EXE]

A+456→B 579



# Variable contents are retained even when you turn power off.



• To display the contents of a variable

• • • • •

Example To display the contents of variable A

AC ALPHA X,θ,T (A) EXE      A 123

• To clear a variable

• • • • •

Example To clear variable A

AC 0 → ALPHA X,θ,T (A) EXE      0→A 0

• To assign the same value to more than one variable

[value] → [first variable name<sup>\*1</sup>] OPTN F6 (▷) F6 (▷) F4 (SYBL) 3 (~) [last variable name<sup>\*1</sup>] EXE

• • • • •

Example To assign a value of 10 to variables A through F

AC 1 0 → ALPHA X,θ,T (A)      10→A~F 10  
OPTN F6 (▷) F6 (▷) F4 (SYBL) 3 (~)  
ALPHA tan (F) EXE

• Function Memory

[OPTN]-[FMEM]

Function memory (f<sub>1</sub>~f<sub>20</sub>) is convenient for temporary storage of often-used expressions. For longer term storage, we recommend that you use the GRPH • TBL Mode for expressions and the PRGM Mode for programs.

- {Store}/{Recall}/{fn}/{SEE} ... {function store}/{function recall}/{function area specification as a variable name inside an expression}/{function list}



<sup>\*1</sup> You cannot use “r” or “θ” as a variable name.



• To store a function

• • • • •

**Example** To store the function  $(A+B)(A-B)$  as function memory number 1

$\left[ \left( \right) \right]$   $\left[ \text{ALPHA} \right]$   $\left[ X, \theta, T \right]$   $\left[ A \right]$   $\left[ + \right]$   $\left[ \text{ALPHA} \right]$   $\left[ \log \right]$   $\left[ B \right]$   $\left[ \right]$

$(A+B)(A-B)$

$\left[ \left( \right) \right]$   $\left[ \text{ALPHA} \right]$   $\left[ X, \theta, T \right]$   $\left[ A \right]$   $\left[ - \right]$   $\left[ \text{ALPHA} \right]$   $\left[ \log \right]$   $\left[ B \right]$   $\left[ \right]$

$\left[ \text{OPTN} \right]$   $\left[ F6 \right]$   $\left[ \triangleright \right]$   $\left[ F5 \right]$  (FMEM)

== Function Memory ==  
f1: (A+B)(A-B)

$\left[ 1 \right]$  (Store)  $\left[ 1 \right]$   $\left[ \text{EXE} \right]$

• To recall a function

• • • • •

**Example** To recall the contents of function memory number 1

$\left[ \text{OPTN} \right]$   $\left[ F6 \right]$   $\left[ \triangleright \right]$   $\left[ F5 \right]$  (FMEM)

$(A+B)(A-B)$

$\left[ 2 \right]$  (Recall)  $\left[ 1 \right]$   $\left[ \text{EXE} \right]$

• To display a list of available functions

$\left[ \text{OPTN} \right]$   $\left[ F6 \right]$   $\left[ \triangleright \right]$   $\left[ F5 \right]$  (FMEM)

$\left[ 4 \right]$  (SEE)

== Function Memory ==  
f1: (A+B)(A-B)  
f2:  
f3:  
f4:  
f5:  
f6:  
STO|RCL|fn|



# If the function memory number to which you store a function already contains a function, the previous function is replaced with the new one.

# The recalled function appears at the current location of the cursor on the display.



• **To delete a function**

• • • • •

**Example** To delete the contents of function memory number 1

**AC** **OPTN** **F6**(▷) **F5**(FMEM)  
**1** (Store) **1** **EXE**

```
== Function Memory ==
f1:
```

- Executing the store operation while the display is blank deletes the function in the function memory you specify.

• **To use stored functions**

• • • • •

**Example** To store  $x^3 + 1$ ,  $x^2 + x$  into function memory, and then graph:

$$y = x^3 + x^2 + x + 1$$

Use the following View Window settings.

**Xmin = - 4, Xmax = 4, Xscale = 1**

**Ymin = -10, Ymax = 10, Yscale = 1**

**CTRL** **F3** (SET UP) **▼** **F1** (Y=) **ESC**

**AC** **X,θ,T** **∧** **3** **+** **1** **OPTN** **F6**(▷) **F5**(FMEM) **1** (Store) **1** **EXE** (stores  $x^3 + 1$ )

**ESC** **AC** **X,θ,T** **x<sup>2</sup>** **+** **X,θ,T** **F5**(FMEM) **1** (Store) **2** **EXE** (stores  $x^2 + x$ )

**ESC** **AC** **OPTN** **F6**(▷) **F6**(▷) **F2**(SKTCH) **1** (Cls) **EXE**

**F2**(SKTCH) **4**(GRAPH) **1**(Y=)

**OPTN** **F6**(▷) **F5**(FMEM) **3**(fn) **1** **+**

**F5**(FMEM) **3**(fn) **2** **EXE**

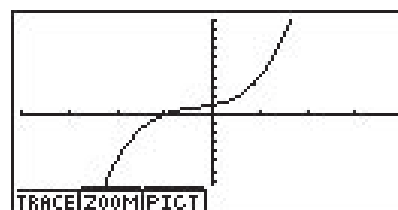

- For full details about graphing, see “5. Graphing”.



## ■ Answer Function

The Answer Function automatically stores the last result you calculated by pressing **EXE** (unless the **EXE** key operation results in an error). The result is stored in the answer memory.

### • To use the contents of the answer memory in a calculation

• • • • •

**Example**     $123 + 456 = 579$   
 $789 - 579 = 210$

**AC** **1** **2** **3** **+** **4** **5** **6** **EXE**  
**7** **8** **9** **-** **SHIFT** **(←)** **(Ans)** **EXE**

|         |     |
|---------|-----|
| 123+456 |     |
| 789-Ans | 579 |
|         | 210 |

## ■ Performing Continuous Calculations

Answer memory also lets you use the result of one calculation as one of the arguments in the next calculation.

• • • • •

**Example 1**     $1 \div 3 =$   
 $1 \div 3 \times 3 =$

**AC** **1** **÷** **3** **EXE**  
(Continuing) **×** **3** **EXE**

|       |              |
|-------|--------------|
| 1/3   |              |
| Ans×3 | 0.3333333333 |
|       | 1            |

Continuous calculations can also be used with Type A functions ( $x^2$ ,  $x^{-1}$ ,  $x!$ , page 2-1-3), +, -,  $\wedge(x^y)$ ,  $\sqrt[x]{\quad}$ ,  $^\circ$ , etc.



# The largest value that the answer memory can hold is 15 digits for the mantissa and 2 digits for the exponent.  
# Only numeric values and calculation results can be stored in answer memory.

# Answer memory contents are not cleared when you press the **AC** key or when you switch power off.  
# Answer memory contents are not changed by an operation that assigns values to value memory (such as: **5** **→** **ALPHA** **X,θ,T** **(A)** **EXE**).





## Stacks

The unit employs memory blocks, called *stacks*, for storage of low priority values and commands. There is a 10-level *numeric value stack*, a 26-level *command stack*, and a 10-level *program subroutine stack*. An error occurs if you perform a calculation so complex that it exceeds the capacity of available numeric value stack or command stack space, or if execution of a program subroutine exceeds the capacity of the subroutine stack.

● ● ● ● ●  
**Example**

$$2 \times ( ( 3 + 4 \times ( 5 + 4 ) \div 3 ) \div 5 ) + 8 =$$

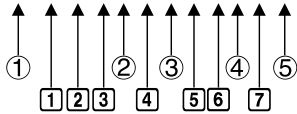

**Numeric Value Stack**

|   |   |
|---|---|
| ① | 2 |
| ② | 3 |
| ③ | 4 |
| ④ | 5 |
| ⑤ | 4 |
| ⋮ |   |

**Command Stack**

|   |   |
|---|---|
| ① | × |
| ② | ( |
| ③ | ( |
| ④ | + |
| ⑤ | × |
| ⑥ | ( |
| ⑦ | + |
| ⋮ |   |



# Calculations are performed according to the priority sequence. Once a calculation is executed, it is cleared from the stack.

# Storing a complex number takes up two numeric value stack levels.

# Storing a two-byte function takes up two command stack levels.



## ■ Using Multistatements

Multistatements are formed by connecting a number of individual statements for sequential execution. You can use multistatements in manual calculations and in programmed calculations. There are two different ways that you can use to connect statements to form multistatements.

- **Colon (:)**

Statements that are connected with colons are executed from left to right, without stopping.

- **Display Result Command (▲)**

When execution reaches the end of a statement followed by a display result command, execution stops and the result up to that point appears on the display. You can resume execution by pressing the **EXE** key.

• • • • •

**Example**      $6.9 \times 123 = 848.7$   
                    $123 \div 3.2 = 38.4375$

|                                                                                                                                                                                                                                                                                                                                                                                                   |                                                                                                                                                                                                                                                                                                                                       |
|---------------------------------------------------------------------------------------------------------------------------------------------------------------------------------------------------------------------------------------------------------------------------------------------------------------------------------------------------------------------------------------------------|---------------------------------------------------------------------------------------------------------------------------------------------------------------------------------------------------------------------------------------------------------------------------------------------------------------------------------------|
| <p> <b>AC</b> <b>1</b> <b>2</b> <b>3</b> <b>→</b> <b>ALPHA</b> <b>X,θ,T</b> (A)<br/> <b>SHIFT</b> <b>VARS</b> (PRGM) <b>F6</b> (▷) <b>F6</b> (▷) <b>F3</b> (: ) <b>6</b> <b>□</b> <b>9</b><br/> <b>×</b> <b>ALPHA</b> <b>X,θ,T</b> (A) <b>SHIFT</b> <b>VARS</b> (PRGM) <b>F4</b> (▲)<br/> <b>ALPHA</b> <b>X,θ,T</b> (A) <b>÷</b> <b>3</b> <b>□</b> <b>2</b> <b>EXE</b><br/> <br/> <b>EXE</b> </p> | <div style="border: 1px solid black; padding: 5px; width: fit-content;"> <p>123+A:6.9×A<br/>A/3.2</p> <p style="text-align: right;">848.7<br/>- Disp -</p> </div><br><div style="border: 1px solid black; padding: 5px; width: fit-content;"> <p>123+A:6.9×A<br/>A/3.2</p> <p style="text-align: right;">848.7<br/>38.4375</p> </div> |
|---------------------------------------------------------------------------------------------------------------------------------------------------------------------------------------------------------------------------------------------------------------------------------------------------------------------------------------------------------------------------------------------------|---------------------------------------------------------------------------------------------------------------------------------------------------------------------------------------------------------------------------------------------------------------------------------------------------------------------------------------|



# The final result of a multistatement is always displayed, regardless of whether the calculation ends with a display result command.

# You cannot construct a multistatement in which one statement directly uses the result of the previous statement.

Example :  $123 \times 456 : \times 5$

|  
Invalid

## 2-3 Specifying the Angle Unit and Display Format



Before performing a calculation for the first time, you should use the SET UP screen to specify the angle unit and display format.

### ■ Setting the Angle Unit

[SET UP]- [Angle]

1. On the Set Up screen, highlight “Angle”.
2. Press the function key for the angle unit you want to specify, then press  $\boxed{\text{ESC}}$ .
  - {Deg}/{Rad}/{Gra} ... {degrees}/{radians}{grads}
  - The relationship between degrees, grads, and radians is shown below.

$$360^\circ = 2\pi \text{ radians} = 400 \text{ grads}$$

$$90^\circ = \pi/2 \text{ radians} = 100 \text{ grads}$$

### ■ Setting the Display Format

[SET UP]- [Display]

1. On the Set Up screen, highlight “Display”.
2. Press the function key for the item you want to set, then press  $\boxed{\text{ESC}}$ .
  - {Fix}/{Sci}/{Norm}/{Eng} ... {fixed number of decimal places specification}/  
{number of significant digits specification}/{normal display}/{Engineering Mode}

#### • To specify the number of decimal places (Fix)



**Example**      To specify two decimal places

$\boxed{\text{F1}}$ (Fix)  $\boxed{2}$   $\boxed{\text{EXE}}$

$\boxed{\text{Display}}$       :Fix2

Press the function key that corresponds to the number of decimal places you want to specify ( $n = 0$  to 9).



# Displayed values are rounded off to the number of decimal places you specify.

### • To specify the number of significant digits (Sci)

• • • • •

**Example** To specify three significant digits

**F2**(Sci) **3** **EXE**

Display :Sci3

Press the function key that corresponds to the number of significant digits you want to specify ( $n = 0$  to  $9$ ).

### • To specify the normal display (Norm 1/Norm 2)

Press **F3** (Norm) to switch between Norm 1 and Norm 2.

**Norm 1:**  $10^{-2}$  ( $0.01$ )  $> |x|$ ,  $|x| \geq 10^{10}$

**Norm 2:**  $10^{-9}$  ( $0.000000001$ )  $> |x|$ ,  $|x| \geq 10^{10}$

**AC** **1** **÷** **2** **0** **0** **EXE** →  $1/200$   $5E-03$  (Norm 1)  
 →  $1/200$   $0.005$  (Norm 2)

### • To specify the engineering notation display (Eng Mode)

Press **F4** (Eng) to switch between engineering notation and standard notation. The indicator “/E” is on the display while engineering notation is in effect.

You can use the following symbols to convert values to engineering notation, such as  $2,000 (= 2 \times 10^3) \rightarrow 2k$ .

|          |                  |               |                   |
|----------|------------------|---------------|-------------------|
| E (Exa)  | $\times 10^{18}$ | m (milli)     | $\times 10^{-3}$  |
| P (Peta) | $\times 10^{15}$ | $\mu$ (micro) | $\times 10^{-6}$  |
| T (Tera) | $\times 10^{12}$ | n (nano)      | $\times 10^{-9}$  |
| G (Giga) | $\times 10^9$    | p (pico)      | $\times 10^{-12}$ |
| M (Mega) | $\times 10^6$    | f (femto)     | $\times 10^{-15}$ |
| k (kilo) | $\times 10^3$    |               |                   |



# Displayed values are rounded off to the number of significant digits you specify.  
 # Specifying 0 makes the number of significant digits 10.

# The engineering symbol that makes the mantissa a value from 1 to 1000 is automatically selected by the calculator when engineering notation is in effect.

## 2-4 Function Calculations



### ■ Function Menus

This calculator includes five function menus that give you access to scientific functions not printed on the key panel.

- The contents of the function menu differ according to the mode you entered from the Main Menu before you pressed the **[OPTN]** key. The following examples show function menus that appear in the RUN • MAT Mode.

#### • **Numeric Calculations (NUM)** [OPTN]-[NUM]

- **{Abs}** ... {select this item and input a value to obtain the absolute value of the value.}
- **{Int}/**{Frac}**** ... select the item and input a value to extract the {integer}/**{fraction}** part.
- **{Rnd}** ... {rounds off the value used for internal calculations to 10 significant digits (to match the value in the Answer Memory), or to the number of decimal places (Fix) and number of significant digits (Sci) specified by you.}
- **{Intg}** ... {select this item and input a value to obtain the largest integer that is not greater than the value.}
- **{E-SYM}** ... {engineering symbol}
  - **{m}/**{μ}/**{n}/**{p}/**{f}****** ... {milli ( $10^{-3}$ )/**{micro** ( $10^{-6}$ )/**{nano** ( $10^{-9}$ )/**{pico** ( $10^{-12}$ )/**{femto** ( $10^{-15}$ )}****
  - **{k}/**{M}/**{G}/**{T}/**{P}/**{E}****** ... {kilo ( $10^3$ )/**{mega** ( $10^6$ )/**{giga** ( $10^9$ )/**{tera** ( $10^{12}$ )/**{peta** ( $10^{15}$ )/**{exa** ( $10^{18}$ )}******

#### • **Probability/Distribution Calculations (PROB)** [OPTN]-[PROB]

- **{x!}** ... {press after inputting a value to obtain the factorial of the value.}
- **{nPr}/**{nCr}**** ... {permutation}/**{combination}**
- **{Ran#}**... {pseudo random number generation (0 to 1)}
- **{P}/**{Q}/**{R}**** ... probability **{P(t)}/**{Q(t)}/**{R(t)}********
- **{t}** ... {value of normalized variate  $t(x)$ }



● **Hyperbolic Calculations (HYP)** [OPTN]-[HYP]

- {sinh}/{cosh}/{tanh} ... hyperbolic {sine}/{cosine}/{tangent}
- {sinh<sup>-1</sup>}/{cosh<sup>-1</sup>}/{tanh<sup>-1</sup>} ... inverse hyperbolic {sine}/{cosine}/{tangent}

● **Angle Units, Coordinate Conversion, Sexagesimal Operations (ANGL)** [OPTN]-[ANGL]

- {°}/{r}/{g} ... {degrees}/{radians}/{grads} for a specific input value
- {° ' ''} ... {specifies degrees (hours), minutes, seconds when inputting a degrees/minutes/seconds value}
- {►DMS} ... {converts decimal value to sexagesimal value}
- {Pol()}/{Rec()} ... {rectangular-to-polar}/{polar-to-rectangular} coordinate conversion

● **Instant Functions**

- {◀° ' ''} ... {converts decimal value to degrees/minutes/seconds value}
- {ENG}/{◀ENG} ... shifts the decimal place of the displayed value three digits to the {left}/{right} and {decreases}/{increases} the exponent by three.  
When you are using engineering notation, the engineering symbol is also changed accordingly.
- The {◀° ' ''}, {ENG} and {◀ENG} menu operations are available only when there is a calculation result on the display.

■ **Angle Units**

To change the angle unit of an input value, first press [OPTN] [F3] (ANGL). On the pull-up menu that appears, select “o”, “r”, or “g”.

- Be sure to specify Comp for Mode in the SET UP screen.

| Example                                        | Operation                                                                                               |
|------------------------------------------------|---------------------------------------------------------------------------------------------------------|
| To convert 4.25 rad to degrees:<br>243.5070629 | [CTRL] [F3] (SET UP) [▼] [▼] [▼] [▼] [F1] (Deg) [ESC]<br>4.25 [OPTN] [F6] (▷) [F3] (ANGL) [2] (r) [EXE] |
| 47.3° + 82.5rad = 4774.20181°                  | 47.3 [+ ] 82.5 [OPTN] [F6] (▷) [F3] (ANGL) [2] (r) [EXE]                                                |



# Once you specify an angle unit, it remains in effect until you specify a different one.

The specification is retained even if you turn power off.



## ■ Trigonometric and Inverse Trigonometric Functions

- Be sure to set the angle unit before performing trigonometric function and inverse trigonometric function calculations.

$$(90^\circ = \frac{\pi}{2} \text{ radians} = 100 \text{ grads})$$

- Be sure to specify Comp for Mode in the SET UP screen.

| Example                                                       | Operation                                                                                                                                                                                                                                    |
|---------------------------------------------------------------|----------------------------------------------------------------------------------------------------------------------------------------------------------------------------------------------------------------------------------------------|
| $\sin 63^\circ = 0.8910065242$                                | <b>CTRL</b> <b>F3</b> (SET UP) $\blacktriangledown$ $\blacktriangledown$ $\blacktriangledown$ $\blacktriangledown$ <b>F1</b> (Deg) <b>ESC</b><br><b>sin</b> <b>63</b> <b>EXE</b>                                                             |
| $\cos \left(\frac{\pi}{3} \text{ rad}\right) = 0.5$           | <b>CTRL</b> <b>F3</b> (SET UP) $\blacktriangledown$ $\blacktriangledown$ $\blacktriangledown$ $\blacktriangledown$ <b>F2</b> (Rad) <b>ESC</b><br><b>cos</b> <b>(</b> <b>SHIFT</b> <b>EXP</b> ( $\pi$ ) <b>÷</b> <b>3</b> <b>)</b> <b>EXE</b> |
| $\tan (-35\text{gra}) = -0.6128007881$                        | <b>CTRL</b> <b>F3</b> (SET UP) $\blacktriangledown$ $\blacktriangledown$ $\blacktriangledown$ $\blacktriangledown$ <b>F3</b> (Gra) <b>ESC</b><br><b>tan</b> <b>(-)</b> <b>35</b> <b>EXE</b>                                                  |
| $2 \cdot \sin 45^\circ \times \cos 65^\circ = 0.5976724775$   | <b>CTRL</b> <b>F3</b> (SET UP) $\blacktriangledown$ $\blacktriangledown$ $\blacktriangledown$ $\blacktriangledown$ <b>F1</b> (Deg) <b>ESC</b><br><b>2</b> <b>X</b> <b>sin</b> <b>45</b> <b>X</b> <b>cos</b> <b>65</b> <b>EXE</b> *1          |
| $\operatorname{cosec} 30^\circ = \frac{1}{\sin 30^\circ} = 2$ | <b>1</b> <b>÷</b> <b>sin</b> <b>30</b> <b>EXE</b>                                                                                                                                                                                            |
| $\sin^{-1} 0.5 = 30^\circ$<br>( $x$ when $\sin x = 0.5$ )     | <b>SHIFT</b> <b>sin</b> ( $\sin^{-1}$ ) <b>0.5</b> *2 <b>EXE</b>                                                                                                                                                                             |



\*1 **X** can be omitted.

\*2 Input of leading zero is not necessary.



## ■ Logarithmic and Exponential Functions

- Be sure to specify Comp for Mode in the SET UP screen.

| Example                                                                             | Operation                                                                                                                                        |
|-------------------------------------------------------------------------------------|--------------------------------------------------------------------------------------------------------------------------------------------------|
| $\log 1.23$ ( $\log_{10} 1.23$ ) = $8.990511144 \times 10^{-2}$                     | <b>log</b> <b>1.23</b> <b>EXE</b>                                                                                                                |
| $\ln 90$ ( $\log_e 90$ ) = 4.49980967                                               | <b>ln</b> <b>90</b> <b>EXE</b>                                                                                                                   |
| $10^{1.23}$ = 16.98243652<br>(To obtain the antilogarithm of common logarithm 1.23) | <b>SHIFT</b> <b>log</b> ( <b>10<sup>x</sup></b> ) <b>1.23</b> <b>EXE</b>                                                                         |
| $e^{4.5}$ = 90.0171313<br>(To obtain the antilogarithm of natural logarithm 4.5)    | <b>SHIFT</b> <b>ln</b> ( <b>e<sup>x</sup></b> ) <b>4.5</b> <b>EXE</b>                                                                            |
| $(-3)^4$ = $(-3) \times (-3) \times (-3) \times (-3)$ = 81                          | <b>(-)</b> <b>3</b> <b>)</b> <b>^</b> <b>4</b> <b>EXE</b>                                                                                        |
| $-3^4$ = $-(3 \times 3 \times 3 \times 3)$ = -81                                    | <b>(-)</b> <b>3</b> <b>^</b> <b>4</b> <b>EXE</b>                                                                                                 |
| $\sqrt[7]{123}$ (= $123^{\frac{1}{7}}$ ) = 1.988647795                              | <b>7</b> <b>SHIFT</b> <b>^</b> ( <b>x<sup>y</sup></b> ) <b>123</b> <b>EXE</b>                                                                    |
| $2 + 3 \times \sqrt[3]{64} - 4$ = 10                                                | <b>2</b> <b>+</b> <b>3</b> <b>×</b> <b>3</b> <b>SHIFT</b> <b>^</b> ( <b>x<sup>y</sup></b> ) <b>64</b> <b>=</b> <b>4</b> <b>EXE</b> <sup>*1</sup> |



\*1  $\wedge$  ( $x^y$ ) and  $\sqrt[x]{\quad}$  take precedence over multiplication and division.





## ■ Hyperbolic and Inverse Hyperbolic Functions

- Be sure to specify Comp for Mode in the SET UP screen.

| Example                                                                                                                         | Operation                                                                                                                                                                                                                                                                                                     |
|---------------------------------------------------------------------------------------------------------------------------------|---------------------------------------------------------------------------------------------------------------------------------------------------------------------------------------------------------------------------------------------------------------------------------------------------------------|
| $\sinh 3.6 = 18.28545536$                                                                                                       | $\boxed{\text{OPTN}} \boxed{\text{F6}} (\triangleright) \boxed{\text{F2}} (\text{HYP}) \boxed{1} (\sinh) \boxed{3.6} \boxed{\text{EXE}}$                                                                                                                                                                      |
| $\cosh 1.5 - \sinh 1.5$<br>$= 0.2231301601$<br>$= e^{-1.5}$ (Display: $-1.5$ )<br>(Proof of $\cosh x \pm \sinh x = e^{\pm x}$ ) | $\boxed{\text{OPTN}} \boxed{\text{F6}} (\triangleright) \boxed{\text{F2}} (\text{HYP}) \boxed{2} (\cosh) \boxed{1.5} \boxed{-}$<br>$\boxed{\text{F2}} (\text{HYP}) \boxed{1} (\sinh) \boxed{1.5} \boxed{\text{EXE}}$<br>$\boxed{\text{In}} \boxed{\text{SHIFT}} (\leftarrow) (\text{Ans}) \boxed{\text{EXE}}$ |
| $\cosh^{-1} \left( \frac{20}{15} \right) = 0.7953654612$                                                                        | $\boxed{\text{OPTN}} \boxed{\text{F6}} (\triangleright) \boxed{\text{F2}} (\text{HYP}) \boxed{5} (\cosh^{-1}) \boxed{\left[ \right]} \boxed{20} \boxed{\div} \boxed{15} \boxed{\right]} \boxed{\text{EXE}}$                                                                                                   |
| Determine the value of $x$<br>when $\tanh 4x = 0.88$<br>$x = \frac{\tanh^{-1} 0.88}{4}$ $= 0.3439419141$                        | $\boxed{\text{OPTN}} \boxed{\text{F6}} (\triangleright) \boxed{\text{F2}} (\text{HYP}) \boxed{6} (\tanh^{-1}) \boxed{0.88} \boxed{\div} \boxed{4} \boxed{\text{EXE}}$                                                                                                                                         |



## Other Functions

- Be sure to specify Comp for Mode in the SET UP screen.

| Example                                                               | Operation                                                                                                          |
|-----------------------------------------------------------------------|--------------------------------------------------------------------------------------------------------------------|
| $\sqrt{2} + \sqrt{5} = 3.65028154$                                    | $\text{SHIFT } [x^2] (\sqrt{\phantom{x}}) 2 + \text{SHIFT } [x^2] (\sqrt{\phantom{x}}) 5 \text{ EXE}$              |
| $\sqrt{(3+i)} = 1.755317302 + 0.2848487846i$                          | $\text{SHIFT } [x^2] (\sqrt{\phantom{x}}) [C] 3 + \text{SHIFT } [0] (i) [C] \text{ EXE}$                           |
| $(-3)^2 = (-3) \times (-3) = 9$                                       | $[C] (-) 3 [C] [x^2] \text{ EXE}$                                                                                  |
| $-3^2 = -(3 \times 3) = -9$                                           | $(-) 3 [x^2] \text{ EXE}$                                                                                          |
| $\frac{1}{\frac{1}{3} - \frac{1}{4}} = 12$                            | $[C] 3 \text{SHIFT } [1/x] (x^{-1}) = 4 \text{SHIFT } [1/x] (x^{-1}) [C] \text{SHIFT } [1/x] (x^{-1}) \text{ EXE}$ |
| $8! (= 1 \times 2 \times 3 \times \dots \times 8) = 40320$            | $8 \text{OPTN } [F6] (\triangleright) [F1] (\text{PROB}) [1] (x!) \text{ EXE}$                                     |
| $\sqrt[3]{36 \times 42 \times 49} = 42$                               | $\text{SHIFT } [C] (\sqrt[3]{\phantom{x}}) [C] 36 \times 42 \times 49 [C] \text{ EXE}$                             |
| What is the absolute value of the common logarithm of $\frac{3}{4}$ ? |                                                                                                                    |
| $ \log \frac{3}{4}  = 0.1249387366$                                   | $\text{OPTN } [F5] (\text{NUM}) [1] (\text{Abs}) \log [C] 3 \div 4 [C] \text{ EXE}$                                |
| What is the integer part of $-3.5$ ? $-3$                             | $\text{OPTN } [F5] (\text{NUM}) [2] (\text{Int}) (-) 3.5 \text{ EXE}$                                              |
| What is the decimal part of $-3.5$ ? $-0.5$                           | $\text{OPTN } [F5] (\text{NUM}) [3] (\text{Frac}) (-) 3.5 \text{ EXE}$                                             |
| What is the nearest integer not exceeding $-3.5$ ? $-4$               | $\text{OPTN } [F5] (\text{NUM}) [5] (\text{Intg}) (-) 3.5 \text{ EXE}$                                             |



## ■ Random Number Generation (Ran#)

This function generates a 10-digit truly random or sequentially random number that is greater than zero and less than 1.

- A truly random number is generated if you do not specify anything for the argument.

| Example                                                                                             | Operation                                                                                                              |
|-----------------------------------------------------------------------------------------------------|------------------------------------------------------------------------------------------------------------------------|
| Ran # (Generates a random number.)<br><br>(Each press of <b>EXE</b> generates a new random number.) | <b>OPTN</b> <b>F6</b> ( $\triangleright$ ) <b>F1</b> (PROB) <b>4</b> (Ran#) <b>EXE</b><br><br><b>EXE</b><br><b>EXE</b> |

- Specifying an argument from 1 to 9 generates random numbers based on that sequence.
- Specifying an argument of 0 initializes the sequence.\*1

| Example                                                                                                          | Operation                                                          |
|------------------------------------------------------------------------------------------------------------------|--------------------------------------------------------------------|
| Ran# 1 (Generates the first random number in sequence 1.)<br>(Generates the second random number in sequence 1.) | <b>F1</b> (PROB) <b>4</b> (Ran#) <b>1</b> <b>EXE</b><br><b>EXE</b> |
| Ran# 0 (Initializes the sequence.)                                                                               | <b>F1</b> (PROB) <b>4</b> (Ran#) <b>0</b> <b>EXE</b>               |
| Ran# 1 (Generates the first random number in sequence 1.)                                                        | <b>F1</b> (PROB) <b>4</b> (Ran#) <b>1</b> <b>EXE</b>               |



\*1 Changing to a different sequence or generating a totally random number (without an argument) initializes the sequence.

## Coordinate Conversion

### Rectangular Coordinates

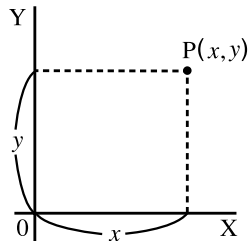

Pol  
←  
Rec

### Polar Coordinates

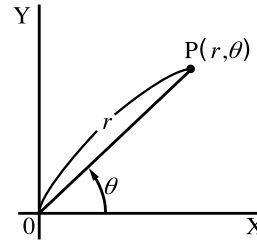

- With polar coordinates,  $\theta$  can be calculated and displayed within a range of  $-180^\circ < \theta \leq 180^\circ$  (radians and grads have same range).
- Be sure to specify Comp for Mode in the SET UP screen.

| Example                                                                                                                                        | Operation                                                                                                                                                                                             |
|------------------------------------------------------------------------------------------------------------------------------------------------|-------------------------------------------------------------------------------------------------------------------------------------------------------------------------------------------------------|
| Calculate $r$ and $\theta^\circ$ when $x = 14$ and $y = 20.7$<br>1 [ 24.989 ] → 24.98979792 ( $r$ )<br>2 [ 55.928 ] → 55.92839019 ( $\theta$ ) | $\text{CTRL}$ $\text{F3}$ (SET UP) $\text{F1}$ (Deg) $\text{ESC}$<br>$\text{OPTN}$ $\text{F6}$ ( $\triangleright$ ) $\text{F3}$ (ANGL) $\text{6}$ (Pol)<br>14 $\text{,}$ 20.7 $\text{)}$ $\text{EXE}$ |
| Calculate $x$ and $y$ when $r = 25$ and $\theta = 56^\circ$<br>1 [ 13.979 ] → 13.97982259 ( $x$ )<br>2 [ 20.725 ] → 20.72593931 ( $y$ )        | $\text{CTRL}$ $\text{F3}$ (SET UP) $\text{F1}$ (Deg) $\text{ESC}$<br>$\text{OPTN}$ $\text{F6}$ ( $\triangleright$ ) $\text{F3}$ (ANGL) $\text{7}$ (Rec)<br>25 $\text{,}$ 56 $\text{)}$ $\text{EXE}$   |



## ■ Permutation and Combination

- **Permutation**

$${}^n P_r = \frac{n!}{(n-r)!}$$

- **Combination**

$${}^n C_r = \frac{n!}{r!(n-r)!}$$

- Be sure to specify Comp for Mode in the SET UP screen.

● ● ● ● ●

**Example** To calculate the possible number of different arrangements using 4 items selected from among 10 items

| Formula             | Operation                                                                                                                                 |
|---------------------|-------------------------------------------------------------------------------------------------------------------------------------------|
| ${}_{10}P_4 = 5040$ | <b>10</b> <b>[OPTN]</b> <b>[F6]</b> <b>(▷)</b> <b>[F1]</b> <b>(PROB)</b> <b>[2]</b> <b>(<math>{}_nP_r</math>)</b> <b>[4]</b> <b>[EXE]</b> |

● ● ● ● ●

**Example** To calculate the possible number of different combinations of 4 items that can be selected from among 10 items

| Formula            | Operation                                                                                                                                 |
|--------------------|-------------------------------------------------------------------------------------------------------------------------------------------|
| ${}_{10}C_4 = 210$ | <b>10</b> <b>[OPTN]</b> <b>[F6]</b> <b>(▷)</b> <b>[F1]</b> <b>(PROB)</b> <b>[3]</b> <b>(<math>{}_nC_r</math>)</b> <b>[4]</b> <b>[EXE]</b> |



## Fractions

- Fractional values are displayed with the integer first, followed by the numerator and then the denominator.
- Be sure to specify Comp for Mode in the SET UP screen.

| Example                                                                                                                | Operation                                                                                                                                                                                                                                                |
|------------------------------------------------------------------------------------------------------------------------|----------------------------------------------------------------------------------------------------------------------------------------------------------------------------------------------------------------------------------------------------------|
| $\frac{2}{5} + 3\frac{1}{4} = 3\frac{13}{20}$ (Display: 3┆13┆20)<br>$= 3.65$                                           | $2 \left[ \frac{a}{b} \right] 5 \left[ + \right] 3 \left[ \frac{a}{b} \right] 1 \left[ \frac{a}{b} \right] 4 \left[ \text{EXE} \right]$<br>$\left[ \frac{a}{b} \right]$ (Conversion to decimal)<br>$\left[ \frac{a}{b} \right]$ (Conversion to fraction) |
| $\frac{1}{2578} + \frac{1}{4572} = 6.066202547 \times 10^{-4}$ (Display: 6.066202547E-04*1)<br>(Norm 1 display format) | $1 \left[ \frac{a}{b} \right] 2578 \left[ + \right] 1 \left[ \frac{a}{b} \right] 4572 \left[ \text{EXE} \right]$                                                                                                                                         |
| $\frac{1}{2} \times 0.5 = 0.25^{*2}$<br>$= \frac{1}{4}$                                                                | $1 \left[ \frac{a}{b} \right] 2 \left[ \times \right] .5 \left[ \text{EXE} \right]$<br>$\left[ \frac{a}{b} \right]$                                                                                                                                      |
| $1.5 + 2.3i = 1\frac{1}{2} + 2\frac{3}{10}i$ (Display: 1┆1┆2<br>+2┆3┆10i)                                              | $1.5 \left[ + \right] 2.3 \left[ \text{SHIFT} \right] \left[ 0 \right] \left[ i \right] \left[ \text{EXE} \right]$<br>$\left[ \frac{a}{b} \right] \left[ \frac{a}{b} \right]^{*3}$                                                                       |
| $\frac{1}{\frac{1}{3} + \frac{1}{4}} = 1\frac{5}{7}$ (Display: 1┆5┆7)                                                  | $1 \left[ \frac{a}{b} \right] \left[ ( \right] 1 \left[ \frac{a}{b} \right] 3 \left[ + \right] 1 \left[ \frac{a}{b} \right] 4 \left[ ) \right] \left[ \text{EXE} \right]^{*4}$                                                                           |



\*1 When the total number of characters, including integer, numerator, denominator and delimiter marks exceeds 10, the input fraction is automatically displayed in decimal format.

\*2 Calculations containing both fractions and decimals are calculated in decimal format.

\*3 Pressing  $\left[ \frac{a}{b} \right]$  once when converting the decimal part of a complex number to a fraction first displays the real part and imaginary part on separate lines.

\*4 You can include fractions within the numerator or denominator of a fraction by putting the numerator or denominator in parentheses.



## ■ Engineering Notation Calculations

Input engineering symbols using the engineering notation menu.

- Be sure to specify Comp for Mode in the SET UP screen.

| Example                                                                                                       | Operation                                                                                                                                                                                                                                                                              |
|---------------------------------------------------------------------------------------------------------------|----------------------------------------------------------------------------------------------------------------------------------------------------------------------------------------------------------------------------------------------------------------------------------------|
| $999\text{k (kilo)} + 25\text{k (kilo)}$<br>$= 1.024\text{M (mega)}$                                          | $\text{CTRL [F3] (SET UP) } \downarrow \downarrow \downarrow \downarrow \downarrow \downarrow \downarrow \downarrow \downarrow \downarrow$<br>$\text{[F4] (Eng) [ESC]}$<br>$999 \text{ [OPTN] [F5] (NUM) [6] (E-SYM) [6] (k) [+ 25] [F5] (NUM)}$<br>$\text{[6] (E-SYM) [6] (k) [EXE]}$ |
| $9 \div 10 = 0.9 = 900\text{m (milli)}$<br>$= 0.9$<br>$= 0.0009\text{k (kilo)}$<br>$= 0.9$<br>$= 900\text{m}$ | $9 \text{ [OPTN] [F6] (DIV) 10 [EXE]}$<br>$\text{[OPTN] [F6] (▷) [F6] (▷) [F6] (▷) [F3] (←ENG)*1}$<br>$\text{[F3] (←ENG)*1}$<br>$\text{[F2] (ENG)*2}$<br>$\text{[F2] (ENG)*2}$                                                                                                         |



\*1 Converts the displayed value to the next higher engineering unit, by shifting the decimal point three places to the right.

\*2 Converts the displayed value to the next lower engineering unit, by shifting the decimal point three places to the left.

## 2-5 Numerical Calculations

The following describes the items that are available in the menu you use when performing differential/ quadratic differential, integration,  $\Sigma$ , maximum/minimum value, and Solve calculations.

When the option menu is on the display, press **F4** (CALC) to display the function analysis menu. The items of this menu are used when performing specific types of calculations.

- $\{d/dx\}/\{d^2/dx^2\}/\{dx\}/\{\Sigma\}/\{\mathbf{FMin}\}/\{\mathbf{FMax}\}/\{\mathbf{Solve}\}$  ... {differential}/ {quadratic differential}/ {integration}/ { $\Sigma$  (sigma)}/ {minimum value}/ {maximum value}/ {solve} calculations

### Solve calculations

The following is the syntax for using the Solve function in a program.

Solve(  $f(x)$ ,  $n$ ,  $a$ ,  $b$  )      ( $a$ : lower limit,  $b$ : upper limit,  $n$ : initial estimated value)

- There are two different input methods that can be used for Solve calculations: direct assignment and variable table input.

With the direct assignment method (the one described here), you assign values directly to variables. This type of input is identical to that used with the Solve command used in the PRGM Mode.

Variable table input is used with the Solve function in the EQUA Mode. This input method is recommend for most normal Solve function input.

An Error (Iteration ERROR) occurs when there is no convergence of the solution.





## ■ Differential Calculations

[OPTN]-[CALC]-[d/dx]



To perform differential calculations, first display the function analysis menu, and then input the values shown in the formula below.

[OPTN] [F4] (CALC) [1] (d/dx) f(x) [◀] a [▶] tol [◻]

(a: point for which you want to determine the derivative, tol: tolerance)

$$d/dx (f(x), a) \Rightarrow \frac{d}{dx} f(a)$$

The differentiation for this type of calculation is defined as:

$$f'(a) = \lim_{\Delta x \rightarrow 0} \frac{f(a + \Delta x) - f(a)}{\Delta x}$$

In this definition, *infinitesimal* is replaced by a *sufficiently small*  $\Delta x$ , with the value in the neighborhood of  $f'(a)$  calculated as:

$$f'(a) \approx \frac{f(a + \Delta x) - f(a)}{\Delta x}$$

In order to provide the best precision possible, this unit employs central difference to perform differential calculations.

### Using Differential Calculation in a Graph Function

- Omitting the tolerance (*tol*) value when using the differential command inside of a graph function simplifies the calculation for drawing the graph. In such a case, precision is sacrificed for the sake of faster drawing. The tolerance value is specified, the graph is drawn with the same precision obtained when you normally perform a differential calculation.
- You can also omit input of the derivative point by using the following format for the differential graph:  $Y2=d/dx(Y1)$ . In this case, the value of the X variable is used as the derivative point.



**Example** To determine the derivative at point  $x = 3$  for the function  $y = x^3 + 4x^2 + x - 6$ , with a tolerance of “tol” =  $1E-5$

Input the function  $f(x)$ .

**AC** **OPTN** **F4** (CALC) **1** (d/dx) **X,θ,T** **^** **3** **+** **4** **X,θ,T** **x<sup>2</sup>** **+** **X,θ,T** **-** **6** **,**

Input point  $x = a$  for which you want to determine the derivative.

**3** **,**

Input the tolerance value.

**1** **EXP** **(-)** **5** **)**

**EXE**

```
d/dx(X^3+4X^2+X-6,3,1E-5)
52
```



# In the function  $f(x)$ , only  $X$  can be used as a variable in expressions. Other variables (A through Z,  $r$ ,  $\theta$ ) are treated as constants, and the value currently assigned to that variable is applied during the calculation.

# Input of the tolerance ( $tol$ ) value and the closing parenthesis can be omitted. If you omit tolerance ( $tol$ ) value, the calculator automatically uses a value for  $tol$  as  $1E-10$ .

# Specify tolerance ( $tol$ ) value of  $1E-14$  or less. An error (Iteration ERROR) occurs whenever no solution that satisfies the tolerance value can be obtained.

# Discontinuous points or sections with drastic fluctuation can adversely affect precision or even cause an error.



### • Applications of Differential Calculations

- Differentials can be added, subtracted, multiplied and divided with each other.

$$\frac{d}{dx} f(a) = f'(a), \frac{d}{dx} g(a) = g'(a)$$

Therefore:

$$f'(a) + g'(a), f'(a) \times g'(a), \text{ etc.}$$

- Differential results can be used in addition, subtraction, multiplication, and division, and in functions.

$$2 \times f'(a), \log (f'(a)), \text{ etc.}$$

- Functions can be used in any of the terms ( $f(x)$ ,  $a$ ,  $tol$ ) of a differential.

$$\frac{d}{dx} (\sin x + \cos x, \sin 0.5, 1E - 8), \text{ etc.}$$



# You cannot use a differential, quadratic differential, integration,  $\Sigma$ , maximum/minimum value or solve calculation expression inside a differential calculation term.

# Pressing **AC** during calculation of a differential (while the cursor is not shown on the display) interrupts the calculation.

# Always use radians (Rad Mode) as the angle unit when performing trigonometric differentials.

## ■ Quadratic Differential Calculations

[OPTN]-[CALC]-[d<sup>2</sup>/dx<sup>2</sup>]



After displaying the function analysis menu, you can input quadratic differentials using either of the two following formats.

$$\boxed{\text{OPTN}} \boxed{\text{F4}} \boxed{\text{(CALC)}} \boxed{2} \boxed{(d^2/dx^2)} \boxed{f(x)} \boxed{,} \boxed{a} \boxed{,} \boxed{tol} \boxed{)}$$

(*a*: differential coefficient point, *tol*: tolerance)

$$\frac{d^2}{dx^2} (f(x), a) \Rightarrow \frac{d^2}{dx^2} f(a)$$

Quadratic differential calculations produce an approximate differential value using the following second order differential formula, which is based on Newton's polynomial interpretation.

$$f''(a) = \frac{2f(a+3h) - 27f(a+2h) + 270f(a+h) - 490f(a) + 270f(a-h) - 27f(a-2h) + 2f(a-3h)}{180h^2}$$

In this expression, values for “sufficiently small increments of *h*” are used to obtain a value that approximates *f''*(*a*).



**Example** To determine the quadratic differential coefficient at the point where  $x = 3$  for the function  $y = x^3 + 4x^2 + x - 6$   
Here we will use a tolerance  $tol = 1E - 5$

Input the function *f*(*x*).

$$\boxed{\text{AC}} \boxed{\text{OPTN}} \boxed{\text{F4}} \boxed{\text{(CALC)}} \boxed{2} \boxed{(d^2/dx^2)} \boxed{\text{X,θ,T}} \boxed{\wedge} \boxed{3} \boxed{+}$$

$$\boxed{4} \boxed{\text{X,θ,T}} \boxed{x^2} \boxed{+} \boxed{\text{X,θ,T}} \boxed{-} \boxed{6} \boxed{,}$$

Input 3 as point *a*, which is differential coefficient point.

$$\boxed{3} \boxed{,}$$

Input the tolerance value.

$$\boxed{1} \boxed{\text{EXP}} \boxed{(-)} \boxed{5} \boxed{)}$$

$$\boxed{\text{EXE}}$$

$$\boxed{\frac{d^2}{dx^2}(X^3+4X^2+X-6, 3, 1E-5)} \quad 26$$



# In the function *f*(*x*), only X can be used as a variable in expressions. Other variables (A through Z, *r*, *θ*) are treated as constants, and the value currently assigned to that variable is applied during the calculation.

# Input of the tolerance (*tol*) value and the closing parenthesis can be omitted.  
# Discontinuous points or sections with drastic fluctuation can adversely affect precision or even cause an error.



## • Quadratic Differential Applications

- Arithmetic operations can be performed using two quadratic differentials.

$$\frac{d^2}{dx^2} f(a) = f''(a), \quad \frac{d^2}{dx^2} g(a) = g''(a)$$

Therefore:

$$f''(a) + g''(a), f''(a) \times g''(a), \text{ etc.}$$

- The result of a quadratic differential calculation can be used in a subsequent arithmetic or function calculation.

$$2 \times f''(a), \log(f''(a)), \text{ etc.}$$

- Functions can be used within the terms  $(f(x), a, tol)$  of a quadratic differential expression.

$$\frac{d^2}{dx^2} (\sin x + \cos x, \sin 0.5, 1E-8), \text{ etc.}$$



# You cannot use a differential, quadratic differential, integration,  $\Sigma$ , maximum/minimum value or Solve calculation expression inside of a quadratic differential calculation term.

# Specify tolerance (*tol*) value of 1E-14 or less. An error (Iteration ERROR) occurs whenever no solution that satisfies the tolerance value can be obtained.

# You can interrupt an ongoing quadratic differential calculation by pressing the  $\square$  key.

# Always use radians (Rad Mode) as the angle unit when performing trigonometric quadratic differentials.

# Using Quadratic Differential Calculation in a Graph Function (see page 2-5-2)

## Integration Calculations

[OPTN]-[CALC]-[f dx]



To perform integration calculations, first display the function analysis menu and then input the values in the formula shown below.

[OPTN] [F4] (CALC) [3] (f dx) f(x) [ ] a [ ] b [ ] tol [ ]

(a: start point, b: end point, tol: tolerance)

$$\int(f(x), a, b, tol) \Rightarrow \int_a^b f(x) dx$$

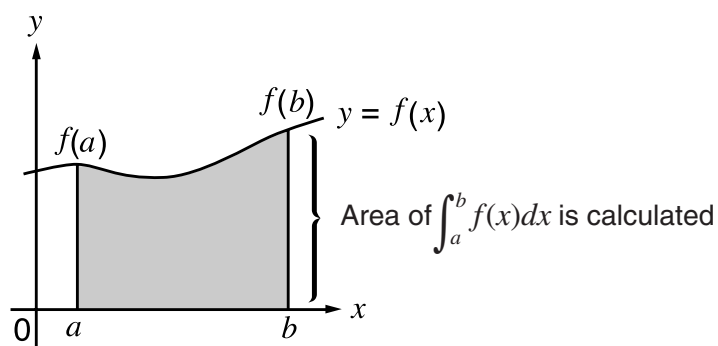

As shown in the illustration above, integration calculations are performed by calculating integral values from  $a$  through  $b$  for the function  $y = f(x)$  where  $a \leq x \leq b$ , and  $f(x) \geq 0$ . This in effect calculates the surface area of the shaded area in the illustration.



# If  $f(x) < 0$  where  $a \leq x \leq b$ , the surface area calculation produces negative values (surface area  $\times -1$ ).



**Example** To perform the integration calculation for the function shown below, with a tolerance of “tol” =  $1\text{E}-4$

$$\int_1^5 (2x^2 + 3x + 4) dx$$

Input the function  $f(x)$ .

**AC** **OPTN** **F4** (CALC) **3** ( $\int dx$ ) **2** **X,θ,T** **x<sup>2</sup>** **+** **3** **X,θ,T** **+** **4** **▸**

Input the start point and end point.

**1** **▸** **5** **▸**

Input the tolerance value.

**1** **EXP** **(-)** **4** **)**  
**EXE**

$\int(2X^2+3X+4,1,5,1E-4)$   
134.6666667

## • Application of Integration Calculation

- Integrals can be used in addition, subtraction, multiplication and division.

$$\int_a^b f(x) dx + \int_c^d g(x) dx, \text{ etc.}$$

- Integration results can be used in addition, subtraction, multiplication and division, in functions.

$$2 \times \int_a^b f(x) dx, \text{ etc. } \log \left( \int_a^b f(x) dx \right), \text{ etc.}$$

- Functions can be used in any of the terms ( $f(x)$ ,  $a$ ,  $b$ ,  $tol$ ) of an integral.

$$\int_{\sin 0.5}^{\cos 0.5} (\sin x + \cos x) dx = \int(\sin x + \cos x, \sin 0.5, \cos 0.5, 1\text{E}-4)$$



# In the function  $f(x)$ , only X can be used as a variable in expressions. Other variables (A through Z,  $r$ ,  $\theta$ ) are treated as constants, and the value currently assigned to that variable is applied during the calculation.

# Input of “tol” and closing parenthesis can be omitted. If you omit “tol,” the calculator automatically uses a default value of  $1\text{E}-5$ .

# Integration calculations can take a long time to complete.

# You cannot use a differential, quadratic differential, integration,  $\Sigma$ , maximum/minimum value or Solve calculation expression inside of an integration calculation term.



Note the following points to ensure correct integration values.

- (1) When cyclical functions for integration values become positive or negative for different divisions, perform the calculation for single cycles, or divide between negative and positive, and then add the results together.

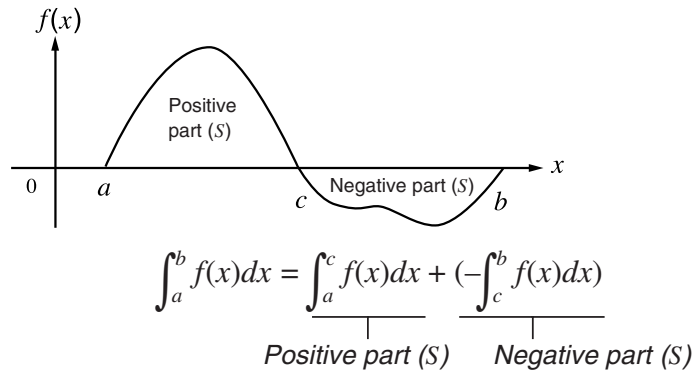

- (2) When minute fluctuations in integration divisions produce large fluctuations in integration values, calculate the integration divisions separately (divide the large fluctuation areas into smaller divisions), and then add the results together.

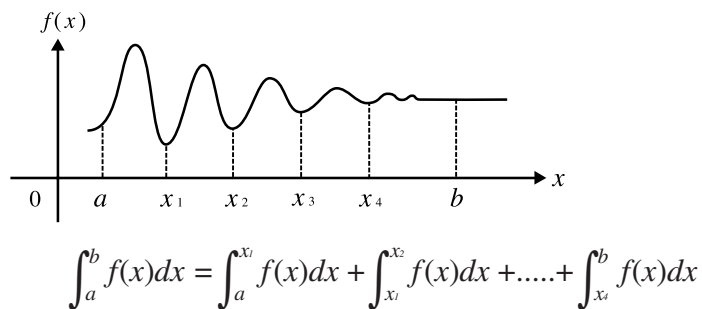

# Pressing **AC** during calculation of an integral (while the cursor is not shown on the display) interrupts the calculation.

# Always use radians (Rad Mode) as the angle unit when performing trigonometric integrations.

# An error (Iteration ERROR) occurs whenever no solution that satisfies the tolerance value can be obtained.



## ■ $\Sigma$ Calculations

[OPTN]-[CALC]-[ $\Sigma$ ]



To perform  $\Sigma$  calculations, first display the function analysis menu, and then input the values shown in the formula below.

[OPTN] [F4] (CALC) [4] ( $\Sigma$ )  $a_k$  [ ]  $k$  [ ]  $\alpha$  [ ]  $\beta$  [ ]  $n$  [ ]

$$\Sigma (a_k, k, \alpha, \beta, n) = \sum_{k=\alpha}^{\beta} a_k = a_{\alpha} + a_{\alpha+1} + \dots + a_{\beta}$$

( $n$ : distance between partitions)



**Example** To calculate the following:

$$\sum_{k=2}^6 (k^2 - 3k + 5)$$

Use  $n = 1$  as the distance between partitions.

[AC] [OPTN] [F4] (CALC) [4] ( $\Sigma$ ) [ALPHA] [ ] (K) [x<sup>2</sup>]  
 [ ] [3] [ALPHA] [ ] (K) [+ ] [5] [ ]  
 [ALPHA] [ ] (K) [ ] [2] [ ] [6] [ ] [1] [ ] [ ] [EXE]

$\Sigma(K^2-3K+5,K,2,6,1)$  55



# You can use only one variable in the function for input sequence  $a_k$ .  
 # Input integers only for the initial term ( $\alpha$ ) of sequence  $a_k$  and last term ( $\beta$ ) of sequence  $a_k$ .

# Input of  $n$  and the closing parentheses can be omitted. If you omit  $n$ , the calculator automatically uses  $n = 1$ .



## • $\Sigma$ Calculation Applications

- Arithmetic operations using  $\Sigma$  calculation expressions

Expressions:  $S_n = \sum_{k=1}^n a_k, T_n = \sum_{k=1}^n b_k$

Possible operations:  $S_n + T_n, S_n - T_n, \text{ etc.}$

- Arithmetic and function operations using  $\Sigma$  calculation results

$2 \times S_n, \log(S_n), \text{ etc.}$

- Function operations using  $\Sigma$  calculation terms  $(a_k, k)$

$\Sigma(\sin k, k, 1, 5), \text{ etc.}$



# You cannot use a differential, quadratic differential, integration,  $\Sigma$ , maximum/minimum value or Solve calculation expression inside of a  $\Sigma$  calculation term.

# Make sure that the value used as the final term  $\beta$  is greater than the value used as the initial term  $\alpha$ . Otherwise, an error will occur.

# To interrupt an ongoing  $\Sigma$  calculation (indicated when the cursor is not on the display), press the **AC** key.

## Maximum/Minimum Value Calculations

[OPTN]-[CALC]-[FMin]/[FMax]



After displaying the function analysis menu, you can input maximum/minimum calculations using the formats below, and solve for the maximum and minimum of a function within interval  $a \leq x \leq b$ . ( $a$ : start point of interval,  $b$ : end point of interval,  $n$ : precision ( $n = 1$  to  $9$ ))

### •Minimum Value

[OPTN] [F4] (CALC) [5] (FMin)  $f(x)$  [ ]  $a$  [ ]  $b$  [ ]  $n$  [ ]

### •Maximum Value

[OPTN] [F4] (CALC) [6] (FMax)  $f(x)$  [ ]  $a$  [ ]  $b$  [ ]  $n$  [ ]

• • • • •

**Example 1** To determine the minimum value for the interval defined by start point  $a = 0$  and end point  $b = 3$ , with a precision of  $n = 6$  for the function  $y = x^2 - 4x + 9$

Input  $f(x)$ .

[AC] [OPTN] [F4] (CALC) [5] (FMin) [X,θ,T]  $x^2$  [-] [4] [X,θ,T] [+] [9] [ ]

Input the interval  $a = 0$ ,  $b = 3$ .

[0] [ ] [3] [ ]

Input the precision  $n = 6$ .

[6] [ ]

[EXE]

|             |
|-------------|
| Ans         |
| 1 [ ] 2 [ ] |
| 2 [ ] 5 [ ] |



**Example 2** To determine the maximum value for the interval defined by start point  $a = 0$  and end point  $b = 3$ , with a precision of  $n = 6$  for the function  $y = -x^2 + 2x + 2$

Input  $f(x)$ .

**AC** **OPTN** **F4** (CALC) **6** (FMax) **(←)** **X,θ,T** **x<sup>2</sup>** **+** **2** **X,θ,T** **+** **2** **,**

Input the interval  $a = 0$ ,  $b = 3$ .

**0** **,** **3** **,**

Input the precision  $n = 6$ .

**6** **)**

**EXE**



- # In the function  $f(x)$ , only X can be used as a variable in expressions. Other variables (A through Z,  $r$ ,  $\theta$ ) are treated as constants, and the value currently assigned to that variable is applied during the calculation.
- # Input of  $n$  and the closing parenthesis can be omitted.
- # Discontinuous points or sections with drastic fluctuation can adversely affect precision or even cause an error.
- # You cannot use a differential, quadratic differential, integration,  $\Sigma$ , maximum/minimum value or Solve calculation expression inside of a maximum/minimum calculation term.

- # Inputting a larger value for  $n$  increases the precision of the calculation, but it also increases the amount of time required to perform the calculation.
- # The value you input for the end point of the interval ( $b$ ) must be greater than the value you input for the start point ( $a$ ). Otherwise an error occurs.
- # You can interrupt an ongoing maximum/minimum calculation by pressing the **AC** key.
- # You can input an integer in the range of 1 to 9 for the value of  $n$ . Using any value outside this range causes an error.

## 2-6 Complex Number Calculations

You can perform addition, subtraction, multiplication, division, parentheses calculations, function calculations, and memory calculations with complex numbers just as you do with the manual calculations described on pages 2-1-1 and 2-4-6.

You can select the complex number calculation mode by changing the Complex Mode item on the SET UP screen to one of the following settings.

- **{Real}** ... Calculation in the real number range only\*<sup>1</sup>
- **{a+bi}** ... Performs complex number calculation and displays results in rectangular coordinate format
- **{re<sup>θ</sup>i}** ... Performs complex number calculation and displays results in polar coordinate format\*<sup>2</sup>

Press **[OPTN]** **[F3]** (CPLX) to display the complex calculation number menu, which contains the following items.

- **{Abs}/{Arg}** ... obtains {absolute value}/{argument}
- **{Conjg}** ... {obtains conjugate}
- **{ReP}/{ImP}** ... {real number}/{imaginary number} part extraction
- **{►re<sup>θ</sup>i}/{►a+bi}** ... converts the result to {polar}/{linear}



\*<sup>1</sup> When there is an imaginary number in the argument, however, complex number calculation is performed and the result is displayed using rectangular coordinate format.

Examples:

$$\ln 2i = 0.6931471806 + 1.570796327i$$

$$\ln 2i + \ln (-2) = (\text{Non-Real ERROR})$$

\*<sup>2</sup> The display range of  $\theta$  depends on the angle unit set for the Angle item on the SET UP screen.

- Deg ...  $-180 < \theta \leq 180$
- Rad ...  $-\pi < \theta \leq \pi$
- Gra ...  $-200 < \theta \leq 200$

# Solutions obtained by the Real and  $a+bi / re^{\theta}i$  modes are different for power root ( $x^y$ ) calculations when  $x < 0$  and  $y = m/n$  when  $n$  is an odd number.

Example:

$$3^{\sqrt{-8}} = -2 \text{ (Real)}$$

$$= 1 + 1.732050808i(a+bi / re^{\theta}i)$$



## ■ Absolute Value and Argument

[OPTN]-[CPLX]-[Abs]/[Arg]

The unit regards a complex number in the format  $Z = a + bi$  as a coordinate on a Gaussian plane, and calculates absolute value  $|Z|$  and argument (arg).



**Example** To calculate absolute value ( $r$ ) and argument ( $\theta$ ) for the complex number  $3 + 4i$ , with the angle unit set for degrees

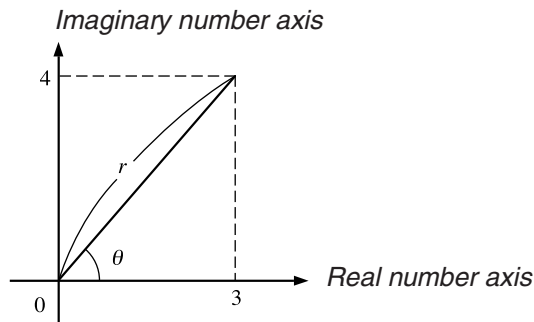

[AC] [OPTN] [F3] (CPLX) [1] (Abs)

[<] [3] [+ ] [4] [SHIFT] [0] (i) [>] [EXE]

(Calculation of absolute value)

Abs (3+4i) 5

[AC] [OPTN] [F3] (CPLX) [2] (Arg)

[<] [3] [+ ] [4] [SHIFT] [0] (i) [>] [EXE]

(Calculation of argument)

Arg (3+4i) 53.13010235



# The result of the argument calculation differs in accordance with the current angle unit setting (degrees, radians, grads).

## ■ Conjugate Complex Numbers

[OPTN]-[CPLX]-[Conjg]

A complex number of the format  $a + bi$  becomes a conjugate complex number of the format  $a - bi$ .

● ● ● ● ●

**Example** To calculate the conjugate complex number for the complex number  $2 + 4i$

AC OPTN F3 (CPLX) 3 (Conjg)  
 ( 2 + 4 SHIFT 0 (i) ) EXE

Conjg (2+4i) 2-4i

## ■ Extraction of Real and Imaginary Number Parts [OPTN]-[CPLX]-[ReP]/[ImP]

Use the following procedure to extract real part  $a$  and imaginary part  $b$  from a complex number with the format  $a + bi$ .

● ● ● ● ●

**Example** To extract the real and imaginary parts of the complex number  $2 + 5i$

AC OPTN F3 (CPLX) 4 (ReP)  
 ( 2 + 5 SHIFT 0 (i) ) EXE

ReP (2+5i) 2

(Real part extraction)

AC OPTN F3 (CPLX) 5 (ImP)  
 ( 2 + 5 SHIFT 0 (i) ) EXE

ImP (2+5i) 5

(Imaginary part extraction)



# The input/output range of complex numbers is normally 10 digits for the mantissa and two digits for the exponent.

# When a complex number has more than 21 digits, the real number part and imaginary number part are displayed on separate lines.

# When either the real number part or imaginary number part of a complex number equals zero, that part is not displayed in rectangular form.

# 18 bytes of memory are used whenever you assign a complex number to a variable.

# The following functions can be used with complex numbers.

$\sqrt{\quad}$ ,  $x^2$ ,  $x^{-1}$ ,  $\wedge(x^y)$ ,  $\sqrt[3]{\quad}$ ,  $\sqrt[x]{\quad}$ ,  $\ln$ ,  $\log$ ,  $10^x$ ,  $e^x$ ,  $\sin$ ,  $\cos$ ,  $\tan$ ,  $\sin^{-1}$ ,  $\cos^{-1}$ ,  $\tan^{-1}$ ,  $\sinh$ ,  $\cosh$ ,  $\tanh$ ,  $\sinh^{-1}$ ,  $\cosh^{-1}$ ,  $\tanh^{-1}$

Int, Frac, Rnd, Intg, Fix, Sci, ENG,  $\leftarrow$ ENG,  $^\circ$  ' "

$\angle$  ' ' ",  $a^b/c$ ,  $d/c$

## ■ Polar Form and Rectangular Transformation

[OPTN]-[CPLX]-[►re<sup>θi</sup>]

Use the following procedure to transform a complex number displayed in rectangular form to polar form, and vice versa.

● ● ● ● ●

**Example** To transform the rectangular form of complex number  $1 + \sqrt{3}i$  to its polar form

|        |             |     |                          |       |         |                      |                          |
|--------|-------------|-----|--------------------------|-------|---------|----------------------|--------------------------|
| [AC]   | [1]         | [+] | [ $\sqrt{\phantom{x}}$ ] | [3]   | [ $i$ ] | [►re <sup>θi</sup> ] | 1+(√3)i►re <sup>θi</sup> |
| [OPTN] | [F3 (CPLX)] | [6] | [►re <sup>θi</sup> ]     | [EXE] |         |                      | 2e60i                    |



## 2-7 Binary, Octal, Decimal, and Hexadecimal Calculations



You can use the **RUN • MAT Mode** and binary, octal, decimal, and hexadecimal settings to perform calculations that involve binary, octal, decimal and hexadecimal values. You can also convert between number systems and perform logical operations.

- You cannot use scientific functions in binary, octal, decimal, and hexadecimal calculations.
- You can use only integers in binary, octal, decimal, and hexadecimal calculations, which means that fractional values are not allowed. If you input a value that includes a decimal part, the unit automatically cuts off the decimal part.
- If you attempt to enter a value that is invalid for the number system (binary, octal, decimal, hexadecimal) you are using, the calculator displays an error message. The following shows the numerals that can be used in each number system.

Binary: 0, 1

Octal: 0, 1, 2, 3, 4, 5, 6, 7

Decimal: 0, 1, 2, 3, 4, 5, 6, 7, 8, 9

Hexadecimal: 0, 1, 2, 3, 4, 5, 6, 7, 8, 9, A, B, C, D, E, F

- Negative binary, octal, and hexadecimal values are produced using the two's complement of the original value.
- The following are the display capacities for each of the number systems.

| Number System | Display Capacity |
|---------------|------------------|
| Binary        | 16 digits        |
| Octal         | 11 digits        |
| Decimal       | 10 digits        |
| Hexadecimal   | 8 digits         |



# The alphabetic characters used in the hexadecimal number appear differently on the display to distinguish them from text characters.

Normal Text: A, B, C, D, E, F

Hexadecimal Values: **/A**, **/B**, **/C**, **/D**, **/E**, **/F**

- The following are the calculation ranges for each of the number systems.

#### Binary Values

Positive:  $0 \leq x \leq 1111111111111111$

Negative:  $1000000000000000 \leq x \leq 1111111111111111$

#### Octal Values

Positive:  $0 \leq x \leq 17777777777$

Negative:  $20000000000 \leq x \leq 37777777777$

#### Decimal Values

Positive:  $0 \leq x \leq 2147483647$

Negative:  $-2147483648 \leq x \leq -1$

#### Hexadecimal Values

Positive:  $0 \leq x \leq 7FFFFFFF$

Negative:  $80000000 \leq x \leq FFFFFFFF$

---

### • To perform a binary, octal, decimal, or hexadecimal calculation

[SET UP]- [Mode]- [Dec]/[Hex]/[Bin]/[Oct]

1. In the main menu, select **RUN • MAT**.
2. Press **CTRL F3** (SET UP) and then specify the default number system by pressing **F2** (Dec), **F3** (Hex), **F4** (Bin), or **F5** (Oct).
3. Press **ESC** to change to the screen for calculation input. This causes a function menu with the following items to appear.
  - {d~o}/ {LOGIC}/ {DISP}/ {SYBL} ... {number system specification}/ {logical operation}/ {decimal/hexadecimal/binary/octal conversion}/ {symbol} menu



## ■ Selecting a Number System

You can specify decimal, hexadecimal, binary, or octal as the default number system using the set up screen. After you press the function key that corresponds to the system you want to use, press **EXE**.

### ● To specify a number system for an input value

You can specify a number system for each individual value you input. Press **F1**(d~o) to display a menu of number system symbols. Press the function key that corresponds to the symbol you want to select and then input the value.

- **{d}/{h}/{b}/{o} ... {decimal}/{hexadecimal}/{binary}/{octal}**

### ● To input values of mixed number systems

● ● ● ● ●

**Example** To input  $123_{10}$  or  $1010_2$ , when the default number system is hexadecimal

|                                                                              |       |          |
|------------------------------------------------------------------------------|-------|----------|
| <b>CTRL</b> <b>F3</b> (SET UP) <b>F3</b> (Hex) <b>ESC</b>                    | d123  | 0000007B |
| <b>AC</b> <b>F1</b> (d~o) <b>1</b> (d) <b>1</b> <b>2</b> <b>3</b> <b>EXE</b> |       |          |
| <b>F1</b> (d~o) <b>3</b> (b) <b>1</b> <b>0</b> <b>1</b> <b>0</b> <b>EXE</b>  | b1010 | 0000000A |

## ■ Arithmetic Operations

● ● ● ● ●

**Example 1** To calculate  $10111_2 + 11010_2$

|                                                                 |                  |
|-----------------------------------------------------------------|------------------|
| <b>CTRL</b> <b>F3</b> (SET UP) <b>F4</b> (Bin) <b>ESC</b>       | 10111+11010      |
| <b>AC</b> <b>1</b> <b>0</b> <b>1</b> <b>1</b> <b>1</b> <b>+</b> | 0000000000110001 |
| <b>1</b> <b>1</b> <b>0</b> <b>1</b> <b>0</b> <b>EXE</b>         |                  |

• • • • •

**Example 2** To input and execute  $123_8 \times ABC_{16}$ , when the default number system is decimal or hexadecimal

|                               |           |          |
|-------------------------------|-----------|----------|
| CTRL F3 (SET UP) F2 (Dec) ESC | o123xhABC | 228084   |
| AC F1 (d~o) 4 (o) 1 2 3 X     |           |          |
| F1 (d~o) 2 (h) A B C EXE      |           |          |
|                               |           |          |
| F3 (DISP) 2 (Hex) EXE         | Ans ▶ Hex | 00037AF4 |

## ■ Negative Values and Logical Operations

Press F2 (LOGIC) to display a menu of negation and logical operators.

- {Neg} ... {negation}
- {Not}/{and}/{or}/{xor}/{xnor} ... {NOT}/{AND}/{OR}/{XOR}/{XNOR}

### • Negative Values

• • • • •

**Example** To determine the negative of  $110010_2$

|                               |            |                  |
|-------------------------------|------------|------------------|
| CTRL F3 (SET UP) F4 (Bin) ESC | Neg 110010 | 1111111111001110 |
| AC F2 (LOGIC) 1 (Neg)         |            |                  |
| 1 1 0 0 1 0 EXE               |            |                  |

### • Logical Operations

• • • • •

**Example 1** To input and execute “ $120_{16}$  and  $AD_{16}$ ”

|                               |          |          |
|-------------------------------|----------|----------|
| CTRL F3 (SET UP) F3 (Hex) ESC | 120andAD | 00000020 |
| AC 1 2 0 F2 (LOGIC)           |          |          |
| 3 (and) A D EXE               |          |          |

• • • • •

**Example 2** To display the result of “36<sub>8</sub> or 1110<sub>2</sub>” as an octal value

CTRL F3 (SET UP) F5 (Oct) ESC

36orb1110 000000000036

AC 3 6 F2 (LOGIC)

4 (or) F1 (d~o) 3 (b)

1 1 1 0 EXE

• • • • •

**Example 3** To negate 2FFFED<sub>16</sub>

CTRL F3 (SET UP) F3 (Hex) ESC

Not 2FFFED FFD00012

AC F2 (LOGIC) 2 (Not)

2 F F F E D EXE

---

## • Number System Transformation

Press F3 (DISP) to display a menu of number system transformation functions.

- {►Dec}/{►Hex}/{►Bin}/{►Oct} ... transformation of displayed value to its {decimal}/{hexadecimal}/{binary}/{octal} equivalent

---

## • To convert a displayed value from one number system to another

• • • • •

**Example** To convert 22<sub>10</sub> (default number system) to its binary or octal value

AC CTRL F3 (SET UP) F2 (Dec) ESC

d22 22

F1 (d~o) 1 (d) 2 2 EXE

F3 (DISP) 3 (►Bin) EXE

0000000000010110

F3 (DISP) 4 (►Oct) EXE

000000000026



## 2-8 Matrix Calculations



From the Main Menu, enter the **RUN•MAT** Mode, and press **[F1]** (MAT) to perform Matrix calculations.

26 matrix memories (Mat A through Mat Z) plus a Matrix Answer Memory (MatAns), make it possible to perform the following matrix operations.

- Addition, subtraction, multiplication
- Scalar product calculations
- Determinant calculations
- Matrix transposition
- Matrix inversion
- Matrix squaring
- Raising a matrix to a specific power
- Absolute value, integer part extraction, fractional part extraction, maximum integer calculations
- Matrix modification using matrix commands
- Absolute value, argument, complex conjugate calculation for a matrix with complex number components
- Real number part and complex number part extraction of a matrix with complex number components

The maximum number of rows that can be specified for a matrix is 255, and the maximum number of columns is 255.



### # About Matrix Answer Memory (MatAns)

The calculator automatically stores matrix calculation results in Matrix Answer Memory. Note the following points about Matrix Answer Memory.

- Whenever you perform a matrix calculation, the current Matrix Answer Memory contents are replaced by the new result. The previous contents are deleted and cannot be recovered.
- Inputting values into a matrix does not affect Matrix Answer Memory contents.



## Inputting and Editing Matrices

Pressing **[F1]**(MAT) displays the matrix editor screen. Use the matrix editor to input and edit matrices.

| Matrix            |        |
|-------------------|--------|
| Mat A             | : 2x 2 |
| Mat B             | : None |
| Mat C             | : None |
| Mat D             | : None |
| Mat E             | : None |
| Mat F             | : None |
| DIM   DEL   DEL-A |        |

$m \times n$  ...  $m$  (row)  $\times$   $n$  (column) matrix

None... no matrix preset

- **{DIM}** ... {specifies the matrix dimensions (number of cells)}
- **{DEL}**/**{DEL-A}** ... deletes {a specific matrix}/{all matrices}

## Creating a Matrix

To create a matrix, you must first define its dimensions (size) in the Matrix list. Then you can input values into the matrix.

### To specify the dimensions (size) of a matrix



**Example** To create a 2-row  $\times$  3-column matrix in the area named Mat B

Highlight Mat B.



| Matrix |        |
|--------|--------|
| Mat A  | : 2x 2 |
| Mat B  | : None |

**[F1]** (DIM)

Specify the number of rows.

**[2]** **[EXE]**

Specify the number of columns.

**[3]** **[EXE]**

**[EXE]**

| Dimension m $\times$ n |     |
|------------------------|-----|
| m                      | : 2 |
| n                      | : 3 |

|   | 1 | 2 | 3 |
|---|---|---|---|
| 1 | 0 | 0 | 0 |
| 2 | 0 | 0 | 0 |



- All of the cells of a new matrix contain the value 0.

# If "Memory ERROR" remains next to the matrix area name after you input the dimensions, it

means there is not enough free memory to create the matrix you want.



• To input cell values



**Example** To input the following data into Matrix B :

$$\begin{bmatrix} 1 & 2 & 3 \\ 4 & 5 & 6 \end{bmatrix}$$

⏴ (Selects Mat B.)



EXE

1 EXE 2 EXE 3 EXE

4 EXE 5 EXE 6 EXE

(Data is input into the highlighted cell.  
Each time you press **EXE**, the highlighting  
move to the next cell to the right.)

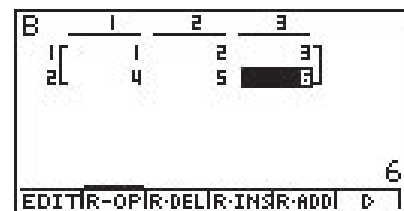

# You can input complex numbers into the cell of a matrix.  
# Displayed cell values show positive integers up to six digits, and negative integers up to five digits (one digit used for the negative sign). Exponential values are shown with up to two digits for the exponent. Fractional values are not displayed.

# You can see the entire value assigned to a cell by using the cursor keys to move the highlighting to the cell whose value you want to view.  
# The amount of memory required for a matrix is 9 bytes per cell. This means that a  $3 \times 3$  matrix requires 81 bytes of memory ( $3 \times 3 \times 9 = 81$ ). Inputting complex numbers into a matrix doubles the amount of memory used.





## • Deleting Matrices

You can delete either a specific matrix or all matrices in memory.

|                   |   |      |   |
|-------------------|---|------|---|
| Matrix            |   |      |   |
| Mat A             | : | 2x   | 2 |
| Mat B             | : | 2x   | 3 |
| Mat C             | : | 2x   | 4 |
| Mat D             | : | 3x   | 2 |
| Mat E             | : | None |   |
| Mat F             | : | None |   |
| DIM   DEL   DEL A |   |      |   |

### • To delete a specific matrix

1. While the Matrix list is on the display, use  $\blacktriangle$  and  $\blacktriangledown$  to highlight the matrix you want to delete.
2. Press **F2** (DEL).
3. Press **EXE** (Yes) to delete the matrix or **ESC** (No) to abort the operation without deleting anything.

### • To delete all matrices

1. While the Matrix list is on the display, press **F3** (DEL·A).
2. Press **EXE** (Yes) to delete all matrices in memory or **ESC** (No) to abort the operation without deleting anything.



# The indicator “None” replaces the dimensions of the matrix you delete.

# Inputting the format or changing the dimensions of a matrix deletes its current contents.



## Matrix Cell Operations

Use the following procedure to prepare a matrix for cell operations.

- While the Matrix list is on the display, use  $\blacktriangle$  and  $\blacktriangledown$  to highlight the name of the matrix you want to use.  
You can jump to a specific matrix by inputting the letter that corresponds to the matrix name. Inputting  $\text{ALPHA}$   $\text{8}$  (N), for example, jumps to Mat N.  
Pressing  $\text{SHIFT}$   $\text{(-)}$  (Ans) jumps to Matrix Memory.
- Press  $\text{EXE}$  and the function menu with the following items appears.
  - {EDIT} ... {cell editing screen}
  - {R-OP} ... {row operation menu}
  - {R•DEL}/{R•INS}/{R•ADD} ... row {delete}/{insert}/{add}
  - {C•DEL}/{C•INS}/{C•ADD} ... column {delete}/{insert}/{add}

All of the following examples use Matrix A.

## Row Calculations

The following menu appears whenever you press  $\text{F2}$  (R-OP) while a recalled matrix is on the display.

- {Swap} ... {row swap}
- {xRow} ... {scalar product of specified row}
- {xRow+} ... {addition of scalar product of specified row to another row}
- {Row+} ... {addition of specified row to another row}

## To swap two rows

• • • • •

**Example** To swap rows two and three of the following matrix :

$$\text{Matrix A} = \begin{bmatrix} 1 & 2 \\ 3 & 4 \\ 5 & 6 \end{bmatrix}$$

$\text{F2}$  (R-OP)  $\text{1}$  (Swap)

Input the number of the rows you want to swap.

$\text{2}$   $\text{EXE}$   $\text{3}$   $\text{EXE}$

```

Row Operation
Swap Row m*Row n
  m :2
  n :3
    
```

$\text{F6}$  (EXE) (or  $\text{EXE}$ )

```

A
  1  2
1 [ 1  2 ]
2 [ 5  6 ]
3 [ 3  4 ]
    
```



• To calculate the scalar product of a row

• • • • •

**Example** To calculate the scalar product of row 2 of the following matrix, multiplying by 4 :

$$\text{Matrix A} = \begin{bmatrix} 1 & 2 \\ 3 & 4 \\ 5 & 6 \end{bmatrix}$$

**F2** (R-OP) **2** ( $\times$ Row)

Input multiplier value.

**4** **EXE**

Specify row number.

**2** **EXE**

**F6** (**EXE**) (or **EXE**)

```
Row Operation
k×Row m→Row m
k :4
m :2
```

```
A      1      2
1 [ 1      2 ]
2 [ 12     16 ]
3 [ 5      6 ]
```

• To calculate the scalar product of a row and add the result to another row

• • • • •

**Example** To calculate the scalar product of row 2 of the following matrix, multiplying by 4 and add the result to row 3 :

$$\text{Matrix A} = \begin{bmatrix} 1 & 2 \\ 3 & 4 \\ 5 & 6 \end{bmatrix}$$

**F2** (R-OP) **3** ( $\times$ Row+)

Input multiplier value.

**4** **EXE**

Specify number of row whose scalar product should be calculated.

**2** **EXE**

Specify number of row where result should be added.

**3** **EXE**

**F6** (**EXE**) (or **EXE**)

```
Row Operation
k×Row m+Row n→Row n
k :4
m :2
n :3
```

```
A      1      2
1 [ 1      2 ]
2 [ 3      4 ]
3 [ 17     22 ]
```



• To add two rows together



**Example** To add row 2 to row 3 of the following matrix :

$$\text{Matrix A} = \begin{bmatrix} 1 & 2 \\ 3 & 4 \\ 5 & 6 \end{bmatrix}$$

**F2** (R-OP) **4** (Row+)

Specify number of row to be added.

**2** **EXE**

Specify number of row to be added to.

**3** **EXE**

**F6** (EXE) (or **EXE**)

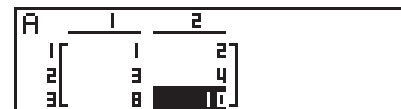
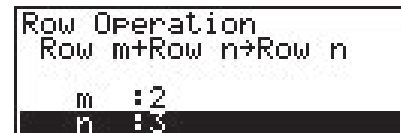

• Row Operations

- {R•DEL} ... {delete row}
- {R•INS} ... {insert row}
- {R•ADD} ... {add row}

• To delete a row



**Example** To delete row 2 of the following matrix :

$$\text{Matrix A} = \begin{bmatrix} 1 & 2 \\ 3 & 4 \\ 5 & 6 \end{bmatrix}$$



**F3** (R•DEL)

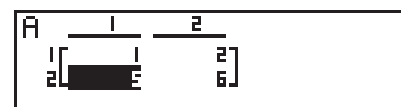
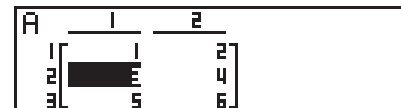



• To insert a row



**Example** To insert a new row between rows one and two of the following matrix :

$$\text{Matrix A} = \begin{bmatrix} 1 & 2 \\ 3 & 4 \\ 5 & 6 \end{bmatrix}$$



| A | 1 | 2 |
|---|---|---|
| 1 | 1 | 2 |
| 2 | E | 4 |
| 3 | 5 | 6 |

**F4** (R•INS)

| A | 1 | 2 |
|---|---|---|
| 1 | 1 | 2 |
| 2 | E | 0 |
| 3 | 3 | 4 |
| 4 | 5 | 6 |

• To add a row



**Example** To add a new row below row 3 of the following matrix :

$$\text{Matrix A} = \begin{bmatrix} 1 & 2 \\ 3 & 4 \\ 5 & 6 \end{bmatrix}$$



| A | 1 | 2 |
|---|---|---|
| 1 | 1 | 2 |
| 2 | 3 | 4 |
| 3 | E | 6 |

**F5** (R•ADD)

| A | 1 | 2 |
|---|---|---|
| 1 | 1 | 2 |
| 2 | 3 | 4 |
| 3 | 5 | 6 |
| 4 | E | 0 |



## • Column Operations

- {C•DEL} ... {delete column}
- {C•INS} ... {insert column}
- {C•ADD} ... {add column}

### • To delete a column



**Example** To delete column 2 of the following matrix :

$$\text{Matrix A} = \begin{bmatrix} 1 & 2 \\ 3 & 4 \\ 5 & 6 \end{bmatrix}$$



|   | 1 | 2 |
|---|---|---|
| 1 | 1 | 2 |
| 2 | 3 | 4 |
| 3 | 5 | 6 |

**F6** (▶) **F1** (C•DEL)

|   | 1 |
|---|---|
| 1 | 1 |
| 2 | 3 |
| 3 | 5 |

### • To insert a column



**Example** To insert a new column between columns 1 and 2 of the following matrix :

$$\text{Matrix A} = \begin{bmatrix} 1 & 2 \\ 3 & 4 \\ 5 & 6 \end{bmatrix}$$



|   | 1 | 2 |
|---|---|---|
| 1 | 1 | 2 |
| 2 | 3 | 4 |
| 3 | 5 | 6 |

**F6** (▶) **F2** (C•INS)

|   | 1 | 2 | 3 |
|---|---|---|---|
| 1 | 1 | 0 | 2 |
| 2 | 3 | 0 | 4 |
| 3 | 5 | 0 | 6 |



• To add a column



**Example** To add a new column to the right of column 2 of the following matrix :

$$\text{Matrix A} = \begin{bmatrix} 1 & 2 \\ 3 & 4 \\ 5 & 6 \end{bmatrix}$$



|   | 1 | 2 |
|---|---|---|
| 1 | 1 | 2 |
| 2 | 3 | 4 |
| 3 | 5 | 6 |

**F6** (▷) **F3** (C•ADD)

|   | 1 | 2 | 3 |
|---|---|---|---|
| 1 | 1 | 2 | 0 |
| 2 | 3 | 4 | 0 |
| 3 | 5 | 6 | 0 |

■ Modifying Matrices Using Matrix Commands

[OPTN]-[MAT]

• To display the matrix commands

1. From the Main Menu, enter the RUN • MAT Mode.
2. Press **OPTN** to display the option menu.
3. Press **F2** (MAT) to display the matrix command menu.

The following describes only the matrix command menu items that are used for creating matrices and inputting matrix data.

- **{Mat}** ... {Mat command (matrix specification)}
- **{Dim}** ... {Dim command (dimension check)}
- **{Augmnt}** ... {Augment command (link two matrices)}
- **{Ident}** ... {Identity command (identity matrix input)}
- **{Fill}** ... {Fill command (identical cell values)}
- **{M→List}** ... {Mat→List command (assign contents of selected column to list file)}



● **Matrix Data Input Format**

[OPTN]-[MAT]-[Mat]

The following shows the format you should use when inputting data to create a matrix using the Mat command.

$$\begin{bmatrix} a_{11} & a_{12} & \dots & a_{1n} \\ a_{21} & a_{22} & \dots & a_{2n} \\ \vdots & \vdots & & \vdots \\ a_{m1} & a_{m2} & \dots & a_{mn} \end{bmatrix}$$

= [ [a<sub>11</sub>, a<sub>12</sub>, ..., a<sub>1n</sub>] [a<sub>21</sub>, a<sub>22</sub>, ..., a<sub>2n</sub>] .... [a<sub>m1</sub>, a<sub>m2</sub>, ..., a<sub>mn</sub>] ]  
→ Mat [letter A through Z]



**Example 1** To input the following data as Matrix A :

$$\begin{bmatrix} 1 & 3 & 5 \\ 2 & 4 & 6 \end{bmatrix}$$

SHIFT + ( [ ) SHIFT + ( [ 1 , 3 , 5  
SHIFT - ( ) SHIFT + ( [ 2 , 4 , 6  
SHIFT - ( ) SHIFT - ( ) → OPTN F2 (MAT)  
1 (Mat) ALPHA X,θ,T (A)

[[1,3,5][2,4,6]]→Mat  
A:

EXE

Matrix name

|   |   |   |   |
|---|---|---|---|
| A | 1 | 2 | 3 |
| 1 |   | 3 | 5 |
| 2 | 2 | 4 | 6 |



# You can also use SHIFT 2 (Mat) in place of OPTN F2 (MAT) 1 (Mat).  
# The maximum value of both *m* and *n* is 255.

# An error occurs if memory becomes full as you are inputting data.  
# You can also use the above format inside a program that inputs matrix data.





• **To input an identity matrix**

[OPTN]-[MAT]-[Ident]

Use the Identity command to create an identity matrix.

• • • • •

**Example 2 To create a 3 × 3 identity matrix as Matrix A**

[OPTN] [F2] (MAT) [6] (Ident)  
 [3] [→] [F2] (MAT) [1] (Mat) [ALPHA] [X,θ,T] (A) [EXE]  
 └─ Number of rows/columns

| A | 1 | 2 | 3 |
|---|---|---|---|
| 1 | 1 | 0 | 0 |
| 2 | 0 | 1 | 0 |
| 3 | 0 | 0 | 1 |

• **To check the dimensions of a matrix**

[OPTN]-[MAT]-[Dim]

Use the Dim command to check the dimensions of an existing matrix.

• • • • •

**Example 3 To check the dimensions of Matrix A, which was input in Example 1**

[OPTN] [F2] (MAT) [2] (Dim)  
 [F2] (MAT) [1] (Mat) [ALPHA] [X,θ,T] (A) [EXE]

| Ans | 1 | 2 | 3 |
|-----|---|---|---|
| 1   | 2 | 3 |   |
| 2   |   |   |   |

The display shows that Matrix A consists of two rows and three columns.

You can also use {Dim} to specify the dimensions of the matrix.

• • • • •

**Example 4 To specify dimensions of 2 rows and 3 columns for Matrix B**

[SHIFT] [X] ({} ) [2] [→] [3] [SHIFT] [÷] ({} ) [→]  
 [OPTN] [F2] (MAT) [2] (Dim)  
 [F2] (MAT) [1] (Mat) [ALPHA] [log] (B) [EXE]

| B | 1 | 2 | 3 |
|---|---|---|---|
| 1 | 1 | 0 | 0 |
| 2 | 0 | 0 | 0 |



## • Modifying Matrices Using Matrix Commands

You can also use matrix commands to assign values to and recall values from an existing matrix, to fill in all cells of an existing matrix with the same value, to combine two matrices into a single matrix, and to assign the contents of a matrix column to a list file.

### • To assign values to and recall values from an existing matrix

[OPTN]-[MAT]-[Mat]

Use the following format with the Mat command to specify a cell for value assignment and recall.

Mat X [ $m, n$ ]

X ..... matrix name (A through Z, or Ans)

$m$  ..... row number

$n$  ..... column number

• • • • •

**Example 1** Assign 10 to the cell at row 1, column 2 of the following matrix :

$$\text{Matrix A} = \begin{bmatrix} 1 & 2 \\ 3 & 4 \\ 5 & 6 \end{bmatrix}$$

[1] [0] [→] [OPTN] [F2] (MAT) [1] (Mat)  
[ALPHA] [X,θ,T] (A) [SHIFT] [+ ] ([) [1] [ , ] [2]  
[SHIFT] [=] ( ) [EXE]

10→Mat A[1,2] 10

• • • • •

**Example 2** Multiply the value in the cell at row 2, column 2 of the above matrix by 5

[OPTN] [F2] (MAT) [1] (Mat)  
[ALPHA] [X,θ,T] (A) [SHIFT] [+ ] ([) [2] [ , ] [2]  
[SHIFT] [=] ( ) [X] [5] [EXE]

Mat A[2,2]×5 20



● **To fill a matrix with identical values and to combine two matrices into a single matrix** [OPTN]-[MAT]-[Fill]/[Augmnt]

Use the Fill command to fill all the cells of an existing matrix with an identical value and the Augment command to combine two existing matrices into a single matrix.



**Example 1 To fill all of the cells of Matrix A with the value 3**

[OPTN] [F2] (MAT) [7] (Fill)  
 [3] [↵] [F2] (MAT) [1] (Mat) [ALPHA] [X,θ,T] (A) [EXE]  
 [F2] (MAT) [1] (Mat) [ALPHA] [X,θ,T] (A) [EXE]

| Ans | 1 | 2 |
|-----|---|---|
| 1   | 3 | 3 |
| 2   | 3 | 3 |
| 3   | 3 | 3 |



**Example 2 To combine the following two matrices :**

$$A = \begin{bmatrix} 1 \\ 2 \end{bmatrix} \quad B = \begin{bmatrix} 3 \\ 4 \end{bmatrix}$$

[OPTN] [F2] (MAT) [5] (Augmnt)  
 [F2] (MAT) [1] (Mat) [ALPHA] [X,θ,T] (A) [↵]  
 [F2] (MAT) [1] (Mat) [ALPHA] [log] (B) [EXE]

| Ans | 1 | 2 |
|-----|---|---|
| 1   | 1 | 3 |
| 2   | 2 | 4 |



# The two matrices you combine must have the same number of rows. An error occurs if you try to combine two matrices that have different numbers of rows.



● To assign the contents of a matrix column to a list

[OPTN]-[MAT]-[M→List]

Use the following format with the Mat→List command to specify a column and a list.

Mat → List (Mat X,  $m$ ) → List  $n$

X = matrix name (A through Z, or Ans)

$m$  = column number

$n$  = list number



**Example** To assign the contents of column 2 of the following matrix to list 1 :

$$\text{Matrix A} = \begin{bmatrix} 1 & 2 \\ 3 & 4 \\ 5 & 6 \end{bmatrix}$$

[OPTN] [F2] (MAT) [8] (M→List)  
 [F2] (MAT) [1] (Mat) [ALPHA] [X,θ,T] (A) [2] [)]  
 [→] [OPTN] [F1] (LIST) [1] (List) [1] [EXE]  
 [OPTN] [F1] (LIST) [1] (List) [EXE]



# You can also use [SHIFT] [1] (List) in place of [OPTN] [F1] (LIST) [1] (List).

# You can use Matrix Answer Memory to assign the results of the above matrix input and edit operations to a matrix variable. To do so, use the following syntax.

- Fill ( $n$ , Mat  $\alpha$ ) → Mat  $\beta$
- Augment (Mat  $\alpha$ , Mat  $\beta$ ) → Mat  $\gamma$

In the above,  $\alpha$ ,  $\beta$ , and  $\gamma$  are any variable names A through Z, and  $n$  is any value. The above does not affect the contents of Matrix Answer Memory.

---

## ■ Matrix Calculations

[OPTN]-[MAT]



Use the matrix command menu to perform matrix calculation operations.

---

### • To display the matrix commands

1. From the Main Menu, enter the RUN • MAT Mode.
2. Press **[OPTN]** to display the option menu.
3. Press **[F2]** (MAT) to display the matrix command menu.

The following describes only the matrix commands that are used for matrix arithmetic operations.

- **{Mat}** ... {Mat command (matrix specification)}
- **{Det}** ... {Det command (determinant command)}
- **{Trn}** ... {Trn command (transpose matrix command)}
- **{Ident}** ... {Identity command (identity matrix input)}

All of the following examples assume that matrix data is already stored in memory.

● Matrix Arithmetic Operations

[OPTN]-[MAT]-[Mat]



● ● ● ● ●

**Example 1** To add the following two matrices (Matrix A + Matrix B) :

$$A = \begin{bmatrix} 1 & 1 \\ 2 & 1 \end{bmatrix} \quad B = \begin{bmatrix} 2 & 3 \\ 2 & 1 \end{bmatrix}$$

[AC] [OPTN] [F2] (MAT) [1] (Mat) [ALPHA] [X,θ,T] (A) [+]  
[F2] (MAT) [1] (Mat) [ALPHA] [log] (B) [EXE]

Ans 1 2  
[ ] [ ]  
1 [ ] [ ]  
2 [ ] [ ]

● ● ● ● ●

**Example 2** Calculate the scalar product to the following matrix using a multiplier value of 5 :

$$\text{Matrix A} = \begin{bmatrix} 1 & 2 \\ 3 & 4 \end{bmatrix}$$

[AC] [5] [OPTN] [F2] (MAT) [1] (Mat)  
[ALPHA] [X,θ,T] (A) [EXE]

Ans 1 2  
[ ] [ ]  
1 [ ] [ ]  
2 [ ] [ ]

● ● ● ● ●

**Example 3** To multiply the two matrices in Example 1 (Matrix A × Matrix B)

[AC] [OPTN] [F2] (MAT) [1] (Mat) [ALPHA] [X,θ,T] (A) [X]  
[F2] (MAT) [1] (Mat) [ALPHA] [log] (B) [EXE]

Ans 1 2  
[ ] [ ]  
1 [ ] [ ]  
2 [ ] [ ]

● ● ● ● ●

**Example 4** To multiply Matrix A (from Example 1) by a 2 × 2 identity matrix

[AC] [OPTN] [F2] (MAT) [1] (Mat) [ALPHA] [X,θ,T] (A) [X]  
[F2] (MAT) [6] (Ident) [2] [EXE]

Ans 1 2  
[ ] [ ]  
1 [ ] [ ]  
2 [ ] [ ]

Number of rows and columns



# The two matrices must have the same dimensions in order to be added or subtracted. An error occurs if you try to add or subtract matrices of different dimensions.

# For multiplication (Matrix 1 × Matrix 2), the number of columns in Matrix 1 must match the number of rows in Matrix 2. Otherwise, an error occurs.

# When performing matrix arithmetic operations, inputting the Identity command at the location of a matrix command (such as Mat A) makes it possible to perform identity matrix calculations.



• **Determinant**

[OPTN]-[MAT]-[Det]

• • • • •

**Example** Obtain the determinant for the following matrix :

$$\text{Matrix A} = \begin{bmatrix} 1 & 2 & 3 \\ 4 & 5 & 6 \\ -1 & -2 & 0 \end{bmatrix}$$

[OPTN] [F2] (MAT) [3] (Det) [F2] (MAT) [1] (Mat)  
[ALPHA] [X,θ,T] (A) [EXE]

Det Mat A -9

• **Matrix Transposition**

[OPTN]-[MAT]-[Trn]

A matrix is transposed when its rows become columns and its columns become rows.

• • • • •

**Example** To transpose the following matrix :

$$\text{Matrix A} = \begin{bmatrix} 1 & 2 \\ 3 & 4 \\ 5 & 6 \end{bmatrix}$$

[OPTN] [F2] (MAT) [4] (Trn) [F2] (MAT) [1] (Mat)  
[ALPHA] [X,θ,T] (A) [EXE]

Ans [ 1 2 3 ]  
[ 2 4 6 ]



# Determinants can be obtained only for square matrices (same number of rows and columns). Trying to obtain a determinant for a matrix that is not square produces an error.

# The determinant of a 2 × 2 matrix is calculated as shown below.

$$|A| = \begin{vmatrix} a_{11} & a_{12} \\ a_{21} & a_{22} \end{vmatrix} = a_{11}a_{22} - a_{12}a_{21}$$

# The determinant of a 3 × 3 matrix is calculated as shown below.

$$|A| = \begin{vmatrix} a_{11} & a_{12} & a_{13} \\ a_{21} & a_{22} & a_{23} \\ a_{31} & a_{32} & a_{33} \end{vmatrix} \\ = a_{11}a_{22}a_{33} + a_{12}a_{23}a_{31} + a_{13}a_{21}a_{32} \\ - a_{11}a_{23}a_{32} - a_{12}a_{21}a_{33} - a_{13}a_{22}a_{31}$$

## • Matrix Inversion

[OPTN]-[MAT]-[x<sup>-1</sup>]



• • • • •

**Example** To invert the following matrix :

$$\text{Matrix A} = \begin{bmatrix} 1 & 2 \\ 3 & 4 \end{bmatrix}$$

[OPTN] [F2] (MAT) [1] (Mat)  
[ALPHA] [X,θ,T] (A) [SHIFT] [x<sup>-1</sup>] [EXE]

| Ans | 1   | 2    |
|-----|-----|------|
| 1   | -E  | 1    |
| 2   | 1.5 | -0.5 |

## • Squaring a Matrix

[OPTN]-[MAT]-[x<sup>2</sup>]

• • • • •

**Example** To square the following matrix :

$$\text{Matrix A} = \begin{bmatrix} 1 & 2 \\ 3 & 4 \end{bmatrix}$$

[OPTN] [F2] (MAT) [1] (Mat) [ALPHA] [X,θ,T] (A) [x<sup>2</sup>] [EXE]

| Ans | 1  | 2  |
|-----|----|----|
| 1   | E  | 10 |
| 2   | 15 | 22 |



# Only square matrices (same number of rows and columns) can be inverted. Trying to invert a matrix that is not square produces an error.

# A matrix with a determinant of zero cannot be inverted. Trying to invert a matrix with determinant of zero produces an error.

# Calculation precision is affected for matrices whose determinant is near zero.

# A matrix being inverted must satisfy the conditions shown below.

$$\mathbf{A A^{-1} = A^{-1} A = E = \begin{bmatrix} 1 & 0 \\ 0 & 1 \end{bmatrix}}$$

The following shows the formula used to invert Matrix A into inverse matrix A<sup>-1</sup>.

$$\mathbf{A = \begin{bmatrix} a & b \\ c & d \end{bmatrix}}$$

$$\mathbf{A^{-1} = \frac{1}{ad - bc} \begin{bmatrix} d & -b \\ -c & a \end{bmatrix}}$$

Note that  $ad - bc \neq 0$ .





● **Raising a Matrix to a Power**

[OPTN]-[MAT]-[ $\wedge$ ]

● ● ● ● ●

**Example** To raise the following matrix to the third power :

$$\text{Matrix A} = \begin{bmatrix} 1 & 2 \\ 3 & 4 \end{bmatrix}$$

[OPTN] [F2] (MAT) [1] (Mat) [ALPHA] [X,θT] (A)  
[ $\wedge$ ] [3] [EXE]

| Ans | 1  | 2   |
|-----|----|-----|
| 1   | 37 | 54  |
| 2   | 81 | 118 |

● **Determining the Absolute Value, Integer Part, Fraction Part, and Maximum Integer of a Matrix**

[OPTN]-[NUM]-[Abs]/[Frac]/[Int]/[Intg]

● ● ● ● ●

**Example** To determine the absolute value of the following matrix :

$$\text{Matrix A} = \begin{bmatrix} 1 & -2 \\ -3 & 4 \end{bmatrix}$$

[OPTN] [F5] (NUM) [1] (Abs)  
[OPTN] [F2] (MAT) [1] (Mat) [ALPHA] [X,θT] (A) [EXE]

| Ans | 1 | 2 |
|-----|---|---|
| 1   | 3 | 2 |
| 2   | 3 | 4 |



- # Determinants and inverse matrices are subject to error due to dropped digits.
- # Matrix operations are performed individually on each cell, so calculations may require considerable time to complete.
- # The calculation precision of displayed results for matrix calculations is  $\pm 1$  at the least significant digit.
- # If a matrix calculation result is too large to fit into Matrix Answer Memory, an error occurs.

# You can use the following operation to transfer Matrix Answer Memory contents to another matrix (or when Matrix Answer Memory contains a determinant to a variable).

$$\text{MatAns} \rightarrow \text{Mat } \alpha$$

In the above,  $\alpha$  is any variable name A through Z. The above does not affect the contents of Matrix Answer Memory.



# Chapter

# 3

# 3

## List Function

A list is a storage place for multiple data items.

This calculator lets you store up to 20 lists in a single file, and you can store up to six files in memory. Stored lists can be used in arithmetic and statistical calculations, and for graphing.

| <i>Element number</i> | <i>Display range</i> | <i>Cell</i> | <i>Column</i> | <i>List name</i> |        |         |     |
|-----------------------|----------------------|-------------|---------------|------------------|--------|---------|-----|
| 1                     | List 1               | List 2      | List 3        | List 4           | List 5 | List 20 |     |
| 1                     | 56                   | 1           | 107           | 3.5              | 4      | 0       |     |
| 2                     | 37                   | 2           | 75            | 6                | 0      | 0       |     |
| 3                     | 21                   | 4           | 122           | 2.1              | 0      | 0       |     |
| 4                     | 69                   | 8           | 87            | 4.4              | 2      | 0       |     |
| 5                     | 40                   | 16          | 298           | 3                | 0      | 0       |     |
| 6                     | 48                   | 32          | 48            | 6.8              | 3      | 0       |     |
| 7                     | 93                   | 64          | 338           | 2                | 9      | 0       |     |
| 8                     | 30                   | 128         | 49            | 8.7              | 0      | 0       | Row |
| ⋮                     | ⋮                    | ⋮           | ⋮             | ⋮                | ⋮      | ⋮       |     |
| ⋮                     | ⋮                    | ⋮           | ⋮             | ⋮                | ⋮      | ⋮       |     |

### 3-1 Inputting and Editing a List

### 3-2 Manipulating List Data

### 3-3 Arithmetic Calculations Using Lists

### 3-4 Switching Between List Files

## 3-1 Inputting and Editing a List

Enter the **STAT** Mode from the Main Menu to input data into a list and to manipulate list data.

### • To input values one-by-one

Use the cursor keys to move the highlighting to the list name or cell you want to select.

|                          | List 1 | List 2 | List 3 | List 4 |
|--------------------------|--------|--------|--------|--------|
| 1                        | 55     | 107    | 0      | 3.5    |
| 2                        | 37     | 75     | 0      | 6      |
| 3                        | 21     | 122    | 0      | 2.1    |
| 4                        | 69     | 87     | 0      | 4.4    |
| 5                        | 40     | 298    | 0      | 3      |
|                          |        |        |        | 56     |
| GRAPHICAL DEL DELA INS D |        |        |        |        |

The screen automatically scrolls when the highlighting is located at either edge of the screen.

The following example is performed starting with the highlighting located at Cell 1 of List 1.

1. Input a value and press **EXE** to store it in the list.

**3** **EXE**

- The highlighting automatically moves down to the next cell for input.

|   | List 1 | List 2 | List 3 | List 4 |
|---|--------|--------|--------|--------|
| 1 | 3      |        |        |        |
| 2 |        |        |        |        |
| 3 |        |        |        |        |
| 4 |        |        |        |        |
| 5 |        |        |        |        |

2. Input the value 4 in the second cell, and then input the result of  $2 + 3$  in the next cell.

**4** **EXE** **2** **+** **3** **EXE**

|   | List 1 | List 2 | List 3 | List 4 |
|---|--------|--------|--------|--------|
| 1 | 3      |        |        |        |
| 2 | 4      |        |        |        |
| 3 | 5      |        |        |        |
| 4 |        |        |        |        |
| 5 |        |        |        |        |



# You can also input the result of an expression or a complex number into a cell.

# You can input value for up to 255 cells in a single list.

● To batch input a series of values

1. Use the cursor keys to move the highlighting to another list.

|   | List 1 | List 2 | List 3 | List 4 |
|---|--------|--------|--------|--------|
| 1 | 3      |        |        |        |

2. Press **SHIFT** **X** ( { ), and then input the values you want, pressing **↵** between each one. Press **SHIFT** **÷** ( } ) after inputting the final value.

**SHIFT** **X** ( { ) **6** **↵** **7** **↵** **8** **SHIFT** **÷** ( } )

|   | List 1 | List 2 | List 3 | List 4 |
|---|--------|--------|--------|--------|
| 1 | 3      |        |        |        |
| 2 | 4      |        |        |        |
| 3 | 5      |        |        |        |
| 4 |        |        |        |        |
| 5 |        |        |        |        |

{6,7,8}

3. Press **EXE** to store all of the values in your list.

**EXE**

|   | List 1 | List 2 | List 3 | List 4 |
|---|--------|--------|--------|--------|
| 1 | 3      | 6      |        |        |
| 2 | 4      | 7      |        |        |
| 3 | 5      | 8      |        |        |
| 4 |        |        |        |        |
| 5 |        |        |        |        |

GRAPHICAL DEL DELA INS | 6

You can also use list names inside of a mathematical expression to input values into another cell. The following example shows how to add the values in each row in List 1 and List 2, and input the result into List 3.

1. Use the cursor keys to move the highlighting to the name of the list where you want the calculation results to be input.

|   | List 1 | List 2 | List 3 | List 4 |
|---|--------|--------|--------|--------|
| 1 | 3      | 6      |        |        |

2. Press **OPTN** and input the expression.

**OPTN** **F1** (LIST) **1** (List) **1** **+**

**OPTN** **F1** (LIST) **1** (List) **2** **EXE**

|   | List 1 | List 2 | List 3 | List 4 |
|---|--------|--------|--------|--------|
| 1 | 3      | 6      | 9      |        |
| 2 | 4      | 7      | 11     |        |
| 3 | 5      | 8      | 13     |        |
| 4 |        |        |        |        |
| 5 |        |        |        |        |

LIST|CPLX|NUM|PROB|HYP| 9



# You can also use **SHIFT** **1** (List) in place of **OPTN** **F1** (LIST) **1** (List).



# Remember that a comma separates values, so you should not input a comma after the final value of the set you are inputting.

Right: {34, 53, 78}



Wrong: {34, 53, 78,}

## ■ Editing List Values

### ● To change a cell value

Use  or  to move the highlighting to the cell whose value you want to change. Input the new value and press  to replace the old data with the new one.

### ● To edit the contents of a cell

1. Use the cursor keys to move the highlighting to the cell whose contents you want to edit.
2. Press  ()  (EDIT) to display the contents of the cell at the bottom of the screen.
3. Make any changes in the data you want.

### ● To delete a cell

1. Use the cursor keys to move the highlighting to the cell you want to delete.

|   | List 1 | List 2 | List 3 | List 4 |
|---|--------|--------|--------|--------|
| 1 | 3      | 6      | 9      |        |
| 2 | 4      | 7      | 11     |        |
| 3 | 5      | 8      | 13     |        |
| 4 |        |        |        |        |
| 5 |        |        |        |        |

4

GRAPHICAL DEL DELA INS | D |

2. Press  (DEL) to delete the selected cell and cause everything below it to be shifted up.

|   | List 1 | List 2 | List 3 | List 4 |
|---|--------|--------|--------|--------|
| 1 | 3      | 6      | 9      |        |
| 2 | 5      | 7      | 11     |        |
| 3 |        | 8      | 13     |        |
| 4 |        |        |        |        |
| 5 |        |        |        |        |

5

GRAPHICAL DEL DELA INS | D |



# The cell delete operation does not affect cells in other lists. If the data in the list whose cell you delete is somehow related to the data in

neighboring lists, deleting a cell can cause related values to become misaligned.

### ● To delete all cells in a list

Use the following procedure to delete all the data in a list.

1. Use the cursor key to move the highlighting to any cell of the list whose data you want to delete.
2. Pressing **[F4]** (DEL•A) causes a confirmation message to appear.
3. Press **[EXE]** (Yes) to delete all the cells in the selected list or **[ESC]** (No) to abort the delete operation without deleting anything.



### ● To insert a new cell

1. Use the cursor keys to move the highlighting to the location where you want to insert the new cell.

|   | List 1 | List 2 | List 3 | List 4 |
|---|--------|--------|--------|--------|
| 1 | 3      | 6      |        |        |
| 2 | 5      | 7      |        |        |
| 3 |        | 8      |        |        |
| 4 |        |        |        |        |
| 5 |        |        |        |        |

2. Press **[F5]** (INS) to insert a new cell, which contains a value of 0, causing everything below it to be shifted down.

|   | List 1 | List 2 | List 3 | List 4 |
|---|--------|--------|--------|--------|
| 1 | 3      | 6      |        |        |
| 2 | 0      | 7      |        |        |
| 3 | 5      | 8      |        |        |
| 4 |        |        |        |        |
| 5 |        |        |        |        |



# The cell insert operation does not affect cells in other lists. If the data in the list where you insert a cell is somehow related to the data in

neighboring lists, inserting a cell can cause related values to become misaligned.

## ■ Sorting List Values

You can sort lists into either ascending or descending order. The highlighting can be located in any cell of the list.

### ● To sort a single list

#### Ascending order

1. While the lists are on the screen, press **F6**(▷)**F1**(SORT) **1**(SortA).

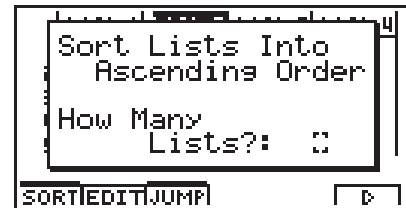

2. The prompt “How Many Lists?: ” appears to ask how many lists you want to sort. Here we will input 1 to indicate we want to sort only one list.

**1** **EXE**



3. In response to the “Select List List No:” prompt, input the number of the list you want to sort.

**1** **EXE**

|   | List 1 | List 2 | List 3 | List 4 |
|---|--------|--------|--------|--------|
| 1 | 0      | 6      |        |        |
| 2 | 3      | 7      |        |        |
| 3 | 5      | 8      |        |        |
| 4 |        |        |        |        |
| 5 |        |        |        |        |

#### Descending order

Use the same procedure as that for the ascending order sort. The only difference is that you should press **2**(SortD) in place of **1**(SortA).



• **To sort multiple lists**

You can link multiple lists together for a sort so that all of their cells are rearranged in accordance with the sorting of a base list. The base list is sorted into either ascending order or descending order, while the cells of the linked lists are arranged so that the relative relationship of all the rows is maintained.

**Ascending order**

1. While the lists are on the screen, press **F6**(▷)**F1**(SORT)**F1**(SortA).



2. The prompt "How Many Lists?: " appears to ask how many lists you want to sort. Here we will sort one base list linked to one other list, so we should input 2.

**F2** **EXE**



3. In response to the "Select Base List List No: " prompt, input the number of the list you want to sort into ascending order. Here we will specify List 1.

**F1** **EXE**



4. In response to the "Select Second List List No:" prompt, input the number of the list you want to link to the base list. Here we will specify List 2.

**F2** **EXE**

|   | List 1 | List 2 | List 3 | List 4 |
|---|--------|--------|--------|--------|
| 1 | 0      | 7      |        |        |
| 2 | 3      | 6      |        |        |
| 3 | 5      | 8      |        |        |
| 4 |        |        |        |        |
| 5 |        |        |        |        |

**Descending order**

Use the same procedure as that for the ascending order sort. The only difference is that you should press **[2]** (SortD) in place of **[1]** (SortA).



# You can specify a value from 1 to 6 as the number of lists for sorting.

# If you specify a list more than once for a single sort operation, an error occurs.

An error also occurs if lists specified for sorting do not have the same number of values (rows).

# Specifying a value of 0 for the number of lists causes all the lists in the file to be sorted. In this case you specify a base list on which all other lists in the file are sorted.

## 3-2 Manipulating List Data

List data can be used in arithmetic and function calculations. In addition, various list data manipulation functions makes manipulation of list data quick and easy.

You can use list data manipulation functions in the **RUN•MAT**, **STAT**, **GRPH•TBL**, **EQUA** and **PRGM Modes**.



### ■ Accessing the List Data Manipulation Function Menu

All of the following examples are performed after entering the **RUN•MAT Mode**.

Press **[OPTN]** and then **[F1]**(LIST) to display the list data manipulation menu, which contains the following items.

- {List}/{Dim}/{Seq}/{Min}/{Max}/{Mean}/{Median}/{Sum}/{Prod}/{CumI}/{%}/{ΔList}/  
{Augmnt}/{Fill}/{L→Mat}

Note that all closing parentheses at the end of the following operations can be omitted.

#### • To count the number of data items in a list [OPTN]-[LIST]-[Dim]

**[OPTN]** **[F1]**(LIST) **[2]** (Dim) **[F1]**(LIST) **[1]** (List) <list number 1-20> **[EXE]**

- The number of cells a list contains is its “dimension.”

• • • • •

**Example** To count the number of values in List 1 (36, 16, 58, 46, 56)

**[AC]** **[OPTN]** **[F1]**(LIST) **[2]** (Dim)  
**[F1]**(LIST) **[1]** (List) **[1]** **[EXE]**

|            |   |
|------------|---|
| Dim List 1 | 5 |
|------------|---|

#### • To create a list or matrix by specifying the number of data items

[OPTN]-[LIST]-[Dim]

Use the following procedure to specify the number of data in the assignment statement and create a list.

<number of data  $n$ > **[→]** **[OPTN]** **[F1]**(LIST) **[2]** (Dim) **[F1]**(LIST) **[1]** (List)  
<list number 1-20> **[EXE]**

$n = 1 \sim 255$

• • • • •

**Example** To create five data items (each of which contains 0) in List 1

**AC** **5** **→** **OPTN** **F1** (LIST) **2** (Dim)  
**F1** (LIST) **1** (List) **1** **EXE**

You can view the newly created list by entering the STAT Mode.

|   | List 1 | List 2 | List 3 | List 4 |
|---|--------|--------|--------|--------|
| 1 | 0      |        |        |        |
| 2 | 0      |        |        |        |
| 3 | 0      |        |        |        |
| 4 | 0      |        |        |        |
| 5 | 0      |        |        |        |

Use the following procedure to specify the number of data rows and columns, and the matrix name in the assignment statement and create a matrix.

**SHIFT** **X** ( { ) <number of row  $m$ > **↵** <number of column  $n$ > **SHIFT** **÷** ( { ) **→**  
**OPTN** **F1** (LIST) **2** (Dim) **F2** (MAT) **1** (Mat) **ALPHA** <matrix name> **EXE**  
 $m, n = 1 \sim 255$ , matrix name; A ~ Z

• • • • •

**Example** To create a 2-row  $\times$  3-column matrix (each cell of which contains 0) in Matrix A

**AC** **SHIFT** **X** ( { ) **2** **↵** **3** **SHIFT** **÷** ( { ) **→**  
**OPTN** **F1** (LIST) **2** (Dim)  
**F2** (MAT) **1** (Mat) **ALPHA** **X,θ,T** (A) **EXE**

The following shows the new contents of Mat A.

| A | 1 | 2 | 3 |
|---|---|---|---|
| 1 | 0 | 0 | 0 |
| 2 | 0 | 0 | 0 |

• **To replace all data items with the same value** **[OPTN]-[LIST]-[Fill]**

**OPTN** **F1** (LIST) **cos** (Fill) <value> **↵** **F1** (LIST) **1** (List) <list number 1-20> **)** **EXE**

• • • • •

**Example** To replace all data items in List 1 with 3

**AC** **OPTN** **F1** (LIST) **cos** (Fill)  
**3** **↵** **F1** (LIST) **1** (List) **1** **)** **EXE**

```
Fill(3,List 1)
Done
```

The following shows the new contents of List 1.

|   | List 1 | List 2 | List 3 | List 4 |
|---|--------|--------|--------|--------|
| 1 | 3      |        |        |        |
| 2 | 3      |        |        |        |
| 3 | 3      |        |        |        |
| 4 | 3      |        |        |        |
| 5 | 3      |        |        |        |



• **To generate a sequence of numbers** [OPTN]-[LIST]-[Seq]

[OPTN] [F1] (LIST) [3] (Seq) <expression> [ ] <variable name> [ ] <start value> [ ] <end value> [ ] <increment> [ ] [EXE]

- The result of this operation is stored in ListAns Memory.

• • • • •

**Example** To input the number sequence  $1^2, 6^2, 11^2$ , into a list, using the function  $f(x) = X^2$ . Use a starting value of 1, an ending value of 11, and an increment of 5

[AC] [OPTN] [F1] (LIST) [3] (Seq) [X,θ,T] [x²] [ ]  
[X,θ,T] [ ] [1] [ ] [1] [1] [ ] [5] [ ] [EXE]

|     |     |
|-----|-----|
| Ans |     |
| 1   | 1   |
| 2   | 36  |
| 3   | 121 |

Specifying an ending value of 12, 13, 14, or 15 produces the same result as shown above, because all of them are less than the value produced by the next increment (16).

• **To find the minimum value in a list** [OPTN]-[LIST]-[Min]

[OPTN] [F1] (LIST) [4] (Min) [F1] (LIST) [1] (List) <list number 1-20> [ ] [EXE]

• • • • •

**Example** To find the minimum value in List 1 (36, 16, 58, 46, 56)

[AC] [OPTN] [F1] (LIST) [4] (Min)  
[F1] (LIST) [1] (List) [1] [ ] [EXE]

|             |    |
|-------------|----|
| Min(List 1) | 16 |
|-------------|----|

• **To find the maximum value in a list** [OPTN]-[LIST]-[Max]

Use the same procedure as when finding the minimum value (Min), except press [5] (Max) in place of [4] (Min).



• **To find which of two lists contains the smallest value** [OPTN]-[LIST]-[Min]

[OPTN] [F1] (LIST) [4] (Min) [F1] (LIST) [1] (List) <list number 1-20>  
 [▶] [F1] (LIST) [1] (List) <list number 1-20> [◀] [EXE]

- The two lists must contain the same number of data items. If they don't, an error occurs.
- The result of this operation is stored in ListAns Memory.

• • • • •

**Example** To find whether List 1 (75, 16, 98, 46, 56) or List 2 (35, 59, 58, 72, 67) contains the smallest value

[OPTN] [F1] (LIST) [4] (Min)  
 [F1] (LIST) [1] (List) [1] [▶]  
 [F1] (LIST) [1] (List) [2] [◀] [EXE]

| Ans |    |
|-----|----|
| 1   | 75 |
| 2   | 16 |
| 3   | 58 |
| 4   | 46 |
| 5   | 56 |

• **To find which of two lists contains the greatest value** [OPTN]-[LIST]-[Max]

Use the same procedure as that for the smallest value, except press [5] (Max) in place of [4] (Min).

- The two lists must contain the same number of data items. If they don't, an error occurs.

• **To calculate the mean of data items** [OPTN]-[LIST]-[Mean]

[OPTN] [F1] (LIST) [6] (Mean) [F1] (LIST) [1] (List) <list number 1-20> [◀] [EXE]

• • • • •

**Example** To calculate the mean of data items in List 1 (36, 16, 58, 46, 56)

[AC] [OPTN] [F1] (LIST) [6] (Mean)  
 [F1] (LIST) [1] (List) [1] [◀] [EXE]

|              |      |
|--------------|------|
| Mean(List 1) | 42.4 |
|--------------|------|

• **To calculate the mean of data items of specified frequency** [OPTN]-[LIST]-[Mean]

This procedure uses two lists: one that contains values and one that indicates the frequency (number of occurrences) of each value. The frequency of the data in Cell 1 of the first list is indicated by the value in Cell 1 of the second list, etc.

- The two lists must contain the same number of data items. If they don't, an error occurs.

[OPTN] [F1] (LIST) [6] (Mean) [F1] (LIST) [1] (List) <list number 1-20 (data)>  
 [▶] [F1] (LIST) [1] (List) <list number 1-20 (frequency)> [◀] [EXE]

• • • • •

**Example** To calculate the mean of data items in List 1 (36, 16, 58, 46, 56), whose frequency is indicated by List 2 (75, 89, 98, 72, 67)

**AC** **OPTN** **F1**(LIST) **6** (Mean)

Mean(List 1,List 2)  
42.07481297

**F1**(LIST) **1** (List) **1** **▸**

**F1**(LIST) **1** (List) **2** **▸** **EXE**



• **To calculate the median of data items in a list** **[OPTN]-[LIST]-[Med]**

**OPTN** **F1**(LIST) **7** (Median) **F1**(LIST) **1** (List) <list number 1-20> **▸** **EXE**

• • • • •

**Example** To calculate the median of data items in List 1 (36, 16, 58, 46, 56)

**AC** **OPTN** **F1**(LIST) **7** (Median)

Median(List 1)  
46

**F1**(LIST) **1** (List) **1** **▸** **EXE**

• **To calculate the median of data items of specified frequency** **[OPTN]-[LIST]-[Med]**

This procedure uses two lists: one that contains values and one that indicates the frequency (number of occurrences) of each value. The frequency of the data in Cell 1 of the first list is indicated by the value in Cell 1 of the second list, etc.

- The two lists must contain the same number of data items. If they don't, an error occurs.

**OPTN** **F1**(LIST) **7** (Median) **F1**(LIST) **1** (List) <list number 1-20 (data)>

**▸** **F1**(LIST) **1** (List) <list number 1-20 (frequency)> **▸** **EXE**

• • • • •

**Example** To calculate the median of values in List 1 (36, 16, 58, 46, 56), whose frequency is indicated by List 2 (75, 89, 98, 72, 67)

**AC** **OPTN** **F1**(LIST) **7** (Median)

Median(List 1,List 2)  
46

**F1**(LIST) **1** (List) **1** **▸**

**F1**(LIST) **1** (List) **2** **▸** **EXE**

- To calculate the sum of data items in a list [OPTN]-[LIST]-[Sum]

[OPTN] [F1] (LIST) [8] (Sum) [F1] (LIST) [1] (List) <list number 1-20> [EXE]

• • • • •

**Example** To calculate the sum of data items in List 1 (36, 16, 58, 46, 56)

[AC] [OPTN] [F1] (LIST) [8] (Sum) [F1] (LIST) [1] (List) [1] [EXE]

|            |     |
|------------|-----|
| Sum List 1 | 212 |
|------------|-----|

- To calculate the cumulate product of a list [OPTN]-[LIST]-[Prod]

[OPTN] [F1] (LIST) [9] (Prod) [F1] (LIST) [1] (List) <list number 1-20> [EXE]

• • • • •

**Example** To calculate the cumulative product of the data in List 1 (2, 3, 6, 5, 4)

[AC] [OPTN] [F1] (LIST) [9] (Prod) [F1] (LIST) [1] (List) [1] [EXE]

|             |     |
|-------------|-----|
| Prod List 1 | 720 |
|-------------|-----|

- To calculate the cumulative frequency of each data item [OPTN]-[LIST]-[Cuml]

[OPTN] [F1] (LIST) [X,0,T] (Cuml) [F1] (LIST) [1] (List) <list number 1-20> [EXE]

- The result of this operation is stored in ListAns Memory.

• • • • •

**Example** To calculate the cumulative frequency of each data item in List 1 (2, 3, 6, 5, 4)

[AC] [OPTN] [F1] (LIST) [X,0,T] (Cuml) [F1] (LIST) [1] (List) [1] [EXE]

|              |   |    |
|--------------|---|----|
| $2+3=$       | 2 | 5  |
| $2+3+6=$     | 3 | 11 |
| $2+3+6+5=$   | 4 | 16 |
| $2+3+6+5+4=$ | 5 | 20 |



• To calculate the percentage represented by each data item

[OPTN]-[LIST]-[%]

[OPTN] [F1] (LIST) [log] (%) [F1] (LIST) [1] (List)<list number 1-20> [EXE]

- The above operation calculates what percentage of the list total is represented by each data item.
- The result of this operation is stored in ListAns Memory.

• • • • •

**Example** To calculate the percentage represented by each data item in List 1 (2, 3, 6, 5, 4)

[AC] [OPTN] [F1] (LIST) [log] (%)

[F1] (LIST) [1] (List) [1] [EXE]

|                              |   |   |    |
|------------------------------|---|---|----|
| $2/(2+3+6+5+4) \times 100 =$ | → | 1 | 10 |
| $3/(2+3+6+5+4) \times 100 =$ | → | 2 | 15 |
| $6/(2+3+6+5+4) \times 100 =$ | → | 3 | 30 |
| $5/(2+3+6+5+4) \times 100 =$ | → | 4 | 25 |
| $4/(2+3+6+5+4) \times 100 =$ | → | 5 | 20 |

| Ans |    |
|-----|----|
| 1   | 10 |
| 2   | 15 |
| 3   | 30 |
| 4   | 25 |
| 5   | 20 |

• To calculate the differences between neighboring data inside a list

[OPTN]-[LIST]-[ΔList]

[OPTN] [F1] (LIST) [In] (ΔList)<list number 1-20> [EXE]

- The result of this operation is stored in ListAns memory.

• • • • •

**Example** To calculate the difference between the data items in List 1 (1, 3, 8, 5, 4)

[AC] [OPTN] [F1] (LIST) [In] (ΔList)

[1] [EXE]

|           |   |   |    |
|-----------|---|---|----|
| $3 - 1 =$ | → | 1 | 2  |
| $8 - 3 =$ | → | 2 | 5  |
| $5 - 8 =$ | → | 3 | -3 |
| $4 - 5 =$ | → | 4 | -1 |

| Ans |    |
|-----|----|
| 1   | 2  |
| 2   | 5  |
| 3   | -3 |
| 4   | -1 |



# You can specify the location of the new list (List 1 through List 20) with a statement like: Δ List 1 → List 2. You cannot specify another memory or ListAns as the destination of the Δ List operation. An error also occurs if you specify a Δ List as the destination of the results of another Δ List operation.

# The number of cells in the new Δ List is one less than the number of cells in the original list.

# An error occurs if you execute Δ List for a list that has no data or only one data item.

• **To combine lists**

[OPTN]-[LIST]-[Augmnt]

- You can combine to different lists into a single list. The result of a list combination operation is stored in ListAns memory.

OPTN F1 (LIST) sin (Augmnt) F1 (LIST) 1 (List) < list number 1-20 >  
 ▸ F1 (LIST) 1 (List) < list number 1-20 > ▸ EXE

• • • • •

**Example To combine the List 1 (-3, -2) and List 2 (1, 9, 10)**

AC OPTN F1 (LIST) sin (Augmnt)  
 F1 (LIST) 1 (List) 1 ▸  
 F1 (LIST) 1 (List) 2 ▸ EXE

| Ans |    |
|-----|----|
| 1   | -3 |
| 2   | -2 |
| 3   | 1  |
| 4   | 9  |
| 5   | 10 |

• **To transfer list contents to Matrix Answer Memory**

[OPTN]-[LIST]-[L→Mat]

OPTN F1 (LIST) tan (L→Mat) F1 (LIST) 1 (List) <list number 1-20>  
 ▸ F1 (LIST) 1 (List) <list number 1-20> ▸ EXE

- You can skip input F1 (LIST) 1 (List) in the part of the above operation.

Example: List → Mat (1, 2) EXE

• • • • •

**Example To transfer the contents of List 1 (2, 3, 6, 5, 4) to column 1, and the contents of List 2 (11, 12, 13, 14, 15) to column 2 of Matrix Answer Memory**

AC OPTN F1 (LIST) tan (L→Mat)  
 F1 (LIST) 1 (List) 1 ▸  
 F1 (LIST) 1 (List) 2 ▸ EXE

| Ans |  | 1 | 2  |
|-----|--|---|----|
| 1   |  | 2 | 11 |
| 2   |  | 3 | 12 |
| 3   |  | 6 | 13 |
| 4   |  | 5 | 14 |
| 5   |  | 4 | 15 |

## 3-3 Arithmetic Calculations Using Lists

You can perform arithmetic calculations using two lists or one list and a numeric value.

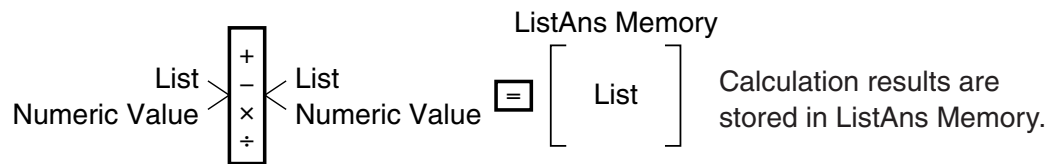

### ■ Error Messages

- A calculation involving two lists performs the operation between corresponding cells. Because of this, an error occurs if the two lists do not have the same number of values (which means they have different “dimensions”).
- An error occurs whenever an operation involving any two cells generates a mathematical error.

### ■ Inputting a List into a Calculation

There are two methods you can use to input a list into a calculation.

#### • To input a specific list by name

1. Press **[OPTN]** to display the first Operation Menu.
  - This is the function key menu that appears in the **RUN • MAT Mode** when you press **[OPTN]**.



2. Press **[F1]** (LIST) to display the List Data Manipulation Menu.
3. Press **[1]** (List) to display the “List” command and input the number of the list you want to specify.

### • To directly input a list of values

You can also directly input a list of values using {, }, and  $\rightarrow$ .

• • • • •

**Example 1 To input the list: 56, 82, 64**

$\text{SHIFT}$   $\times$  ( { ) 5 6  $\rightarrow$  8 2  $\rightarrow$   
6 4  $\text{SHIFT}$   $\div$  ( ) )

{ 56, 82, 64 }  $\rightarrow$

• • • • •

**Example 2 To multiply List 3  $\left( = \begin{bmatrix} 41 \\ 65 \\ 22 \end{bmatrix} \right)$  by the list  $\begin{bmatrix} 6 \\ 0 \\ 4 \end{bmatrix}$**

$\text{OPTN}$   $\text{F1}$  (LIST) 1 (List) 3  $\times$   $\text{SHIFT}$   $\times$  ( { ) 6  $\rightarrow$  0  $\rightarrow$  4  $\text{SHIFT}$   $\div$  ( ) )  $\text{EXE}$

The resulting list  $\begin{bmatrix} 246 \\ 0 \\ 88 \end{bmatrix}$  is stored in ListAns Memory.

### • To assign the contents of one list to another list

Use  $\rightarrow$  to assign the contents of one list to another list.

• • • • •

**Example 1 To assign the contents of List 3 to List 1**

$\text{OPTN}$   $\text{F1}$  (LIST) 1 (List) 3  $\rightarrow$   $\text{F1}$  (LIST) 1 (List) 1  $\text{EXE}$

In place of  $\text{OPTN}$   $\text{F1}$  (LIST) 1 (List) 3 operation in the above procedure, you could input

$\text{SHIFT}$   $\times$  ( { ) 4 1  $\rightarrow$  6 5  $\rightarrow$  2 2  $\text{SHIFT}$   $\div$  ( ) ) .

• • • • •

**Example 2 To assign the list in ListAns Memory to List 1**

$\text{OPTN}$   $\text{F1}$  (LIST) 1 (List)  $\text{SHIFT}$  ( - ) (Ans)  $\rightarrow$   $\text{F1}$  (LIST) 1 (List) 1  $\text{EXE}$



---

### • To recall the value in a specific list cell

You can recall the value in a specific list cell and use it in a calculation. Specify the cell number by enclosing it inside square brackets.

• • • • •

**Example** To calculate the sine of the value stored in Cell 3 of List 2

**sin** **OPTN** **F1** (LIST) **1** (List) **2** **SHIFT** **+** ( [ ) **3** **SHIFT** **-** ( ] ) **EXE**

---

### • To input a value into a specific list cell

You can input a value into a specific list cell inside a list. When you do, the value that was previously stored in the cell is replaced with the new value you input.

• • • • •

**Example** To input the value 25 into Cell 2 of List 3

**2** **5** **→** **OPTN** **F1** (LIST) **1** (List) **3** **SHIFT** **+** ( [ ) **2** **SHIFT** **-** ( ] ) **EXE**

---

## ■ Recalling List Contents

• • • • •

**Example** To recall the contents of List 1

**OPTN** **F1** (LIST) **1** (List) **1** **EXE**

- The above operation displays the contents of the list you specify and also stores them in ListAns Memory. You can then use the ListAns Memory contents in a calculation.

---

### • To use list contents in ListAns Memory in a calculation

• • • • •

**Example** To multiply the list contents in ListAns Memory by 36

**OPTN** **F1** (LIST) **1** (List) **SHIFT** **(←)** (Ans) **×** **3** **6** **EXE**

- The operation **OPTN** **F1** (LIST) **1** (List) **SHIFT** **(←)** (Ans) recalls ListAns Memory contents.
- This operation replaces current ListAns Memory contents with the result of the above calculation.



## ■ Graphing a Function Using a List

When using the graphing functions of this calculator, you can input a function such as  $Y1 = \text{List 1} \times X$ . If List 1 contains the values 1, 2, 3, this function will produce three graphs:  $Y = X$ ,  $Y = 2X$ ,  $Y = 3X$ .

There are certain limitations on using lists with graphing functions.

## ■ Inputting Scientific Calculations into a List

You can use the numeric table generation functions in the Table & Graph Menu to input values that result from certain scientific function calculations into a list. To do this, first generate a table and then use the list copy function to copy the values from the table to the list.

## ■ Performing Scientific Function Calculations Using a List

Lists can be used just as numeric values are in scientific function calculations. When the calculation produces a list as a result, the list is stored in ListAns Memory.

● ● ● ● ●  
**Example** To use List 3  $\begin{bmatrix} 41 \\ 65 \\ 22 \end{bmatrix}$  to perform  $\sin(\text{List 3})$

Use radians as the angle unit.

$\boxed{\sin}$   $\boxed{\text{OPTN}}$   $\boxed{\text{F1}}$   $\boxed{(\text{LIST})}$   $\boxed{1}$   $\boxed{(\text{List})}$   $\boxed{3}$   $\boxed{\text{EXE}}$

The resulting list  $\begin{bmatrix} -0.158 \\ 0.8268 \\ -8\text{E}-3 \end{bmatrix}$  is stored in ListAns Memory.

In place of the  $\boxed{\text{OPTN}}$   $\boxed{\text{F1}}$   $\boxed{(\text{LIST})}$   $\boxed{1}$   $\boxed{(\text{List})}$   $\boxed{3}$  operation in the above procedure, you could input  $\boxed{\text{SHIFT}}$   $\boxed{\times}$   $\boxed{(\{)}$   $\boxed{4}$   $\boxed{1}$   $\boxed{,}$   $\boxed{6}$   $\boxed{5}$   $\boxed{,}$   $\boxed{2}$   $\boxed{2}$   $\boxed{\text{SHIFT}}$   $\boxed{\div}$   $\boxed{(\})}$ .



• • • • •  
**Example**

To use List 1  $\begin{bmatrix} 1 \\ 2 \\ 3 \end{bmatrix}$  and List 2  $\begin{bmatrix} 4 \\ 5 \\ 6 \end{bmatrix}$  to perform List 1<sup>List 2</sup>

This creates a list with the results of  $1^4$ ,  $2^5$ ,  $3^6$ .

**OPTN** **F1** (LIST) **1** (List) **1** **^** **F1** (LIST) **1** (List) **2** **EXE**

The resulting list  $\begin{bmatrix} 1 \\ 32 \\ 729 \end{bmatrix}$  is stored in ListAns Memory.



## 3-4 Switching Between List Files

You can store up to 20 lists (List 1 to List 20) in each file (File 1 to File 6). A simple operation lets you switch between list files.



### • To switch between list files

1. From the Main Menu, enter the STAT Mode.

Press **CTRL** **F3** (SET UP) to display the STAT Mode SET UP screen.

```
Stat Wind :Auto
Resid List :None
List File :File1
Func Type :Y=
Graph Func :On
Backround :None
Angle :Rad ↓
FILE
```

2. Press **F1** (FILE) and then input the number of the list file you want to use.

• • • • •

**Example To select File 3**

**F1** (FILE) **3**

```
Stat Wind :Auto
Resid List :None
List File :File1
Func Type :Y=
Graph Func :On
Backround :None
Select File No.
File[1~6]: 30
```

**EXE**

```
Stat Wind :Auto
Resid List :None
List File :File3
Func Type :Y=
Graph Func :On
Backround :None
```

All subsequent list operations are applied to the lists contained in the file you select (List File 3 in the above example).



# Chapter

# 4

# 4

## Equation Calculations

Your graphic calculator can perform the following three types of calculations:

- Simultaneous linear equations
- High degree equations
- Solve calculations

---

From the Main Menu, enter the EQUA Mode.

- **{SIML}** ... {linear equation with 2 to 30 unknowns}
- **{POLY}** ... {degree 2 to 30 equations}
- **{SOLV}** ... {solve calculation}

Equation

```
Select Type  
F1: Simultaneous  
F2: Polynomial  
F3: Solver  
SIMLPOLYSOLV
```

### 4-1 Simultaneous Linear Equations

### 4-2 High Degree Equations

### 4-3 Solve Calculations

### 4-4 What to Do When an Error Occurs

## 4-1 Simultaneous Linear Equations

### Description

You can solve simultaneous linear equation with two to 30 unknowns.

- Simultaneous Linear Equation with Two Unknowns:

$$a_1x_1 + b_1x_2 = c_1$$

$$a_2x_1 + b_2x_2 = c_2$$

- Simultaneous Linear Equation with Three Unknowns:

$$a_1x_1 + b_1x_2 + c_1x_3 = d_1$$

$$a_2x_1 + b_2x_2 + c_2x_3 = d_2$$

$$a_3x_1 + b_3x_2 + c_3x_3 = d_3$$

$$\vdots$$

### Set Up

1. From the Main Menu, enter the EQUA Mode.

### Execution

2. Select the SIML (simultaneous equation) Mode, and specify the number of unknowns (variables).

You can specify from 2 to 30 unknowns. To specify more than six unknowns, press  $\boxed{F6}(n)$  and then input a value.

3. Sequentially input the coefficients.

The cell that is currently selected for input is highlighted. Each time you input a coefficient the highlighting shifts in the sequence:

$$a_1 \rightarrow b_1 \rightarrow c_1 \rightarrow \dots \rightarrow a_n \rightarrow b_n \rightarrow c_n \rightarrow (n = 2 \text{ to } 30)$$

You can also input fractions, complex numbers, and values assigned to variables as coefficients.

You can cancel the value you are inputting for the current coefficient by pressing  $\boxed{ESC}$  at any time before you press  $\boxed{EXE}$  to store the coefficient value. This returns to the coefficient to what it was before you input anything. You can then input another value if you want.

To change the value of a coefficient that you already stored by pressing  $\boxed{EXE}$ , move the cursor to the coefficient you want to edit. Next, input the value you want to change to or press  $\boxed{F1}(EDIT)$ .

Pressing  $\boxed{F3}(CLR)$  clears all coefficients to zero.

4. Solve the equations.





**Example** To solve the following simultaneous linear equations for  $x$ ,  $y$ , and  $z$

$$\begin{aligned} 4x + y - 2z &= -1 \\ x + 6y + 3z &= 1 \\ -5x + 4y + z &= -7 \end{aligned}$$

### Procedure

- ① **MENU** EQUA
- ② **F1** (SIML)
- F2** (3)
- ③ **4** **EXE** **1** **EXE** **(←)** **2** **EXE** **(←)** **1** **EXE**  
**1** **EXE** **6** **EXE** **3** **EXE** **1** **EXE**  
**(←)** **5** **EXE** **4** **EXE** **1** **EXE** **(←)** **7** **EXE**
- ④ **F6** (SOLV)

|   | a  | b | c  | d  |
|---|----|---|----|----|
| 1 | 4  | 1 | -2 | -1 |
| 2 | 1  | 6 | 3  | 1  |
| 3 | -5 | 4 | 1  | -7 |

EDIT|DEL|CLR| SOLV

### Result Screen

| anX+bnY+CnZ=dn |    |
|----------------|----|
| X              | 1  |
| Y              | -1 |
| Z              | 2  |

1

REPT



# Internal calculations are performed using a 15-digit mantissa, but results are displayed using a 10-digit mantissa and a 2-digit exponent.

# Simultaneous linear equations are solved by inverting the matrix containing the coefficients of the equations. For example, the following shows the solution  $(x_1, x_2, x_3)$  of a simultaneous linear equation with three unknowns.

$$\begin{bmatrix} x_1 \\ x_2 \\ x_3 \end{bmatrix} = \begin{bmatrix} a_1 & b_1 & c_1 \\ a_2 & b_2 & c_2 \\ a_3 & b_3 & c_3 \end{bmatrix}^{-1} \begin{bmatrix} d_1 \\ d_2 \\ d_3 \end{bmatrix}$$

Because of this, precision is reduced as the value of the determinant approaches zero. Also, simultaneous equations with three or more unknowns may take a very long time to solve.

# An error occurs if the calculator is unable to find a solution.

# After calculation is complete, you can press **F1** (REPT), change coefficient values, and then re-calculate.

## 4-2 High Degree Equations

### Description

You can use this calculator to solve high degree equations such as quadratic equations and cubic equations.

- Quadratic Equation:  
 $ax^2 + bx + c = 0$  ( $a \neq 0$ )
- Cubic Equation:  
 $ax^3 + bx^2 + cx + d = 0$  ( $a \neq 0$ )  
⋮



### Set Up

1. From the Main Menu, enter the EQUA Mode.

### Execution

2. Select the POLY (high degree equation) Mode, and specify the degree of the equation. You can specify a degree from 2 to 30. To specify a degree greater than three, press  $\boxed{F3}(n)$  and then input a value.
3. Sequentially input the coefficients.

The cell that is currently selected for input is highlighted. Each time you input a coefficient the highlighting shifts in the sequence:

$$a \rightarrow b \rightarrow c \rightarrow \dots$$

You can also input fractions, complex numbers, and values assigned to variables as coefficients.

You can cancel the value you are inputting for the current coefficient by pressing  $\boxed{ESC}$  at any time before you press  $\boxed{EXE}$  to store the coefficient value. This returns to the coefficient to what it was before you input anything. You can then input another value if you want.

To change the value of a coefficient that you already stored by pressing  $\boxed{EXE}$ , move the cursor to the coefficient you want to edit. Next, input the value you want to change to or press  $\boxed{F1}$ (EDIT).

Pressing  $\boxed{F3}$ (CLR) clears all coefficients to zero.

4. Solve the equations.



# Internal calculations are performed using a 15-digit mantissa, but results are displayed using a 10-digit mantissa and a 2-digit exponent.

# Equations of third degree or higher may take a very long time to solve.

# An error occurs if the calculator is unable to find a solution.

# After calculation is complete, you can press  $\boxed{F1}$ (REPT), change coefficient values, and then re-calculate.



**Example** To solve the cubic equation

$$x^3 - 2x^2 - x + 2 = 0$$

### Procedure

- ① **MENU** EQUA
- ② **F2** (POLY)  
**F2** (3)
- ③ **1** **EXE** **(-)** **2** **EXE** **(-)** **1** **EXE** **2** **EXE**
- ④ **F6** (SOLV)

### Result Screen

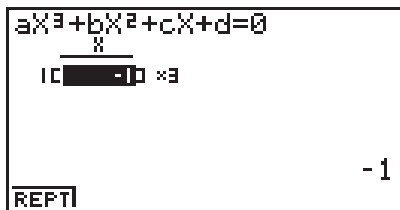
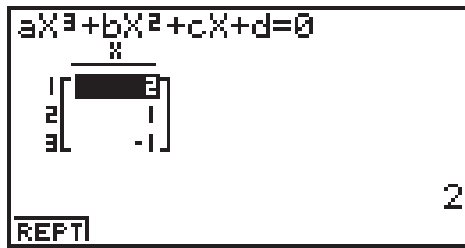

(Multiple Solutions)

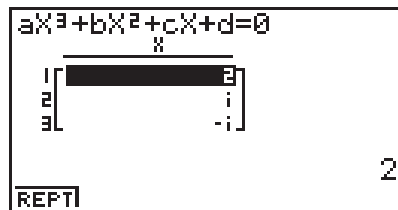

(Complex Number Solution)



## 4-3 Solve Calculations

### Description

The Solve Calculation Mode lets you determine the value of any variable in a formula, without going through the trouble of solving the equation.

---

### Set Up

1. From the Main Menu, enter the EQUA Mode.

### Execution

2. Select the SOLV (Solve) Mode, and input the equation as it is written.  
If you do not input an equals sign, the calculator assumes that the expression is to the left of the equals sign, and there is a zero to the right. \*1
3. In the table of variables that appears on the display, input values for each variable.  
You can also specify values for Upper and Lower to define the upper and lower limits of the range of solutions. \*2
4. Select the variable for which you want to solve to obtain the solution.  
“Lft” and “Rgt” indicate the left and right sides that are calculated using the solution. \*3



\*1 An error occurs if you input more than one equals sign.

\*2 An error occurs if the solution falls outside the range you specify.

\*3 Solutions are approximated using Newton's method. Lft and Rgt values are displayed for confirmation, because Newton's method may produce results that are the real solution.

The closer the difference between the Lft and Rgt values is to zero, the lower degree of error in the result.

# The message “Retry” appears on the display when the calculator judges that convergence is not sufficient for the displayed results.





**Example** An object thrown into the air at initial velocity  $V$  takes time  $T$  to reach height  $H$ . Use the following formula to solve for initial velocity  $V$  when  $H = 14$  (meters),  $T = 2$  (seconds) and gravitational acceleration is  $G = 9.8$  (m/s<sup>2</sup>).

$$H = VT - 1/2 GT^2$$

---

### Procedure

- ① **MENU** EQUA
- ② **F3** (SOLV)
  - ALPHA**  $x^2$  (H) **SHIFT**  $\square$  (=) **ALPHA** **2** (V) **ALPHA**  $\div$  (T) **=** **(** **1** **\div** **2** **)**
  - ALPHA**  $\alpha\frac{\square}{\square}$  (G) **ALPHA**  $\div$  (T)  $x^2$  **EXE**
- ③ **1** **4** **EXE** (H = 14)
  - 0** **EXE** (V = 0)
  - 2** **EXE** (T = 2)
  - 9** **.** **8** **EXE** (G = 9.8)
- ④ Press  $\blacktriangle$  to highlight V = 0, and then press **F6** (SOLV).

---

### Result Screen

```
Eq: H=VT-(1/2)GT²
    U=16.8
    Lft=14
    Ret=14

REPTI
```



## 4-4 What to Do When an Error Occurs

---

### • Error during coefficient value input

Press the **ESC** key to clear the error and return to the value that was registered for the coefficient before you input the value that generated the error. Try inputting a new value again.

---

### • Error during calculation

Press the **ESC** key to clear the error and display coefficient. Try inputting values for the coefficients again.

### ■ Clearing Equation Memories

1. Enter the equation calculation mode (SIML or POLY) you want to use and perform the function key operation required for that mode.
  - In the case of the SIML Mode (**F1**), use number keys to specify the number of unknowns.
  - In the case of the POLY Mode (**F2**), use number keys to specify the degree of the polynomial.
  - If you pressed **F3** (SOLV), advance directly to step 2.
2. Press **F2** (DEL·A).
3. Press **EXE** (Yes) to delete the applicable equation memories or **ESC** (No) to abort the operation without deleting anything.





# Chapter

# 5

# 5

## Graphing

Sections 5-1 and 5-2 of this chapter provide basic information you need to know in order to draw a graph. The remaining sections describe more advanced graphing features and functions.

Select the icon in the Main Menu that suits the type of graph you want to draw or the type of table you want to generate.

- **GRPH·TBL** ... General function graphing or number table generation
- **CONICS** ... Implicit function graphing  
(5-1-5 ~ 5-1-6, 5-11-17~5-11-21)
- **RUN·MAT** ... Manual graphing (5-6-1 ~ 5-6-4)
- **DYNA** ... Dynamic Graph (5-8-1 ~ 5-8-6)
- **RECUR** ... Recursion graphing or number table generation  
(5-9-1 ~ 5-9-8)

- 5-1 Sample Graphs**
- 5-2 Controlling What Appears on a Graph Screen**
- 5-3 Drawing a Graph**
- 5-4 Storing a Graph in Picture Memory**
- 5-5 Drawing Two Graphs on the Same Screen**
- 5-6 Manual Graphing**
- 5-7 Using Tables**
- 5-8 Dynamic Graphing**
- 5-9 Graphing a Recursion Formula**
- 5-10 Changing the Appearance of a Graph**
- 5-11 Function Analysis**

## 5-1 Sample Graphs

---

### ■ How to draw a simple graph (1)

#### Description

To draw a graph, simply input the applicable function.

---

#### Set Up

1. From the Main Menu, enter the GRPH•TBL Mode.

#### Execution

2. Input the function you want to graph.  
Here you would use the V-Window to specify the range and other parameters of the graph. See 5-2-1.
3. Draw the graph.





**Example** To graph  $y = 3x^2$

---

**Procedure**

- ① **MENU** GRPH•TBL
- ② **3** **X,θ,T** **x<sup>2</sup>** **EXE**
- ③ **F5**(DRAW) (or **EXE**)

---

**Result Screen**

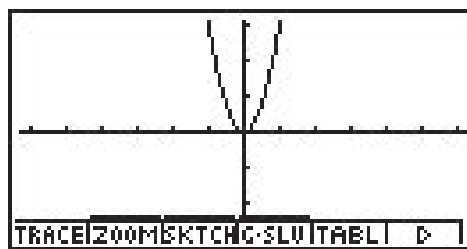

---

## ■ How to draw a simple graph (2)

### Description

You can store up to 20 functions in memory and then select the one you want for graphing.

---

### Set Up

- 1. From the Main Menu, enter the GRPH•TBL Mode.

### Execution

- 2. Specify the function type and input the function whose graph you want to draw.

You can use the GRPH•TBL Mode to draw a graph for the following types of expressions: rectangular coordinate expression, polar coordinate expression, parametric function,  $X = \text{constant}$  expression, inequality.

- F3**(TYPE) **1** (Y =) ... rectangular coordinates
- 2** ( $r =$ ) ... polar coordinates
- 3** (Param) ... parametric function
- 4** ( $X = c$ ) ...  $X = \text{constant}$  function
- 5** (INEQUA) **1** ( $Y >$ ) ~ **4** ( $Y \leq$ ) ... inequality

Repeat this step as many times as required to input all of the functions you want.

Next you should specify which of the functions among those that are stored in memory you want to graph (see 5-3-4). If you do not select specific functions here, the graph operation will draw graphs of all the functions currently stored in memory.

- 3. Draw the graph.





**Example** Input the functions shown below and draw their graphs  
 $Y1 = 2x^2 - 3$ ,  $r2 = 3\sin 2\theta$

**Procedure**

- ① **MENU** GRPH•TBL
- ② **F3**(TYPE) **1** (Y=) **2**  $X,\theta,T$   $x^2$  **-** **3** **EXE**  
**F3**(TYPE) **2** (r=) **3** **sin** **2**  $X,\theta,T$  **EXE**
- ③ **F5**(DRAW)

**Result Screen**

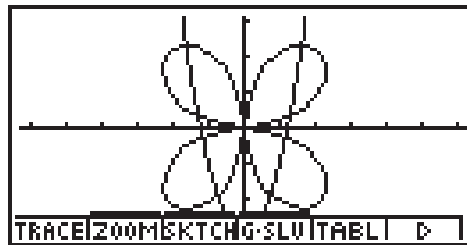

(Param)



(INEQUA)

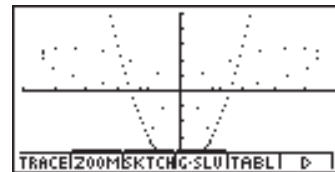

(Plot)



## ■ How to draw a simple graph (3)

### Description

Use the following procedure to graph the function of a parabola, circle, ellipse, or hyperbola.

### Set Up

1. From the Main Menu, enter the CONICS Mode.

### Execution

2. Use the cursor  $\blacktriangle$   $\blacktriangledown$  keys to specify one of the function type as follows.

| Graph Type | Function                                                                                                |
|------------|---------------------------------------------------------------------------------------------------------|
| Parabola   | $X = A (Y - K)^2 + H$ $X = AY^2 + BY + C$ $Y = A (X - H)^2 + K$ $Y = AX^2 + BX + C$                     |
| Circle     | $(X - H)^2 + (Y - K)^2 = R^2$ $AX^2 + AY^2 + BX + CY + D = 0$                                           |
| Ellipse    | $\frac{(X - H)^2}{A^2} + \frac{(Y - K)^2}{B^2} = 1$                                                     |
| Hyperbola  | $\frac{(X - H)^2}{A^2} - \frac{(Y - K)^2}{B^2} = 1$ $\frac{(Y - K)^2}{A^2} - \frac{(X - H)^2}{B^2} = 1$ |

3. Input values for the required variables.
4. Graph the function.





**Example** Graph the circle  $(X-1)^2 + (Y-1)^2 = 2^2$

---

**Procedure**

- ① **MENU** CONICS
- ② **▼** **▼** **▼** **▼** **EXE**
- ③ **1** **EXE** **1** **EXE** **2** **EXE**
- ④ **F6** (DRAW)

---

**Result Screen**

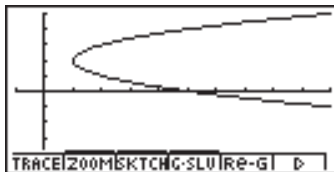
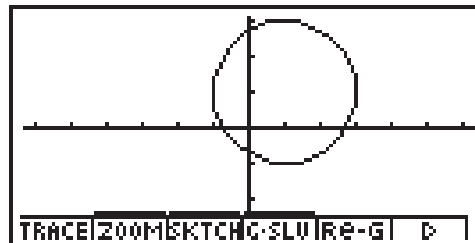

(Parabola)

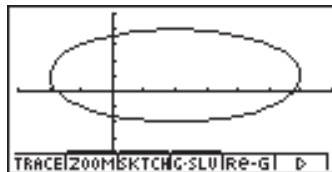

(Ellipse)

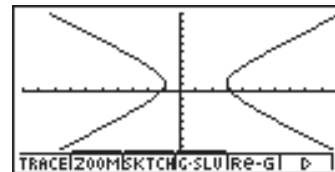

(Hyperbola)



## 5-2 Controlling What Appears on a Graph Screen

### ■ V-Window (View Window) Settings

Use the View Window to specify the range of the  $x$ - and  $y$ -axes, and to set the spacing between the increment on each axis. You should always set the V-Window parameters you want to use before graphing.

#### • To make V-Window settings

1. From the Main Menu, enter the GRPH•TBL Mode.
2. Press **[SHIFT]** **[OPTN]** (V-Window) to display the V-Window setting screen.

##### Rectangular coordinate parameter

- Xmin ... Minimum  $x$ -axis value
- Xmax ... Maximum  $x$ -axis value
- Xscale ... Spacing of  $x$ -axis increments
- Xdot ... Value that corresponds to one  $x$ -axis dot
- Ymin ... Minimum  $y$ -axis value
- Ymax ... Maximum  $y$ -axis value
- Yscale ... Spacing of  $y$ -axis increments

```
View Window
Xmin :-6.3
max :6.3
scale:1
dot :0.1
Ymin :-3.1
max :3.1
INIT|TRIG|STD|STO|RCL
```

##### Polar coordinate parameter

- $T\theta$  min ...  $T$ ,  $\theta$  minimum values
- $T\theta$  max ...  $T$ ,  $\theta$  maximum values
- $T\theta$  ptch ...  $T$ ,  $\theta$  pitch

```
View Window
Ymin :-3.1
max :3.1
scale:1
Tmin :0
max :360
ptch:6
INIT|TRIG|STD|STO|RCL
```

3. Press **[▼]** to move the highlighting, and input an appropriate value for each parameter, pressing **[EXE]** after each.
  - **{[INIT]}/{[TRIG]}/{[STD]}** ... V-Window {initial settings}/{initial settings using specified angle unit}/{standardized settings}
  - **{[STO]}/{[RCL]}** ... V-Window setting {store}/{recall}

After settings are the way you want them, press **[ESC]** or **[SHIFT]** **[ESC]** (QUIT) to exit the V-Window setting screen.\*1



\*1 Pressing **[EXE]** without inputting anything while ■ is displayed exits the View Window setting screen.





---

**• V-Window Setting Precautions**

- Inputting zero for  $T\theta$  ptch causes an error.
- Any illegal input (out of range value, negative sign without a value, etc.) causes an error.
- An error occurs when  $X_{\max}$  is less than  $X_{\min}$ , or  $Y_{\max}$  is less than  $Y_{\min}$ . When  $T\theta$  max is less than  $T\theta$  min,  $T\theta$  ptch becomes negative.
- You can input expressions (such as  $2\pi$ ) as V-Window parameters.
- When the V-Window setting produces an axis that does not fit on the display, the scale of the axis is indicated on the edge of the display closest to the origin.
- Changing the V-Window settings clears the graph currently on the display and replaces it with the new axes only.
- Changing the  $X_{\min}$  or  $X_{\max}$  value causes the  $X_{\text{dot}}$  value to be adjusted automatically. Changing the  $X_{\text{dot}}$  value causes the  $X_{\max}$  value to be adjusted automatically.
- A polar coordinate ( $r =$ ) or parametric graph will appear coarse if the settings you make in the V-Window cause the  $T, \theta$  pitch value to be too large, relative to the differential between the  $T, \theta$  min and  $T, \theta$  max settings. If the settings you make cause the  $T, \theta$  pitch value to be too small relative to the differential between the  $T, \theta$  min and  $T, \theta$  max settings, on the other hand, the graph will take a very long time to draw.
- The following is the input range for V-Window parameters.  
 $-9.999999999\text{E } 97$  to  $9.999999999\text{E } 97$



## ■ Initializing and Standardizing the V-Window

### • To initialize the V-Window

1. From the Main Menu, enter the GRPH•TBL Mode.
2. Press  $\boxed{\text{SHIFT}} \boxed{\text{OPTN}}$  (V-Window).  
This displays the V-Window setting screen.
3. Press  $\boxed{\text{F1}}$  (INIT) to initialize the V-Window.

$$\begin{array}{llll} X_{\min} = -6.3, & X_{\max} = 6.3, & X_{\text{scale}} = 1 & X_{\text{dot}} = 0.1 \\ Y_{\min} = -3.1, & Y_{\max} = 3.1, & Y_{\text{scale}} = 1 & \\ T\theta \text{ min} = 0, & T\theta \text{ max} = 2\pi \text{ (rad)}, & T\theta \text{ ptch} = 2\pi / 60 \text{ (rad)} & \end{array}$$

### • To initialize the V-Window in accordance with an angle unit

In step 3 of the procedure under “To initialize the V-Window” above, press  $\boxed{\text{F2}}$  (TRIG) to initialize the V-Window in accordance with an angle unit.

$$\begin{array}{llll} X_{\min} = -3\pi \text{ (rad)}, & X_{\max} = 3\pi \text{ (rad)}, & X_{\text{scale}} = \pi / 2 \text{ (rad)}, & X_{\text{dot}} = \pi / 21 \text{ (rad)}, \\ Y_{\min} = -1.6, & Y_{\max} = 1.6, & Y_{\text{scale}} = 0.5 & \end{array}$$

### • To standardize the V-Window

The following are the standard V-Window settings of this calculator.

$$\begin{array}{llll} X_{\min} = -10, & X_{\max} = 10, & X_{\text{scale}} = 1, & X_{\text{dot}} = 0.15873015, \\ Y_{\min} = -10, & Y_{\max} = 10, & Y_{\text{scale}} = 1, & \\ T\theta \text{ min} = 0, & T\theta \text{ max} = 2\pi \text{ (rad)}, & T\theta \text{ ptch} = 2\pi / 60 \text{ (rad)} & \end{array}$$

In step 3 of the procedure under “To initialize the V-Window” above, press  $\boxed{\text{F3}}$  (STD) to standardize V-Window settings in accordance with the above.



# Initialization and standardization cause  $T\theta$  min,  $T\theta$  max,  $T\theta$  ptch values to change automatically in accordance with the current angle unit setting as shown below.

Deg Mode:

$$T\theta \text{ min} = 0, \quad T\theta \text{ max} = 360, \quad T\theta \text{ ptch} = 6$$

Gra Mode:

$$T\theta \text{ min} = 0, \quad T\theta \text{ max} = 400, \quad T\theta \text{ ptch} = 400/60$$



## ■ V-Window Memory

You can store up to six sets of V-Window settings in V-Window memory for recall when you need them.

### • To store V-Window settings

1. From the Main Menu, enter the GRPH•TBL Mode.
2. Press **SHIFT** **OPTN** (V-Window) to display the V-Window setting screen, and input the values you want.
3. Press **F4** (STO) to display the pop-up window.
4. Press a number key to specify the V-Window memory where you want to save the settings, and then press **EXE**. Pressing **1** **EXE** stores the settings in V-Window Memory 1 (V-Win1).

### • To recall V-Window memory settings

1. From the Main Menu, enter the GRPH•TBL Mode.
2. Press **SHIFT** **OPTN** (V-Window) to display the V-Window setting screen.
3. Press **F5** (RCL) to display the pop-up window.
4. Press a number key to specify the V-Window memory number for the settings you want to recall, and then press **EXE**. Pressing **1** **EXE** recalls the settings in V-Window Memory 1 (V-Win1).



# Storing V-Window settings to a memory that already contains setting data replaces the previous data with the new settings.

# Recalling settings causes the current V-Window settings to be replaced with those recalled from memory.



---

## ■ Specifying the Graph Range

### Description

You can define a range (start point, end point) for a function before graphing it.

---

### Set Up

1. From the Main Menu, enter the GRPH•TBL Mode.
2. Make V-Window settings.

### Execution

3. Specify the function type and input the function. The following is the syntax for function input.  
Function  $\left[ \right] \text{ [SHIFT] } \left[ \right] \text{ ( [ ) } \text{ Start Point } \left[ \right] \text{ End Point } \text{ [SHIFT] } \left[ \right] \text{ ( [ )}$
4. Draw the graph.





**Example** Graph  $y = x^2 + 3x - 2$  within the range  $-2 \leq x \leq 4$

Use the following V-Window settings.

**Xmin** = -3,    **Xmax** = 5,    **Xscale** = 1

**Ymin** = -10,    **Ymax** = 30,    **Yscale** = 5

### Procedure

- ① **MENU** GRPH•TBL
- ② **SHIFT** **OPTN** (V-Window) **(←)** **3** **EXE** **5** **EXE** **1** **EXE** **(↓)**  
**(←)** **1** **0** **EXE** **3** **0** **EXE** **5** **EXE** **ESC**
- ③ **F3** (TYPE) **1** (Y=) **X,θ,T** **x<sup>2</sup>** **+** **3** **X,θ,T** **-** **2** **↵**  
**SHIFT** **+** **( [ )** **(←)** **2** **↵** **4** **SHIFT** **-** **( ] )** **EXE**
- ④ **F5** (DRAW)

### Result Screen

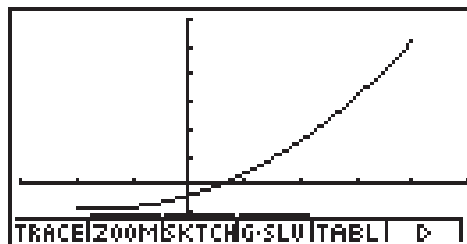

# You can specify a range when graphing rectangular expressions, polar expressions, parametric functions, and inequalities.

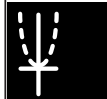

## Zoom

### Description

This function lets you enlarge and reduce the graph on the screen.

### Set Up

1. Draw the graph.

### Execution

2. Specify the zoom type.

**F2**(ZOOM) **F1**(Box) ... Box zoom

Draw a box around a display area, and that area is enlarged to fill the entire screen.

**F2**(Factor)

**F3**(In)/ **F4**(Out) ... Factor zoom

The graph is enlarged or reduced in accordance with the factor you specify, centered on the current pointer location.

**F5**(Auto) ... Auto zoom

V-Window  $y$ -axis settings are automatically adjusted so the graph fills the screen along the  $y$ -axis.

**F6**(Orig) ... Original size

Returns the graph to its original size following a zoom operation.

**F7**(Square) ... Graph correction

V-Window  $x$ -axis values are corrected so they are identical to the  $y$ -axis values.

**F8**(Rnd) ... Coordinate rounding

Rounds the coordinate values at the current pointer location.

**F9**(Intg) ... Integer

Each dot is given a width of 1, which makes coordinate values integers.

**X,θ,T**(Pre) ... Previous

V-Window parameters are returned to what they were prior to the last zoom operation.

**log**(QUICK) ... Quick zoom

Redraws the graph in accordance with the settings stored in a selected V-Window memory.

Box zoom range specification

3. Use the cursor keys to move the pointer (**↔**) in the center of the screen to the location where you want one corner of the box to be, and then press **EXE**.
4. Use the cursor keys to move the pointer. This causes a box to appear on the screen. Move the cursor until the area you want to enlarge is enclosed in the box, and then press **EXE** to enlarge it.





**Example** Graph  $y = (x + 5)(x + 4)(x + 3)$ , and then perform a box zoom.

Use the following V-Window settings.

**Xmin = -8, Xmax = 8, Xscale = 2**

**Ymin = -4, Ymax = 2, Yscale = 1**

### Procedure

- ① **MENU** GRPH•TBL  
**SHIFT** **OPTN** (V-Window) **(←)** **8** **EXE** **8** **EXE** **2** **EXE** **(↓)**  
**(←)** **4** **EXE** **2** **EXE** **1** **EXE** **ESC**  
**F3** (TYPE) **1** (Y=) **( ( X,θ,T + 5 ) )** **( ( X,θ,T + 4 ) )**  
**( ( X,θ,T + 3 ) )** **EXE**  
**F5** (DRAW)
- ② **F2** (ZOOM) **1** (Box)
- ③ **(←)** ~ **(←)** **EXE**
- ④ **(←)** ~ **(←)**, **(↑)** ~ **(↑)** **EXE**

### Result Screen

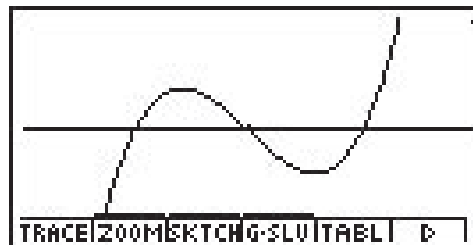
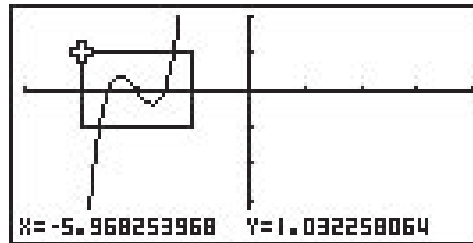

# You cannot specify the same point for and you cannot specify a straight line for the box zoom box.

---

## ■ Factor Zoom

### Description

With factor zoom, you can zoom in or out, centered on the current cursor position.

---

### Set Up

- 1. Draw the graph.

### Execution

- 2. Press **F2** (ZOOM) **2** (Factor) to open a pop-up window for specifying the  $x$ -axis and  $y$ -axis zoom factor. Input the values you want and then press **ESC**.
- 3. Press **F2** (ZOOM) **3** (In) to enlarge the graph, or **F2** (ZOOM) **4** (Out) to reduce it. The graph is enlarged or reduced centered on the current pointer location.
- 4. Use the cursor keys to move the cursor to the point upon which you want the zoom operation to be centered, and then press **EXE** to zoom.





•••••  
**Example**

Enlarge the graphs of the two expressions shown below five times on both the  $x$ - and  $y$ -axis to see if they are tangent.

$$Y1 = (x + 4)(x + 1)(x - 3), \quad Y2 = 3x + 22$$

Use the following V-Window settings.

$$Xmin = -8, \quad Xmax = 8, \quad Xscale = 1$$

$$Ymin = -30, \quad Ymax = 30, \quad Yscale = 5$$

### Procedure

- ① **MENU** GRPH•TBL  
**SHIFT** **OPTN** (V-Window) **(←)** **8** **EXE** **8** **EXE** **1** **EXE** **▼**  
**(←)** **3** **0** **EXE** **3** **0** **EXE** **5** **EXE** **ESC**
- F3** (TYPE) **1** (Y=) **(←)** **X,θ,T** **+** **4** **)** **(←)** **X,θ,T** **+** **1** **)**  
**(←)** **X,θ,T** **-** **3** **)** **EXE**  
**3** **X,θ,T** **+** **2** **2** **EXE**
- F5** (DRAW)
- ② **F2** (ZOOM) **2** (Factor) **5** **EXE** **5** **EXE** **ESC**
- ③ **F2** (ZOOM) **3** (In)
- ④ **▲**~**▲**, **◀**~**◀** **EXE**

### Result Screen

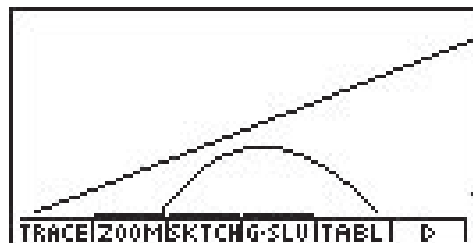
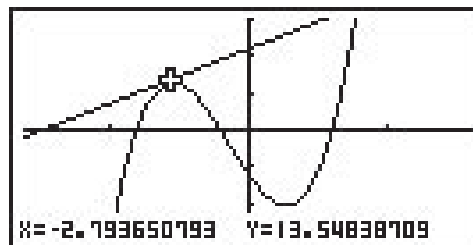

# You can repeat factor zoom to enlarge or reduce a graph even further.

## ■ Turning Function Menu Display On and Off

Press **CTRL** **0** to toggle display of the menu at the bottom of the screen on and off.

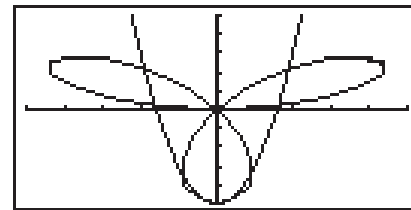
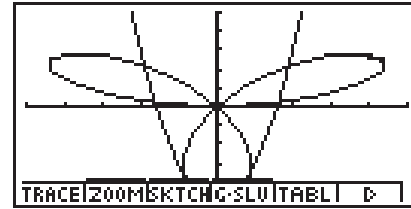

Turning off the function menu display makes it possible to view part of a graph hidden behind it. When you are using the trace function or other functions during which the function menu is normally not displayed, you can turn on the menu display to execute a menu command.



# If a pull-up menu is open when you press **CTRL** **0** to turn off menu display, the pull-up menu remains on the screen.



## ■ About the Calc Window

Pressing **CTRL** **F4** (CAT/CAL) while a graph or number table is on the display opens the Calc Window. You can use the Calc Window to perform calculations with values obtained from graph analysis, or to change the value assigned to variable A in  $Y = AX$  and other expressions and then redraw the graph.

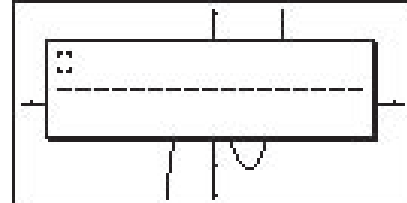

Press **ESC** to close the Calc Window.



# After using the Calc Window to change the value of a variable connected with a graph or table, be sure to always execute **Re-G** (re-graph) or **Re-T** (re-calculate table). Doing so ensures that the displayed graph or table is current.

# Calc Window cannot be used in the RUN • MAT Mode, while a program is running, or in combination with Dynamic Graph.

# Calc Window cannot be used in combination with V-Window or the table range setting screen.  
# Complex number calculations cannot be performed on the Calc Window.

## 5-3 Drawing a Graph

You can store up to 20 functions in memory. Functions in memory can be edited, recalled, and graphed.

### ■ Specifying the Graph Type

Before you can store a graph function in memory, you must first specify its graph type.

- While the Graph function list is on the display, press **F6**(▷) **F3**(TYPE) to display the graph type menu, which contains the following items.
  - {Y=}/{r=}/{Param}/{X=c}** ... {rectangular coordinate}/{polar coordinate}/{parametric}/  
{X=constant}<sup>\*1</sup> graph
  - {INEQUA}**
    - {Y>}/{Y<}/{Y≥}/{Y≤}** ... {Y>f(x)}/{Y<f(x)}/{Y≥f(x)}/{Y≤f(x)} inequality graph
- Press the number key that corresponds to the graph type you want to specify.



### ■ Storing Graph Functions

- To store a rectangular coordinate function (**Y =**) <sup>\*2</sup>

• • • • •

**Example** To store the following expression in memory area Y1 :  $y = 2x^2 - 5$

**F3** (TYPE) **1** (Y =) (Specifies rectangular coordinate expression.)

**2** **X,θ,T** **x<sup>2</sup>** **=** **5** (Inputs expression.)

**EXE** (Stores expression.)

```
Graph Func : Y=
Y1 2X2-5
```

- To store a polar coordinate function (**r =**) <sup>\*2</sup>

• • • • •

**Example** To store the following expression in memory area r2 :  $r = 5 \sin 3\theta$

**F3** (TYPE) **2** (r =) (Specifies polar coordinate expression.)

**5** **sin** **3** **X,θ,T** (Inputs expression.)

**EXE** (Stores expression.)



<sup>\*1</sup> Attempting to draw a graph for an expression in which X is input for an X = constant expression results in an error.

<sup>\*2</sup> A function cannot be stored into a memory area that already contains a function of a different type from the one you are trying to store. Select a memory area that contains a function that is the same type as the one you are storing, or delete the function in the memory area to which you are trying to store.

• To store a parametric function <sup>\*1</sup>



**Example** To store the following functions in memory areas X<sub>t3</sub> and Y<sub>t3</sub> :

$$x = 3 \sin T$$

$$y = 3 \cos T$$

**F3** (TYPE) **3** (Param) (Specifies parametric expression.)

**3** **sin** **X,θ,T** **EXE** (Inputs and stores  $x$  expression.)

**3** **cos** **X,θ,T** **EXE** (Inputs and stores  $y$  expression.)

• To store an  $X = \text{constant}$  expression <sup>\*2</sup>



**Example** To store the following expression in memory area X<sub>4</sub> :

$$X = 3$$

**F3** (TYPE) **4** ( $X = c$ ) (Specifies  $X = \text{constant}$  expression.)

**3** (Inputs expression.)

**EXE** (Stores expression.)

- Inputting  $X$ ,  $Y$ ,  $T$ ,  $r$ , or  $\theta$  for the constant in the above procedures causes an error.

• To store an inequality <sup>\*2</sup>



**Example** To store the following inequality in memory area Y<sub>5</sub> :

$$y > x^2 - 2x - 6$$

**F3** (TYPE) **5** (INEQUA) **1** ( $Y >$ ) (Specifies an inequality.)

**X,θ,T** **x<sup>2</sup>** **=** **2** **X,θ,T** **=** **6** (Inputs expression.)

**EXE** (Stores expression.)



<sup>\*1</sup>You will not be able to store the expression in an area that already contains a rectangular coordinate expression, polar coordinate expression,  $X = \text{constant}$  expression or inequality. Select another area to store your expression or delete the existing expression first.

<sup>\*2</sup>A function cannot be stored into a memory area that already contains a function of a different type from the one you are trying to store. Select a memory area that contains a function that is the same type as the one you are storing, or delete the function in the memory area to which you are trying to store.





## ■ Editing and Deleting Functions

### • To edit a function in memory

• • • • •

**Example** To change the expression in memory area Y1 from  $y = 2x^2 - 5$  to  $y = 2x^2 - 3$

 (Displays cursor.)

     (Changes contents.)

 (Stores new graph function.)

### • To change the type of a function <sup>\*1</sup>

1. While the Graph function list is on the display, press  or  to move the highlighting to the area that contains the function whose type you want to change.

2. Press  (TYPE)  (CONV).



3. Select the function type you to change to.



• • • • •



**Example** To change the function in memory area Y1 from  $y = 2x^2 - 3$  to  $y < 2x^2 - 3$

 (TYPE)  (CONV)  (Y<) (Changes the function type to “Y<”.)

### • To delete a function

1. While the Graph function list is on the display, press  or  to move the highlighting to the area that contains the function you want to delete.

2. Press  (DEL) or .

3. Press  (Yes) to delete the function for  (No) to abort the procedure without deleting anything.



<sup>\*1</sup>The function type can be changed for rectangular coordinate functions and inequalities only.

# Parametric functions come in pairs (Xt and Yt).  
When editing a parametric function, clear the graph functions and re-input from the beginning.

## ■ Selecting Functions for Graphing

### • To specify the draw/non-draw status of a graph



**Example** To select the following functions for drawing :

$$Y1 = 2x^2 - 5, r2 = 5 \sin 3\theta$$

Use the following V-Window settings.

$$Xmin = -5, \quad Xmax = 5, \quad Xscale = 1$$

$$Ymin = -5, \quad Ymax = 5, \quad Yscale = 1$$

$$T\theta \text{ min} = 0, \quad T\theta \text{ max} = \pi, \quad T\theta \text{ ptch} = 2\pi / 60$$

$\nabla$   $\nabla$  (Select a memory area that contains a function for which you want to specify non-draw.)

$\boxed{F1}$  (SEL) (Specifies non-draw.)

$\boxed{F5}$  (DRAW) or  $\boxed{EXE}$  (Draws graphs.)

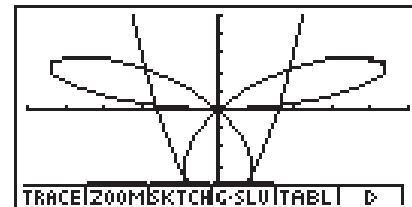

- Each press of  $\boxed{F1}$  (SEL) toggles a graph between draw and non-draw.
- Pressing  $\boxed{CTRL} \boxed{F5}$  (G $\leftrightarrow$ T) or  $\boxed{ESC}$  returns to the Graph function list.
- You can use the SET UP screen settings to alter the appearance of the graph screen as shown below.

- Grid: On

This setting causes dots to appear at the grid intersects on the display.

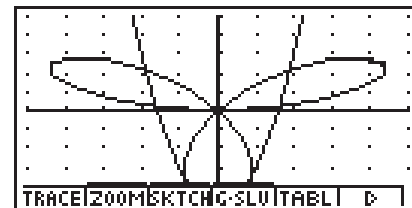

- Axes: Off

This setting clears the axis lines from the display.

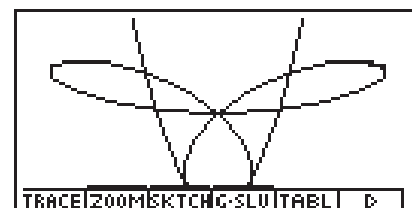

- Label: On

This setting displays labels for the x- and y-axes.

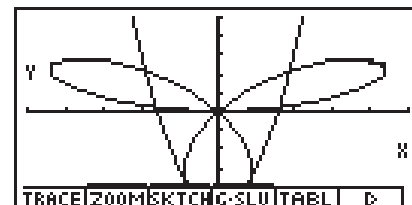

## ■ Graph Memory

Graph memory lets you store up to 20 sets of graph function data and recall it later when you need it.

A single save operation saves the following data in graph memory.

- All graph functions in the currently displayed Graph function list (up to 20)
- Graph types
- Draw/non-draw status
- View Window settings (1 set)

### • To store graph functions in graph memory

1. Press **[F5]** (GMEM) **[1]** (Store) to display the pop-up window.
2. Press a number key to specify the Graph memory where you want to save the graph function, and then press **[EXE]**. Pressing **[1]** **[EXE]** stores the graph function to Graph Memory 1 (G-Mem1).
  - There are 20 graph memories numbered G-Mem1 to G-Mem20.

### • To recall a graph function

1. Press **[F5]** (GMEM) **[2]** (Recall) to display the pop-up window.
2. Press a number key to specify the Graph memory for the function you want to recall, and then press **[EXE]**. Pressing **[1]** **[EXE]** recalls the graph function in Graph Memory 1 (G-Mem1).



# Storing a function in a memory area that already contains a function replaces the existing function with the new one.  
# If the data exceeds the calculator's remaining memory capacity, an error occurs.

# Recalling data from graph memory causes any data currently on the Graph function list to be deleted.





## 5-4 Storing a Graph in Picture Memory

You can save up to 20 graphic images in picture memory for later recall. You can overdraw the graph on the screen with another graph stored in picture memory.

### • To store a graph in picture memory

1. After graphing in GRPH•TBL Mode, press **F6** ( $\triangleright$ ) **F1** (PICT) **1** (Store) to display the pop-up window.
2. Press a number key to specify the Picture memory where you want to save the picture, and then press **EXE**. Pressing **1** **EXE** stores the picture function to Picture Memory 1 (Pict 1).
  - There are 20 picture memories numbered Pict 1 to Pict 20.

### • To recall a stored graph

1. After graphing in GRPH•TBL Mode, press **F6** ( $\triangleright$ ) **F1** (PICT) **2** (Recall) to display the pop-up window.
2. Press a number key to specify the Picture memory for the picture you want to recall, and then press **EXE**. Pressing **1** **EXE** recalls the picture function in Picture Memory 1 (Pict 1).



# Storing a graphic image in a memory area that already contains a graphic image replaces the existing graphic image with the new one.

# A dual Graph screen or any other type of graph that uses a split screen cannot be saved in picture memory.



## 5-5 Drawing Two Graphs on the Same Screen

### ■ Copying the Graph to the Sub-screen

#### Description

Dual Graph lets you split the screen into two parts. Then you can graph two different functions in each for comparison, or draw a normal size graph on one side and its enlarged version on the other side. This makes Dual Graph a powerful graph analysis tool.

With Dual Graph, the left side of the screen is called the “main screen,” while the right side is called the “sub-screen.”

- **Main Screen**

The graph in the main screen is actually drawn from a function.

- **Sub-screen**

The graph on the sub-screen is produced by copying or zooming the main screen graph. You can even make different V-Window settings for the sub-screen and main screen.

#### Set Up

1. From the Main Menu, enter the GRPH•TBL Mode.
2. On the SET UP screen, select G+G for Dual Screen.
3. Make V-Window settings for the main screen.  
Press **F6** (RIGHT) to display the sub-graph settings screen. Pressing **F6** (LEFT) returns to the main screen setting screen.

#### Execution

4. Store the function, and draw the graph in the main screen.
5. Perform the Dual Graph operation you want.
  - F4** (COPY) ... Duplicates the main screen graph in the sub-screen
  - F5** (SWAP) ... Swaps the main screen contents and sub-screen contents



● ● ● ● ●  
**Example**

Graph  $y = x(x + 1)(x - 1)$  in the main screen and sub-screen.

Use the following V-Window settings.

(Main Screen)

**Xmin** = -2,    **Xmax** = 2,    **Xscale** = 0.5

**Ymin** = -2,    **Ymax** = 2,    **Yscale** = 1

(Sub-screen)

**Xmin** = -4,    **Xmax** = 4,    **Xscale** = 1

**Ymin** = -3,    **Ymax** = 3,    **Yscale** = 1

---

**Procedure**

- ① **MENU** GRPH•TBL
- ② **CTRL** **F3** (SET UP) **▼** **▼** **▼** **F2** (G+G) **ESC**
- ③ **SHIFT** **OPTN** (V-Window) **(←)** **2** **EXE** **2** **EXE** **0** **.** **5** **EXE** **▼**  
**(←)** **2** **EXE** **2** **EXE** **1** **EXE**  
**F6** (RIGHT) **(←)** **4** **EXE** **4** **EXE** **1** **EXE** **▼**  
**(←)** **3** **EXE** **3** **EXE** **1** **EXE** **ESC**
- ④ **F3** (TYPE) **1** (Y=) **(X,θ,T)** **(←)** **(X,θ,T)** **+** **1** **)** **(←)** **(X,θ,T)** **-** **1** **)** **EXE**  
**F5** (DRAW)
- ⑤ **F6** (**▷**) **F4** (COPY)

---

**Result Screen**

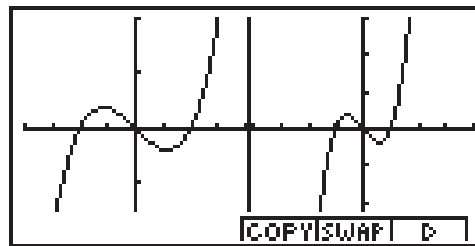

---

## ■ Graphing Two Different Functions

### Description

Use the following procedure to graph different functions in the main screen and sub-screen.

---

### Set Up

1. From the Main Menu, enter the GRPH•TBL Mode.
2. On the SET UP screen, select G+G for Dual Screen.
3. Make V-Window settings for the main screen.  
Press **F6** (RIGHT) to display the sub-graph settings screen. Pressing **F6** (LEFT) returns to the main screen setting screen.

### Execution

4. Store the functions for the main screen and sub-screen.
5. Select the function of the graph that you want to eventually have in the sub-screen.
6. Draw the graph in the main screen.
7. Swap the main screen and sub-screen contents.
8. Return to the function screen.
9. Select the function of the next graph you want in the main screen.
10. Draw the graph in the main screen.



● ● ● ● ●  
**Example**

Graph  $y = x(x + 1)(x - 1)$  in the main screen, and  $y = 2x^2 - 3$  in the sub-screen.

Use the following V-Window settings.

(Main Screen)

**Xmin = -4, Xmax = 4, Xscale = 1**

**Ymin = -5, Ymax = 5, Yscale = 1**

(Sub-screen)

**Xmin = -2, Xmax = 2, Xscale = 0.5**

**Ymin = -2, Ymax = 2, Yscale = 1**

---

**Procedure**

- ① **MENU** GRPH•TBL
- ② **CTRL** **F3** (SET UP) **▼** **▼** **▼** **F2** (G+G) **ESC**
- ③ **SHIFT** **OPTN** (V-Window) **(←)** **4** **EXE** **4** **EXE** **1** **EXE** **▼**  
**(←)** **5** **EXE** **5** **EXE** **1** **EXE**  
**F6** (RIGHT) **(←)** **2** **EXE** **2** **EXE** **0** **.** **5** **EXE** **▼**  
**(←)** **2** **EXE** **2** **EXE** **1** **EXE** **ESC**
- ④ **F3** (TYPE) **1** (Y=) **(X,θ,T)** **(** **(X,θ,T)** **+** **1** **)** **(** **(X,θ,T)** **-** **1** **)** **EXE**  
**2** **(X,θ,T)** **x<sup>2</sup>** **-** **3** **EXE**
- ⑤ **▲** **▲** **F1** (SEL)
- ⑥ **F5** (DRAW)
- ⑦ **F6** (▷) **F5** (SWAP)
- ⑧ **ESC**
- ⑨ **F1** (SEL)
- ⑩ **F5** (DRAW)

---

**Result Screen**

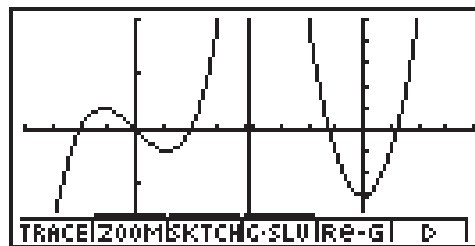

---

## ■ Using Zoom to Enlarge the Sub-screen

### Description

Use the following procedure to enlarge the main screen graph and then move it to the sub-screen.

---

### Set Up

1. From the Main Menu, enter the GRPH•TBL Mode.
2. On the SET UP screen, select G+G for Dual Screen.
3. Make V-Window settings for the main screen.

### Execution

4. Input the function and draw the graph in the main screen.
5. Use Zoom to enlarge the graph, and then move it to the sub-screen.



• • • • •  
**Example**

Draw the graph  $y = x(x + 1)(x - 1)$  in the main screen, and then use **Box Zoom** to enlarge it.

Use the following V-Window settings.

(Main Screen)

**Xmin = -2, Xmax = 2, Xscale = 0.5**

**Ymin = -2, Ymax = 2, Yscale = 1**

---

**Procedure**

- ① **MENU** GRPH•TBL
- ② **CTRL** **F3** (SET UP) **▼** **▼** **▼** **F2** (G+G) **ESC**
- ③ **SHIFT** **OPTN** (V-Window) **(←)** **2** **EXE** **2** **EXE** **0** **.** **5** **EXE** **▼**  
**(←)** **2** **EXE** **2** **EXE** **1** **EXE** **ESC**
- ④ **F3** (TYPE) **1** (Y=) **(X,θ,T)** **(←)** **(X,θ,T)** **+** **1** **)** **(←)** **(X,θ,T)** **-** **1** **)** **EXE**  
**F5** (DRAW)
- ⑤ **F2** (ZOOM) **1** (BOX)  
**▼** ~ **▼** **▶** ~ **▶** **EXE**  
**▲** ~ **▲** **◀** ~ **◀** **EXE**

---

**Result Screen**

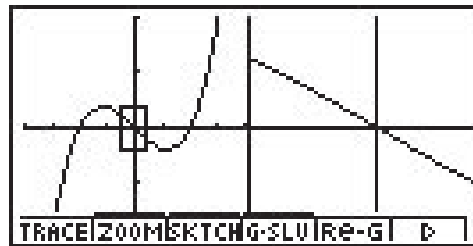

## 5-6 Manual Graphing

---

### ■ Rectangular Coordinate Graph

#### Description

Inputting the Graph command in the RUN • MAT Mode enables drawing of rectangular coordinate graphs.

---

#### Set Up

1. From the Main Menu, enter the RUN • MAT Mode.
2. Make V-Window settings.

#### Execution

3. Input the commands for drawing the rectangular coordinate graph.
4. Input the function.





● ● ● ● ●  
**Example**

Graph  $y = 2x^2 + 3x - 4$

Use the following V-Window settings.

$X_{min} = -5, \quad X_{max} = 5, \quad X_{scale} = 2$

$Y_{min} = -10, \quad Y_{max} = 10, \quad Y_{scale} = 2$

**Procedure**

- ① **MENU** RUN•MAT
- ② **SHIFT** **OPTN** (V-Window) **(←)** **5** **EXE** **5** **EXE** **2** **EXE** **(↓)**  
**(←)** **1** **0** **EXE** **1** **0** **EXE** **5** **EXE** **ESC**
- ③ **OPTN** **F6** (**▷**) **F6** (**▷**) **F2** (SKTCH) **1** (CIs) **EXE**  
**F2** (SKTCH) **4** (GRAPH) **1** (Y=)
- ④ **2** **X,θ,T** **x<sup>2</sup>** **+** **3** **X,θ,T** **-** **4** **EXE**

**Result Screen**

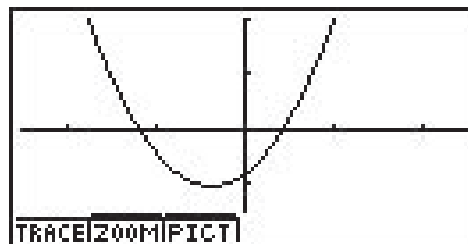

---

## ■ Integration Graph

### Description

Inputting the Graph command in the RUN • MAT Mode enables graphing of functions produced by an integration calculation.

The calculation result is shown in the lower left of the display, and the calculation range is blackened in the graph.

---

### Set Up

1. From the Main Menu, enter the RUN • MAT Mode.
2. Make V-Window settings.

### Execution

3. Input graph commands for the integration graph.
4. Input the function.





**Example** Draw the graph for the integral  $y = \int_{-2}^1 (x + 2)(x - 1)(x - 3) dx$ , using 10 as the number of divisions.

Use the following V-Window settings.

Xmin = -4, Xmax = 4, Xscale = 1

Ymin = -8, Ymax = 12, Yscale = 5

### Procedure

- ① **MENU** RUN•MAT
- ② **SHIFT** **OPTN** (V-Window) **(←)** **4** **EXE** **4** **EXE** **1** **EXE** **(↓)**  
**(←)** **8** **EXE** **1** **2** **EXE** **5** **EXE** **ESC**
- ③ **OPTN** **F6** (**▷**) **F6** (**▷**) **F2** (SKTCH) **1** (Cls) **EXE**  
**F2** (SKTCH) **4** (GRAPH) **2** ( $\int dx$ )
- ④ **(←)** **X,θ,T** **+** **2** **)** **(←)** **X,θ,T** **-** **1** **)** **(←)** **X,θ,T** **-** **3** **)** **,**  
**(←)** **2** **,** **1** **,** **1** **0** **EXE**

### Result Screen

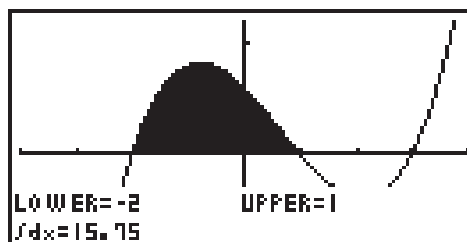

---

## ■ Drawing Multiple Graphs on the Same Screen

### Description

Use the following procedure to assign various values to a variable contained in an expression and overwrite the resulting graphs on the screen.

---

### Set Up

1. From the Main Menu, Enter GRPH•TBL Mode.
2. Make V-Window settings.

### Execution

3. Specify the function type and input the function. The following is the syntax for function input.  
Expression containing one variable  $\boxed{\text{,}}$   $\boxed{\text{SHIFT}}$   $\boxed{+}$   $\boxed{(}$   $\boxed{)}$  variable  $\boxed{\text{SHIFT}}$   $\boxed{=}$  (=)  
value  $\boxed{\text{,}}$  value  $\boxed{\text{,}}$  ...  $\boxed{\text{,}}$  value  $\boxed{\text{SHIFT}}$   $\boxed{-}$   $\boxed{)}$
4. Draw the graph.





**Example** To graph  $y = Ax^2 - 3$  as the value of A changes in the sequence 3, 1, -1.

Use the following V-Window settings.

**Xmin = -5, Xmax = 5, Xscale = 1**

**Ymin = -10, Ymax = 10, Yscale = 2**

### Procedure

- ① **MENU** GRPH•TBL
- ② **SHIFT** **OPTN** (V-Window) **(←)** **5** **EXE** **5** **EXE** **1** **EXE** **(↓)**  
**(←)** **1** **0** **EXE** **1** **0** **EXE** **2** **EXE** **ESC**
- ③ **F3** (TYPE) **1** (Y=) **(ALPHA)** **(X,θ,T)** (A) **(X,θ,T)** **x<sup>2</sup>** **-** **3** **,**  
**SHIFT** **+** **( [ )** **(ALPHA)** **(X,θ,T)** (A) **SHIFT** **(=)** **3** **,** **1** **,** **(←)** **1** **SHIFT** **(-)** **( [ )** **EXE**
- ④ **F5** (DRAW)

### Result Screen

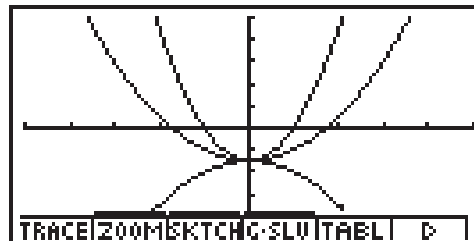

- # The value of only one of the variables in the expression can change.
- # Any of the following cannot be used for the variable name: X, Y, r, θ, T.
- # You cannot assign a variable to the variable inside the function.

- # When Simul Graph is turned on, all of the graphs for the specified variable values are drawn simultaneously.
- # Overwrite can be used when graphing rectangular expressions, polar expressions, parametric functions, X = constant functions and inequalities.



## 5-7 Using Tables

### ■ Storing a Function and Generating a Number Table

- To store a function



**Example** To store the function  $y = 3x^2 - 2$  in memory area Y1

Use  $\blacktriangle$  and  $\blacktriangledown$  to move the highlighting in the Graph function list to the memory area where you want to store the function. Next, input the function and press  $\boxed{\text{EXE}}$  to store it.

- Variable Specifications

There are two methods you can use to specify value for the variable  $x$  when generating a numeric table.

- Table range method

With this method, you specify the conditions for the change in value of the variable.

- List

With this method, the data in the list you specify is substituted for the  $x$ -variable to generate a number table.

- To generate a table using a table range



**Example** To generate a table as the value of variable  $x$  changes from  $-3$  to  $3$ , in increments of  $1$

$\boxed{\text{F6}}$  ( $\triangleright$ )  $\boxed{\text{F2}}$  (RANG)  
 $\boxed{\leftarrow}$   $\boxed{3}$   $\boxed{\text{EXE}}$   $\boxed{3}$   $\boxed{\text{EXE}}$   $\boxed{1}$   $\boxed{\text{EXE}}$

```
Table Range
X
Start:-3
End :3
Pitch:1
```

The numeric table range defines the conditions under which the value of variable  $x$  changes during function calculation.

Start ..... Variable  $x$  start value

End ..... Variable  $x$  end value

pitch ..... Variable  $x$  value change (interval)

After specifying the table range, press  $\boxed{\text{ESC}}$  to return to the Graph function list.

• **To generate a table using a list**

1. While the Graph function list is on the screen, display the SET UP screen.
  2. Highlight Variable and then press **F2**(LIST) to display the pop-up window.
  3. Select the list whose values you want to assign for the  $x$ -variable.
    - To select List 6, for example, press **6** **EXE**. This causes the setting of the Variable item of the SET UP screen to change to List 6.
  4. After specifying the list you want to use, press **ESC** to return to the previous screen.
- Note that the {RANG} item does not appear when a list name is specified for the Variable item of the SET UP screen.



• **Generating a Table**



**Example** To generate a table of values for the functions stored in memory areas Y1 and Y3 of the Graph function list

Use **▲** and **▼** to move the highlighting to the function you want to select for table generation and press **F1**(SEL) to select it.

The “=” sign of selected functions is highlighted on the screen. To deselect a function, move the cursor to it and press **F1**(SEL) again.

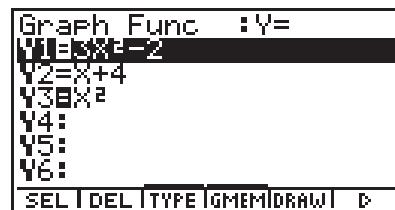

Press **F5**(TABL) to generate a number table using the functions you selected. The value of variable  $x$  changes according to the range or the contents of the list you specified.

The example screen shown here shows the results based on the contents of List 6 (−3, −2, −1, 0, 1, 2, 3).

| X  | Y1 | Y3 |
|----|----|----|
| -3 | 25 | 9  |
| -2 | 10 | 4  |
| -1 | 1  | 1  |
| 0  | -2 | 0  |

-3

EDIT | DEL | RE-TIG | CONIG | PLT | D |

Each cell can contain up to six digits, including negative sign.

You can use cursor keys to move the highlighting around the table for the following purposes.

- To display the selected cell's value at the bottom of the screen, using the calculator's current number of decimal place, number of significant digit, and exponential display range settings
- To scroll the display and view parts of the table that do not fit in the display
- To display at the top of the screen the scientific function that produced the value in the selected cell (in columns Y1, Y2, etc.)
- To change  $x$  variable values by replacing values in column X

Press  $\boxed{\text{ESC}}$  to return to the Graph function list.



### • To generate a differential number table \*1

Changing the setting of SET UP screen's Derivative item to On causes a number table that includes the derivative to be displayed whenever you generate a number table.

Locating the cursor at a differential coefficient displays "dy/dx" in the top line, which indicates differential.

| X  | Y1 | Y'1 | Y2  |
|----|----|-----|-----|
| -3 | 25 | -18 | 9   |
| -2 | 10 | -12 | 4   |
| -1 | 1  | -6  | 1   |
| 0  | -2 | 0   | 0   |
|    |    |     | -18 |

EDIT|DEL|RE-TIG|CONIG|PLT| D |

### • Specifying the function type

You can specify a function as being one of three types.\*2

- Rectangular coordinate (Y=)
- Polar coordinate ( $r =$ )
- Parametric (Param)

1. Press  $\boxed{\text{F3}}$  (TYPE) while the function list is on the screen.
2. Press the number key that corresponds to the function type you want to specify.



\*1 An error occurs if a graph for which a range is specified or an overwrite graph is included among the graph expressions.

\*2 The number table is generated only for the function type specified on the function list (Graph Func). You cannot generate a number table for a mixture of different function types.



## ■ Editing and Deleting Functions

### • To edit a function

• • • • •

**Example** To change the function in memory area Y1 from  $y = 3x^2 - 2$  to  $y = 3x^2 - 5$

Use  $\blacktriangle$  and  $\blacktriangledown$  to move the highlighting to the function you want to edit.

```
Graph Func : Y=
Y1=3X^2-2
```

Use  $\blacktriangleleft$  and  $\blacktriangleright$  to move the cursor to the location of the change.

$\blacktriangleright$   $\blacktriangleright$   $\blacktriangleright$   $\blacktriangleright$   $\blacktriangleright$   $\text{DEL}$   $\text{5}$

```
Graph Func : Y=
Y1=3X^2-5
```

$\text{EXE}$

```
Graph Func : Y=
Y1=3X^2-5
Y2=X+4
Y3:
```

$\text{F6}$  ( $\blacktriangleright$ )  $\text{F5}$  (TABL)

| X  | Y1 | Y3 |
|----|----|----|
| -3 | 22 | 9  |
| -2 | 7  | 4  |
| -1 | -2 | 1  |
| 0  | -5 | 0  |

-3

EDIT|DEL|RE-TIG|CONIG|PLT|  $\blacktriangleleft$

- The Function Link Feature automatically reflects any changes you make to functions in the GRPH • TBL Mode list, and DYNA Mode list.

### • To delete a function

1. Use  $\blacktriangle$  and  $\blacktriangledown$  to move the highlighting to the function you want to delete and then press  $\text{F2}$  (DEL) or  $\text{DEL}$ .
2. Press  $\text{EXE}$  (Yes) to delete the function or  $\text{ESC}$  (No) to abort the operation without deleting anything.

## ■ Editing Tables

You can use the table menu to perform any of the following operations once you generate a table.

- Change the values of variable  $x$
- Edit (delete, insert, and append) rows
- Delete a table and regenerate table
- Draw a connect type graph
- Draw a plot type graph

While the Table & Graph menu is on the display, press  $\boxed{F3}$  (TABL) to display the table menu.

- $\{\text{EDIT}\}$  ... {edit value of  $x$ -variable}
- $\{\text{DEL}\cdot\text{A}\}$  ... {delete table}
- $\{\text{Re}\cdot\text{T}\}$  ... {regenerate table from function}
- $\{\text{G}\cdot\text{CON}\}/\{\text{G}\cdot\text{PLT}\}$  ... {connected type}/{draw plot type} graph draw
- $\{\text{R}\cdot\text{DEL}\}/\{\text{R}\cdot\text{INS}\}/\{\text{R}\cdot\text{ADD}\}$  ... {delete}/{insert}/{add} row

### • To change variable values in a table

● ● ● ● ●

**Example** To change the value in Column  $x$ , Row 3 of the table generated on page 5-7-2 from  $-1$  to  $-2.5$



| $x$ | $y_1$ | $y_2$ |
|-----|-------|-------|
| -3  | 25    | 9     |
| -2  | 10    | 4     |
| -1  | 1     | 1     |
| 0   | -2    | 0     |

-1

EDIT|DEL·A|Re·T|G·CON|G·PLT|  $\boxed{D}$



| $x$  | $y_1$ | $y_2$ |
|------|-------|-------|
| -3   | 25    | 9     |
| -2   | 10    | 4     |
| -2.5 | 16.75 | 6.25  |
| 0    | -2    | 0     |

-2.5

EDIT|DEL·A|Re·T|G·CON|G·PLT|  $\boxed{D}$

- When you change a variable value in Column  $x$ , all values in the columns to the right are recalculated and displayed.



# If you try to replace a value with an illegal operation (such as division by zero), an error occurs and the original value remains unchanged.

# You cannot directly change any values in the other (non- $x$ ) columns of the table.

## • Row Operations

### • To delete a row

• • • • •

**Example** To delete Row 2 of the table generated on page 5-7-2



| X  | Y1 | Y2 |
|----|----|----|
| -3 | 25 | 9  |
| -2 | 10 | 4  |
| -1 | 1  | 1  |
| 0  | -2 | 0  |

-2

EDIT|DEL|R·T|G·COM|G·PLT| D

**F6**(▷)**F1**(R·DEL)

| X  | Y1 | Y2 |
|----|----|----|
| -3 | 25 | 9  |
| -1 | 1  | 1  |
| 0  | -2 | 0  |
| 1  | 1  | 1  |

-1

R·DEL|R·INS|R·ADD| D

### • To insert a row

• • • • •

**Example** To insert a new row between Rows 1 and 2 in the table generated on page 5-7-2



| X  | Y1 | Y2 |
|----|----|----|
| -3 | 25 | 9  |
| -2 | 10 | 4  |
| -1 | 1  | 1  |
| 0  | -2 | 0  |

-2

EDIT|DEL|R·T|G·COM|G·PLT| D

**F6**(▷)**F2**(R·INS)

| X  | Y1 | Y2 |
|----|----|----|
| -3 | 25 | 9  |
| -2 | 10 | 4  |
| -2 | 10 | 4  |
| -1 | 1  | 1  |

-2

R·DEL|R·INS|R·ADD| D

• To add a row

• • • • •

**Example** To add a new row below Row 7 in the table generated on page 5-7-2

⏴ ⏴ ⏴ ⏴ ⏴ ⏴

| X | Y1 | Y2 |
|---|----|----|
| 0 | -2 | 0  |
| 1 | 1  | 1  |
| 2 | 10 | 4  |
| 3 | 25 | 9  |

3

EDIT|DEL|RE-TIG-COM|G-PLT| D

F6 (▷) F3 (R-ADD)

| X | Y1 | Y2 |
|---|----|----|
| 1 | 1  | 1  |
| 2 | 10 | 4  |
| 3 | 25 | 9  |
| 3 | 25 | 9  |

3

R-DEL|R-INS|R-ADD D



• Deleting a Table

1. Display the table and then press F2 (DEL-A).
2. Press EXE (Yes) to delete the table or ESC (No) to abort the operation without deleting anything.

## ■ Copying a Table Column to a List

A simple operation lets you copy the contents of a numeric table column into a list.

### • To copy a table to a list



**Example** To copy the contents of Column  $x$  into List 1

**OPTN** **F1** (LMEM)



- You can select any row of the column you want to copy.

Input the number of the list you want to copy and then press **EXE**.

**1** **EXE**

| X  | Y1 | Y3 |
|----|----|----|
| -3 | 25 | 9  |
| -2 | 10 | 4  |
| -1 | 1  | 1  |
| 0  | -2 | 0  |

LMEM  $\leftarrow$  OPTN ENG  $\leftarrow$  ENG -3

## ■ Drawing a Graph from a Number Table

### Description

Use the following procedure to generate a number table and then draw a graph based on the values in the table.

### Set Up

1. From the Main Menu, enter the GRPH • TBL Mode.
2. Make V-Window settings.

### Execution

3. Store the functions.
4. Specify the table range.
5. Generate the table.
6. Select the graph type and draw it.
  - F4** (G • CON) ... line graph\*<sup>1</sup>
  - F5** (G • PLT) ... plot type graph\*<sup>1\*2</sup>



\*<sup>1</sup> After drawing the graph, pressing **CTRL** **F5** (G ↔ T) or **ESC** returns to the function storage screen. To return to the number table screen, press **F5** (TABL).

\*<sup>2</sup> Pressing **F6** (▷) **F4** (G • PLT) on the function storage screen generates the number table and plots the graph simultaneously.



**Example** Store the two functions below, generate a number table, and then draw a line graph. Specify a range of  $-3$  to  $3$ , and an increment of  $1$ .

$Y1 = 3x^2 - 2$ ,  $Y2 = x^2$

Use the following V-Window settings.

$Xmin = 0$ ,  $Xmax = 6$ ,  $Xscale = 1$

$Ymin = -2$ ,  $Ymax = 10$ ,  $Yscale = 2$

### Procedure

- ① **MENU** GRPH•TBL
- ② **SHIFT** **OPTN** (V-Window) **0** **EXE** **6** **EXE** **1** **EXE** **▼**  
**(←)** **2** **EXE** **1** **0** **EXE** **2** **EXE** **ESC**
- ③ **F3** (TYPE) **1** (Y=) **3** **X,θ,T** **x<sup>2</sup>** **-** **2** **EXE**  
**X,θ,T** **x<sup>2</sup>** **EXE**
- ④ **F6** (▷) **F2** (RANG) **(←)** **3** **EXE** **3** **EXE** **1** **EXE** **ESC**
- ⑤ **F5** (TABL)
- ⑥ **F4** (G•CON)

### Result Screen

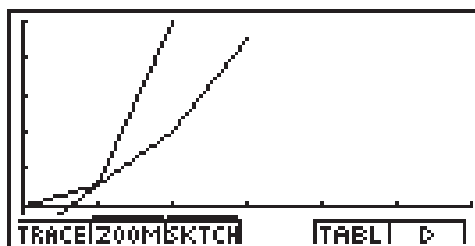

# You can use Trace, Zoom, or Sketch after drawing a graph.

---

## ■ Specifying a Range for Number Table Generation

### Description

Use the following procedure to specify a number table range when calculating scatter data from a function.

---

### Set Up

- 1. From the Main Menu, enter the GRPH•TBL Mode.

### Execution

- 2. Store the functions.
- 3. Specify the table range.
- 4. Select the functions for which you want to generate a table.  
The “=” sign of selected functions is highlighted on the screen.
- 5. Generate the table.







**Example** Store the three functions shown below, and then generate a table for functions Y1 and Y3. Specify a range of -3 to 3, and an increment of 1.

$Y1 = 3x^2 - 2$ ,  $Y2 = x + 4$ ,  $Y3 = x^2$

**Procedure**

- ① **MENU** GRPH•TBL
- ② **F3**(TYPE) **1** (Y=) **3** **X,θ,T** **x<sup>2</sup>** **-** **2** **EXE**  
**X,θ,T** **+** **4** **EXE**  
**X,θ,T** **x<sup>2</sup>** **EXE**
- ③ **F6** (▷) **F2** (RANG) (←) **3** **EXE** **3** **EXE** **1** **EXE** **ESC**
- ④ **▲** **▲** **F1** (SEL)
- ⑤ **F5** (TABL)

**Result Screen**

| X  | Y1 | Y3 |
|----|----|----|
| -3 | 25 | 9  |
| -2 | 10 | 4  |
| -1 | 1  | 1  |
| 0  | -2 | 0  |

-3

EDIT DEL AIRE-TIG-COMIG-PLT | ▷ |



# You can generate number tables from rectangular coordinate, polar coordinate, and parametric functions.

# You can include derivatives in generated number tables by specifying On for the Derivative item on the SET UP screen.

## ■ Simultaneously Displaying a Number Table and Graph

### Description

Specifying T+G for Dual Screen on the SET UP makes it possible to display a number table and graph at the same time.

### Set Up

1. From the Main Menu, enter the GRPH•TBL Mode.
2. Make V-Window settings.
3. On the SET UP screen, select T+G for Dual Screen.

### Execution

4. Input the function.
5. Specify the table range.
6. The number table is displayed in the sub-screen on the right.
7. Specify the graph type and draw the graph.
  - F4**(G•CON) ... line graph
  - F5**(G•PLT) ... plot type graph\*<sup>1</sup>



\*<sup>1</sup> Pressing **F6**(▷) **F4**(G•PLT) on the function storage screen generates the number table and plots the graph simultaneously.



**Example** Store the function  $Y1 = 3x^2 - 2$  and simultaneously display its number table and line graph. Use a table range of  $-3$  to  $3$  with an increment of  $1$ .

Use the following V-Window settings.

$Xmin = 0,$       $Xmax = 6,$       $Xscale = 1$

$Ymin = -2,$       $Ymax = 10,$       $Yscale = 2$

### Procedure

- ① **MENU** GRPH•TBL
- ② **SHIFT** **OPTN** (V-Window) **0** **EXE** **6** **EXE** **1** **EXE** **▼**  
**(←)** **2** **EXE** **1** **0** **EXE** **2** **EXE** **ESC**
- ③ **CTRL** **F3** (SET UP) **▼** **▼** **▼** **F1** (T+G) **ESC**
- ④ **F3** (TYPE) **1** (Y=) **3** **X,θ,T** **x<sup>2</sup>** **-** **2** **EXE**
- ⑤ **F6** (▷) **F2** (RANG)  
**(←)** **3** **EXE** **3** **EXE** **1** **EXE** **ESC**
- ⑥ **F5** (TABL)
- ⑦ **F4** (G•CON)

### Result Screen

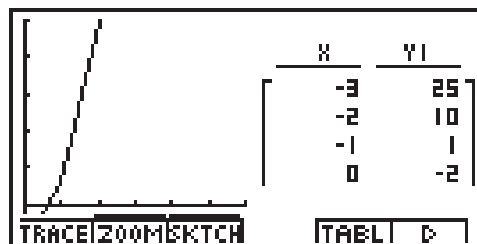

## ■ Using Graph-Table Linking





### Description

With Dual Graph, you can use the following procedure to link the graph and table screens so the pointer on the graph screen jumps to the location of the currently selected table value.

### Set Up

1. From the Main Menu, enter the GRPH•TBL Mode.
2. Make the required V-Window settings.  
Display the SET UP screen, select the Dual Screen item, and change its setting to "T+G".

### Execution

3. Input the function of the graph and make the required table range settings.
4. With the number table on the right side of the display, draw the graph on the left side.  
**F4**(G•CON) ... connect type graph  
**F5**(G•PLT) ... plot type graph
5. Turn on G•Link.
6. Now when you use  and  to move the highlighting among the cells in the table, the pointer jumps to the corresponding point on the graph screen.  
If there are multiple graphs, pressing  and  causes the pointer to jump between them.

To turn off G•Link, press **ESC** or **SHIFT** **ESC** (QUIT).





**Example** Store the function  $Y1 = 3\log x$  and simultaneously display its number table and plot-type graph. Use a table range of 2 through 9, with an increment of 1.

Use the following V-Window settings.

Xmin = -1, Xmax = 10, Xscale = 1

Ymin = -1, Ymax = 4, Yscale = 1

### Procedure

- ① **MENU** GRPH•TBL
- ② **SHIFT** **OPTN** (V-Window) **(←)** **1** **EXE** **1** **0** **EXE** **1** **EXE** **(▼)**  
**(←)** **1** **EXE** **4** **EXE** **1** **EXE** **ESC**  
**CTRL** **F3** (SET UP) **(▼)** **(▼)** **(▼)** **F1** (T+G) **ESC**
- ③ **F3** (TYPE) **1** (Y=) **3** **log** **X,θ,T** **EXE**  
**F6** (▷) **F2** (RANG)  
**2** **EXE** **9** **EXE** **1** **EXE** **ESC**
- ④ **F5** (TABL)  
**F5** (G•PLT)
- ⑤ **F6** (▷) **F4** (G•Link)
- ⑥ **(▼)** ~ **(▼)**, **(▲)** ~ **(▲)**

### Result Screen

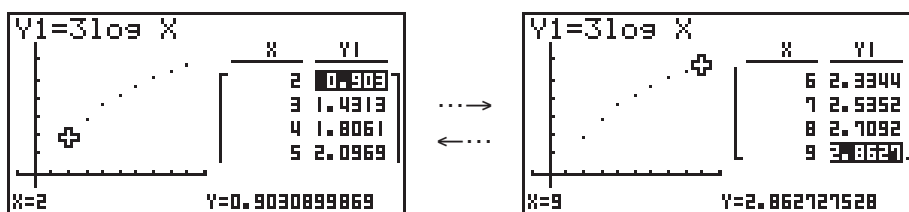

## 5-8 Dynamic Graphing

### ■ Using Dynamic Graph

#### Description

Dynamic Graph lets you define a range of values for the coefficients in a function, and then observe how a graph is affected by changes in the value of a coefficient. It helps to see how the coefficients and terms that make up a function influence the shape and position of a graph.

#### Set Up

1. From the Main Menu, enter the DYNA Mode.
2. Make V-Window settings.

#### Execution

3. On the SET UP screen, specify the Dynamic Type.
  - F1**(Cont) ... Continuous
  - F2**(Stop) ... Automatic stop after 10 draws
4. Use the cursor keys to select the function type on the built-in function type list.\*1
5. Input values for coefficients, and specify which coefficient will be the dynamic variable.\*2
6. Specify the start value, end value, and increment.
7. Specify the drawing speed.
  - F3**(SPEED) **F1**(|||) ..... Pause after each draw (Stop & Go)
  - F2**(>) ..... Half normal speed (Slow)
  - F3**(|) ..... Normal speed (Normal)
  - F4**(>>) ..... Twice normal speed (Fast)
8. Draw the Dynamic Graph.



\*1 The following are the seven built-in function types.

- $Y=AX+B$
- $Y=A(X-B)^2+C$
- $Y=AX^2+BX+C$
- $Y=AX^3+BX^2+CX+D$
- $Y=A\sin(BX+C)$
- $Y=A\cos(BX+C)$
- $Y=A\tan(BX+C)$

After you press **F3**(TYPE) and select the function type you want, you can then input the actual function.

- 1** ... rectangular coordinate expression
- 2** ... polar coordinate expression
- 3** ... parametric function

\*2 You could also press **EXE** here and display the parameter setting menu.

# The message "Too Many Functions" appears when more than one function is selected for Dynamic Graphing.





**Example** Use Dynamic Graph to graph  $y = A(x - 1)^2 - 1$ , in which the value of coefficient  $A$  changes from 2 through 5 in increments of 1. The Graph is drawn 10 times.

Use the following V-Window settings.

$X_{min} = -6.3$ ,  $X_{max} = 6.3$ ,  $X_{scale} = 1$

$Y_{min} = -3.1$ ,  $Y_{max} = 3.1$ ,  $Y_{scale} = 1$  (initial defaults)

### Procedure

- ① **MENU** DYNA
- ② **SHIFT** **OPTN** (V-Window) **F1** (INIT) **ESC**
- ③ **CTRL** **F3** (SET UP) **F2** (Stop) **ESC**
- ④ **F6** ( $\triangleright$ ) **F3** (B-IN)  $\blacktriangledown$  **F1** (SEL)
- ⑤ **F6** ( $\triangleright$ ) **F4** (VAR) **2** **EXE** **1** **EXE** ( $\leftarrow$ ) **1** **EXE**
- ⑥ **F2** (RANG) **2** **EXE** **5** **EXE** **1** **EXE** **ESC**
- ⑦ **F3** (SPEED) **F3** ( $\blacktriangleright$ ) **ESC**
- ⑧ **F6** (DYNA)

### Result Screen



Repeats from ① through ④.

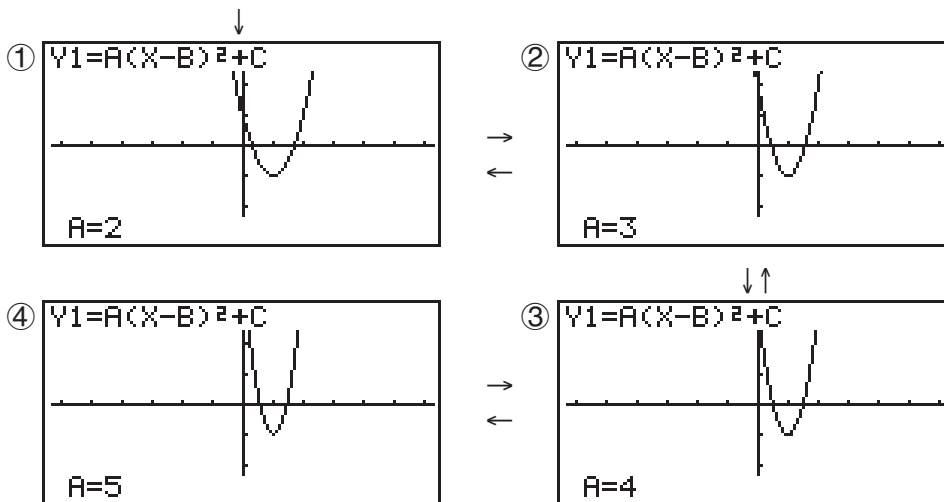

---

## ■ Dynamic Graph Application Examples

### Description

You can also use Dynamic Graph to simulate simple physical phenomena.

---

### Set Up

1. From the Main Menu, enter the DYNA Mode.
2. Make V-Window settings.

### Execution

3. On the SET UP screen, specify Stop for Dynamic Type and Deg for Angle.
4. Specify Param (parametric function) as the function type, and input a function that contains a dynamic variable.
5. Specify the dynamic coefficient.
6. Specify the start value, end value, and increment.
7. Specify Normal for the draw speed.
8. Start the Dynamic Graph operation.





•••••  
**Example**

The path over time  $T$  of a ball thrown in the air at initial velocity  $V$  and an angle of  $\theta$  degrees from horizontal can be calculated as follows.

$$X = (V \cos \theta)T, \quad Y = (V \sin \theta)T - (1/2)gT^2 \quad (g = 9.8\text{m/s}^2)$$

Use Dynamic Graph to plot the path of a ball thrown at an initial velocity of 20 meters per second, at horizontal angles of 30, 45, and 60 degrees (Angle: Deg).

Use the following V-Window settings.

$$X_{\min} = -1, \quad X_{\max} = 42, \quad X_{\text{scale}} = 5$$

$$Y_{\min} = -1, \quad Y_{\max} = 16, \quad Y_{\text{scale}} = 2$$



**Procedure**

- ① **MENU** DYNA
- ② **SHIFT OPTN** (V-Window) **(←) 1 EXE 4 2 EXE 5 EXE (▼)**  
**(←) 1 EXE 1 6 EXE 2 EXE ESC**
- ③ **CTRL F3** (SET UP) **F2** (Stop)  
**(▼) (▼) (▼) (▼) F1** (Deg) **ESC**
- ④ **F3** (TYPE) **3** (Param)  
**(←) 2 0 cos ALPHA X,θ,T (A) (→) X,θ,T EXE**  
**(←) 2 0 sin ALPHA X,θ,T (A) (→) X,θ,T = 4 . 9 X,θ,T x² EXE**
- ⑤ **F4** (VAR)
- ⑥ **F2** (RANG) **3 0 EXE 6 0 EXE 1 5 EXE ESC**
- ⑦ **F3** (SPEED) **F3** (▶) **ESC**
- ⑧ **F6** (DYNA)

**Result Screen**



## ■ Adjusting the Dynamic Graph Speed

You can use the following procedure to adjust the Dynamic Graph speed while the draw operation is taking place.

1. While a Dynamic Graph draw operation is being performed, press **AC** to change to the speed adjustment menu.

```
f1=(20cos A)T,(20sin
Dynamic Range
A
Start:30
End :60
Pitch:15
|||> | > | F | >> | STO |
```

- **{|||>}** ... {Each step of the Dynamic Graph draw operation is performed each time you press **EXE** .}
  - **{>}/**{F}**/**{>>}**** ... {slow (1/2 speed)}/{normal (default speed)}/{fast (double speed)}
  - **{STO}** ... {stores graph conditions and screen data in Dynamic Graph memory}
2. Press the function key (**F1** to **F4**) that corresponds to the speed you want to change to.



# To clear the speed adjustment menu without changing anything, press **EXE** .

# Press **CTRL F5** (**G↔T**) to return to the graph screen.

## ■ Using Dynamic Graph Memory

You can store Dynamic Graph conditions and screen data in Dynamic Graph memory for later recall when you need it. This lets you save time, because you can recall the data and immediately begin a Dynamic Graph draw operation. Note that you can store one set of data in memory at any one time.

The following is all of the data that makes up a set.

- Graph functions (up to 20)
- Dynamic Graph conditions
- SET UP screen settings
- V-Window contents
- Dynamic Graph screen

### ● To save data in Dynamic Graph memory

1. While a Dynamic Graph draw operation is being performed, press **AC** to change to the speed adjustment menu.
2. Press **F5** (STO). In response to the confirmation dialog that appears, press **EXE** (Yes) to save the data.

### ● To recall data from Dynamic Graph memory

1. Display the Dynamic Graph function list.
2. Press **F6** (RCL) to recall all the data stored in Dynamic Graph memory.



# If there is already data stored in Dynamic Graph memory, the data save operation replaces it with the new data.

# Data recalled from Dynamic Graph memory replaces the calculator's current graph functions, draw conditions, and screen data. The previous data is lost when it is replaced.

## 5-9 Graphing a Recursion Formula

### ■ Generating a Number Table from a Recursion Formula

#### Description

You can input up to three of the following types of recursion formulas and generate a number table.

- General term of sequence  $\{a_n\}$ , composed of  $a_n, n$
- Linear two-term recursion composed of  $a_{n+1}, a_n, n$
- Linear three-term recursion composed of  $a_{n+2}, a_{n+1}, a_n, n$

#### Set Up

1. From the Main Menu, enter the RECUR Mode.

#### Execution

2. Specify the recursion type.

**F3**(TYPE) **1** ( $a_n=$ ) ... {general term of sequence  $a_n$ }

**2** ( $a_{n+1}= $\right.$ ) ... {linear two-term recursion}$

**3** ( $a_{n+2}= $\right.$ ) ... {linear three-term recursion}$

3. Input the recursion formula.
4. Specify the table range. Specify a start point and end point for  $n$ . If necessary, specify a value for the initial term, and a pointer start point value if you plan to graph the formula.
5. Display the recursion formula number table.





**Example** Generate a number table from recursion between three terms as expressed by  $a_{n+2} = a_{n+1} + a_n$ , with initial terms of  $a_1 = 1$ ,  $a_2 = 1$  (Fibonacci sequence), as  $n$  changes in value from 1 to 6.

### Procedure

- ① **MENU** RECUR
- ② **F3** (TYPE) **3** ( $a_{n+2} =$ )
- ③ **F4** ( $n, a_n \dots$ ) **3** ( $a_{n+1}$ ) **+** **F2** ( $a_n$ ) **EXE**
- ④ **F5** (RANG) **F2** ( $a_1$ ) **1** **EXE** **6** **EXE** **1** **EXE** **1** **EXE** **ESC**
- ⑤ **F6** (TABL)

### Result Screen

| $n+2$ | $a_{n+2}$ |
|-------|-----------|
| 1     | 1         |
| 2     | 1         |
| 3     | 2         |
| 4     | 3         |

1

RE-T|DEL-A      G·CON|G·PLT



# Specifying On for the  $\Sigma$  Display of the SET UP screen causes the sum of each term to be included in the table.

---

## ■ Graphing a Recursion Formula (1)

### Description

After generating a number table from a recursion formula, you can graph the values on a line graph or plot type graph.

---

### Set Up

1. From the Main Menu, enter the RECUR Mode.
2. Make V-Window settings.

### Execution

3. Specify the recursion formula type and input the formula.
4. Specify the table range, and start and ending values for  $n$ . If necessary, specify the initial term value and pointer start point.
5. Display the recursion formula number table.
6. Specify the graph type and draw the graph.
  - F5**(G•CON) ... line graph
  - F6**(G•PLT) ... plot type graph





**Example** Generate a number table from recursion between two terms as expressed by  $a_{n+1} = 2a_n + 1$ , with an initial term of  $a_1 = 1$ , as  $n$  changes in value from 1 to 6. Use the table values to draw a line graph.

Use the following V-Window settings.

Xmin = 0, Xmax = 6, Xscale = 1

Ymin = -15, Ymax = 65, Yscale = 5

### Procedure

- ① **MENU** RECUR
- ② **SHIFT** **OPTN** (V-Window) **0** **EXE** **6** **EXE** **1** **EXE** **▼**  
**(-)** **1** **5** **EXE** **6** **5** **EXE** **5** **EXE** **ESC**
- ③ **F3** (TYPE) **2** ( $a_{n+1} =$ ) **2** **F2** ( $a_n$ ) **+** **1** **EXE**
- ④ **F5** (RANG) **F2** ( $a_1$ ) **1** **EXE** **6** **EXE** **1** **EXE** **ESC**
- ⑤ **F6** (TABL)
- ⑥ **F5** (G • CON)

### Result Screen

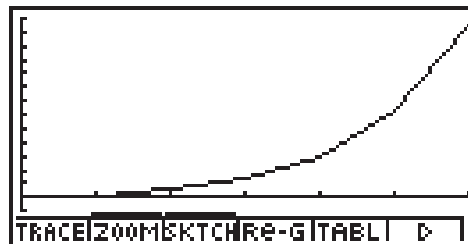

## ■ Graphing a Recursion Formula (2)

### Description

The following describes how to generate a number table from a recursion formula and graph the values while  $\Sigma$  Display is On.

### Set Up

1. From the Main Menu, enter the RECUR Mode.
2. On the SET UP screen, specify On for  $\Sigma$  Display.
3. Make V-Window settings.

### Execution

4. Specify the recursion formula type and input the recursion formula.
5. Specify the table range, and start and ending values for  $n$ . If necessary, specify the initial term value and pointer start point.
6. Display the recursion formula number table.
7. Specify the graph type and draw the graph.
  - F5**(G•CON) **1**( $a_n$ ) ... Line graph with ordinate  $a_n$ , abscissa  $n$
  - 2**( $\Sigma a_n$ ) ... Line graph with ordinate  $\Sigma a_n$ , abscissa  $n$
  - F6**(G•PLT) **1**( $a_n$ ) ... Plot type graph with ordinate  $a_n$ , abscissa  $n$
  - 2**( $\Sigma a_n$ ) ... Plot type graph with ordinate  $\Sigma a_n$ , abscissa  $n$





● ● ● ● ●  
**Example**

Generate a number table from recursion between two terms as expressed by  $a_{n+1} = 2a_n + 1$ , with an initial term of  $a_1 = 1$ , as  $n$  changes in value from 1 to 6. Use the table values to draw a plot line graph with ordinate  $\Sigma a_n$ , abscissa  $n$ .

Use the following V-Window settings.

Xmin = 0,    Xmax = 6,    Xscale = 1

Ymin = -15,    Ymax = 65,    Yscale = 5

### Procedure

- ① **MENU** RECUR
- ② **CTRL** **F3** (SET UP) **F1** (On) **ESC**
- ③ **SHIFT** **OPTN** (V-Window) **0** **EXE** **6** **EXE** **1** **EXE** **▼**  
**(←)** **1** **5** **EXE** **6** **5** **EXE** **5** **EXE** **ESC**
- ④ **F3** (TYPE) **2** ( $a_{n+1} =$ ) **2** **F2** ( $a_n$ ) **+** **1** **EXE**
- ⑤ **F5** (RANG) **F2** ( $a_1$ ) **1** **EXE** **6** **EXE** **1** **EXE** **ESC**
- ⑥ **F6** (TABL)
- ⑦ **F6** (G•PLT) **2** ( $\Sigma a_n$ )

### Result Screen

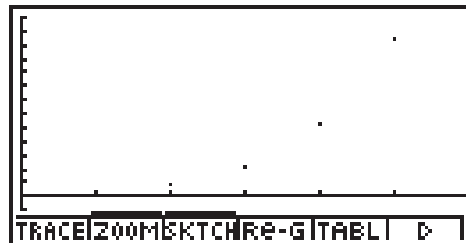

## ■ WEB Graph (Convergence, Divergence)

### Description

$y = f(x)$  is graphed by presuming  $a_{n+1} = y$ ,  $a_n = x$  for linear two-term recursion  $a_{n+1} = f(a_n)$  composed of  $a_{n+1}$ ,  $a_n$ . Next, it can be determined whether the function is convergent or divergent.

### Set Up

1. From the Main Menu, enter the RECUR Mode.
2. Make V-Window settings.

### Execution

3. Select 2-term recursion as the recursion formula type, and input the formula.
4. Specify the table range,  $n$  start and end points, initial term value, and pointer start point.
5. Display the recursion formula number table.
6. Draw the graph.
7. Press  $\boxed{\text{EXE}}$ , and the pointer appears at the start point you specified.  
Press  $\boxed{\text{EXE}}$  several times.

If convergence exists, lines that resemble a spider web are drawn on the display. Failure of the web lines to appear indicates either divergence or that the graph is outside the boundaries of the display screen. When this happens, change to larger View Window values and try again.

You can use  $\blacktriangle$   $\blacktriangledown$  to select the graph.



● ● ● ● ●  
**Example**

To draw the WEB graph for the recursion formula  $a_{n+1} = -3(a_n)^2 + 3a_n$ ,  $b_{n+1} = 3b_n + 0.2$ , and check for divergence or convergence. Use the following table range and V-Window Settings.

Table Range

Start = 0, End = 6,  $a_0 = 0.01$ ,  $a_n \text{Str} = 0.01$ ,  $b_0 = 0.11$ ,  $b_n \text{Str} = 0.11$

V-Window Settings

Xmin = 0, Xmax = 1, Xscale = 1

Ymin = 0, Ymax = 1, Yscale = 1

---

**Procedure**

- ① **MENU** RECUR
- ② **SHIFT** **OPTN** (V-Window) **0** **EXE** **1** **EXE** **1** **EXE** **▼**  
**0** **EXE** **1** **EXE** **1** **EXE** **ESC**
- ③ **F3** (TYPE) **2** ( $a_{n+1} =$ ) **(←)** **3** **F2** ( $a_n$ )  **$x^2$**  **+** **3** **F2** ( $a_n$ ) **EXE**  
**3** **F3** ( $b_n$ ) **+** **0** **.** **2** **EXE**
- ④ **F5** (RANG) **F1** ( $a_0$ )  
**0** **EXE** **6** **EXE** **0** **.** **0** **1** **EXE** **0** **.** **1** **1** **EXE** **▼**  
**0** **.** **0** **1** **EXE** **0** **.** **1** **1** **EXE** **ESC**
- ⑤ **F6** (TABL)
- ⑥ **F4** (WEB)
- ⑦ **F1** (TRACE) **EXE** **~** **EXE** ( $a_n$  is convergence)  
**▼** **EXE** **~** **EXE** ( $b_n$  is divergence)

---

**Result Screen**

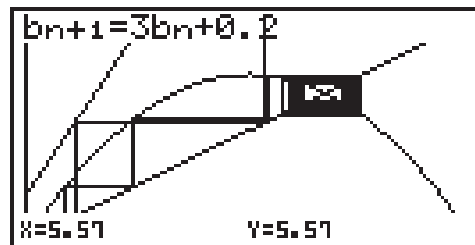

## 5-10 Changing the Appearance of a Graph

### ■ Drawing a Line

#### Description

The sketch function lets you draw points and lines inside of graphs.

#### Set Up

1. Draw the graph.

#### Execution

2. Select the sketch function you want to use.\*<sup>1</sup>

- F3** (SKTCH) **1** (Cls) ... Screen clear
- 2** (PLOT)  
     {On}/{Off}/{Change}/{Plot} ... Point {On}/{Off}/{Change}/{Plot}
- 3** (LINE)  
     {F-Line}/{Line} ... {Freehand line}/{Line}
- 4** (Text) ... Text input
- 5** (Pen) ... Freehand
- 6** (Tangnt) ... Tangent line
- 7** (Normal) ... Line normal to a curve
- 8** (Invrse) ... Inverse function\*<sup>2</sup>
- 9** (Circle) ... Circle
- X,θ,T** (Vert) ... Vertical line
- log** (Horz) ... Horizontal line

3. Use the cursor keys to move the pointer (⤠) to the location where you want to draw, and press **EXE**.\*<sup>3</sup>



\*<sup>1</sup>The above shows the function menu that appears in the GRPH•TBL Mode. Menu items may differ somewhat in other modes.

\*<sup>2</sup>In the case of an inverse function graph, drawing starts immediately after you select this option.

\*<sup>3</sup>Some sketch functions require specification of two points. After you press **EXE** to specify the first point, use the cursor keys to move the pointer to the location of the second point and press **EXE**.





**Example** Draw a line that is tangent to point (2, 0) on the graph for  $y = x(x + 2)(x - 2)$ .

Use the following V-Window settings.

**Xmin = -5, Xmax = 5, Xscale = 1**

**Ymin = -5, Ymax = 5, Yscale = 1**

### Procedure

- ① **MENU** GRPH•TBL  
**SHIFT** **OPTN** (V-Window) **(←)** **5** **EXE** **5** **EXE** **1** **EXE** **▼**  
**(←)** **5** **EXE** **5** **EXE** **1** **EXE** **ESC**  
**F3** (TYPE) **1** (Y=) **(X,θ,T)** **(←)** **(X,θ,T)** **+** **2** **)** **(←)** **(X,θ,T)** **-** **2** **)** **EXE**  
**F5** (DRAW)
- ② **F3** (SKTCH) **6** (Tangnt)
- ③ **▶** ~ **▶** **EXE** \*1

### Result Screen

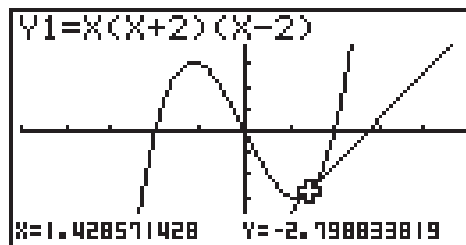

\*1 You can draw a tangent line in succession by moving the "⊕" pointer and pressing **EXE**.

## ■ Inserting Comments

### Description

You can insert comments anywhere you want in a graph.

### Set Up

- 1. Draw the graph.

### Execution

- 2. Press **F3** (SKTCH) **4** (Text), and a pointer appears in the center of the display.
- 3. Use the cursor keys to move the pointer to the location where you want the text to be, and input the text.



# You can input any of the following characters as comment text: A~Z,  $r$ ,  $\theta$ , space, 0~9, ., +, -,  $\times$ ,  $\div$ , (-), EXP,  $\pi$ , Ans, (, ), [, ], {, }, comma,  $\rightarrow$ ,  $x^2$ ,  $\wedge$ , log, ln,  $\sqrt{\quad}$ ,  $\sqrt[x]{\quad}$ ,  $10^x$ ,  $e^x$ ,  $\sqrt[3]{\quad}$ ,  $x^{-1}$ , sin, cos, tan,  $\sin^{-1}$ ,  $\cos^{-1}$ ,  $\tan^{-1}$ ,  $i$ , List, Mat



**Example** Insert text into the graph  $y = x(x + 2)(x - 2)$ .

Use the following V-Window settings.

**Xmin = -5, Xmax = 5, Xscale = 1**

**Ymin = -5, Ymax = 5, Yscale = 1**

### Procedure

- ① **MENU** GRPH•TBL  
**SHIFT** **OPTN** (V-Window) **(←)** **5** **EXE** **5** **EXE** **1** **EXE** **▼**  
**(←)** **5** **EXE** **5** **EXE** **1** **EXE** **ESC**  
**F3** (TYPE) **1** (Y=) **(X,θ,T)** **(←)** **(X,θ,T)** **+** **2** **)** **(←)** **(X,θ,T)** **-** **2** **)** **EXE**  
**F5** (DRAW)
- ② **F3** (SKTCH) **4** (Text)
- ③ **▲** **▼** **▶** **▶**  
**ALPHA** **=** (Y) **SHIFT** **□** (=) **(X,θ,T)** **(←)** **(X,θ,T)** **+** **2** **)** **(←)** **(X,θ,T)** **-** **2** **)**  
**ESC**

### Result Screen

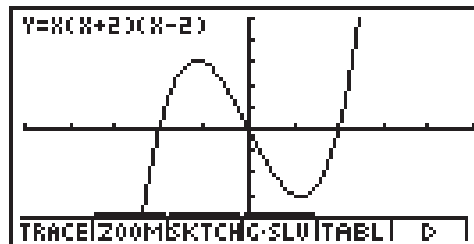

---

## ■ Freehand Drawing

### Description

You can use the pen option for freehand drawing in a graph.

---

### Set Up

- 1. Draw the graph.

### Execution

- 2. Press **F3** (SKTCH) **F5** (Pen), and a pointer appears in the center of the screen.
- 3. Use the cursor keys to move the pointer to the point from which you want to start drawing, and then press **EXE**.
- 4. Use the cursor keys to move the pointer. A line is drawn wherever you move the pointer. To stop the line, press **EXE**.  
Repeat step 3 and 4 to draw other lines.  
After you are finished drawing, press **ESC**.







**Example** Use the pen to draw on the graph  $y = x(x + 2)(x - 2)$ .

Use the following V-Window settings.

**Xmin = -5, Xmax = 5, Xscale = 1**

**Ymin = -5, Ymax = 5, Yscale = 1**

### Procedure

① **MENU** GRPH•TBL

**SHIFT** **OPTN** (V-Window) **(←)** **5** **EXE** **5** **EXE** **1** **EXE** **(↓)**

**(←)** **5** **EXE** **5** **EXE** **1** **EXE** **ESC**

**F3** (TYPE) **1** (Y=) **(X,θ,T)** **(←)** **(X,θ,T)** **+** **2** **)** **(←)** **(X,θ,T)** **-** **2** **)** **EXE**

**F5** (DRAW)

② **F3** (SKTCH) **5** (Pen)

③ **(↑)** **(↓)** **(→)** **(→)** **EXE**

④ **(↑)** **(↓)** **(→)** **(→)** **EXE**

### Result Screen

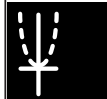
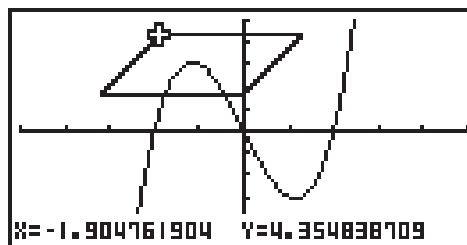

## ■ Changing the Graph Background

You can use the set up screen to specify the memory contents of any picture memory area (Pict 1 through Pict 20) as the Background item. When you do, the contents of the corresponding memory area is used as the background of the graph screen.



**Example 1** With the circle graph  $X^2 + Y^2 = 1$  as the background, use Dynamic Graph to graph  $Y = X^2 + A$  as variable  $A$  changes value from  $-1$  to  $1$  in increments of  $1$ .

Recall the background graph.

$$(X^2 + Y^2 = 1)$$

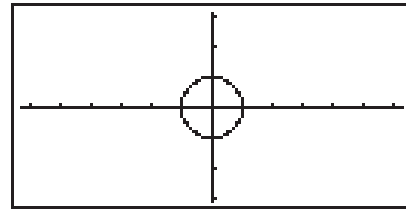

Draw the dynamic graph.

$$(Y = X^2 - 1)$$

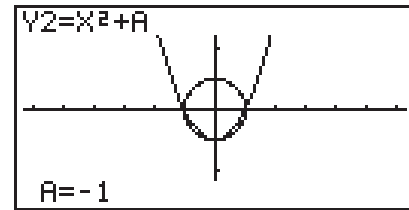

$$(Y = X^2)$$

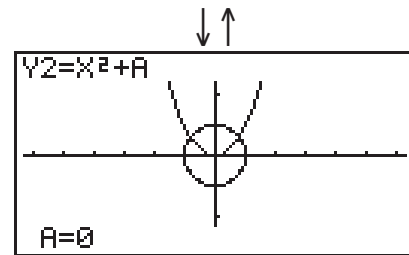

$$(Y = X^2 + 1)$$

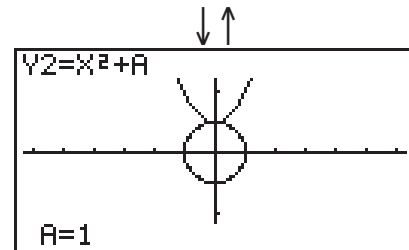

- See “5-8-1 Dynamic Graphing” for details on using the Dynamic Graph feature.

## 5-11 Function Analysis

### ■ Reading Coordinates on a Graph Line

#### Description

Trace lets you move a pointer along a graph and read out coordinates on the display.

#### Set Up

1. Draw the graph.

#### Execution

2. Press **[F1]** (TRACE), and a pointer appears in the center of the graph.\*<sup>1</sup>
3. Use **◀** and **▶** to move the pointer along the graph to the point at which you want to display the derivative.  
When there are multiple graphs on the display, press **▲** and **▼** to move between them along the  $x$ -axis of the current pointer location.
4. You can also move the pointer by pressing **[X,θ,T]** to display the pop up window, and then inputting coordinates.

To exit a trace operation, press **[ESC]**.



\*<sup>1</sup>The pointer is not visible on the graph when it is located at point outside the graph display area or when an error no value occurs.

# You can turn off display of the coordinates at the pointer location by specifying “Off” for the “Coord” item on the SET UP screen.



**Example** Read coordinates along the graph of the function shown below.

$$Y1 = x^2 - 3$$

Use the following V-Window settings.

$$Xmin = -5, \quad Xmax = 5, \quad Xscale = 1$$

$$Ymin = -10, \quad Ymax = 10, \quad Yscale = 2$$

### Procedure

- ① **MENU** GRPH•TBL  
**SHIFT** **OPTN** (V-Window) **(←)** **5** **EXE** **5** **EXE** **1** **EXE** **▼**  
**(←)** **1** **0** **EXE** **1** **0** **EXE** **2** **EXE** **ESC**  
**F3** (TYPE) **1** (Y=) **X,θ,T** **x<sup>2</sup>** **-** **3** **EXE**  
**F5** (DRAW)
- ② **F1** (TRACE)
- ③ **←** ~ **←**
- ④ **X,θ,T** **(←)** **1** **EXE**

### Result Screen

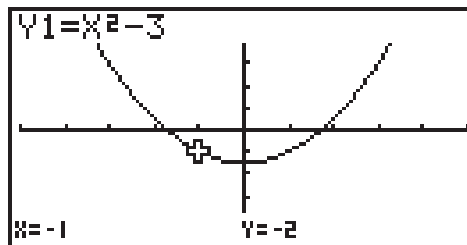
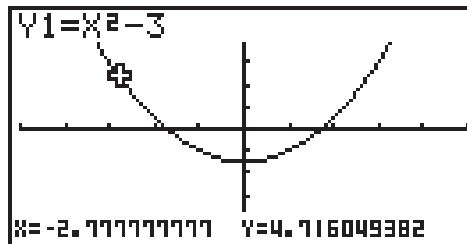

# The following shows how coordinates are displayed for each function type.

• **Polar Coordinate Graph**

**r** = 1.7320508075    **θ** = 0.34906585039

• **Parametric Graph**

**T** = 0.78539816339  
**X** = 6.7975065333    **Y** = 4.1843806035

• **Inequality Graph**

**X** = 1    **Y** < -7



---

## ■ Displaying the Derivative

### Description

In addition to using Trace to display coordinates, you can also display the derivative at the current pointer location.

---

### Set Up

1. On the SET UP screen, specify On for Derivative.
2. Draw the graph.

### Execution

3. Press **[F1]** (TRACE), and the pointer appears at the center of the graph. The current coordinates and the derivative also appear on the display at this time.
4. Use **◀** and **▶** to move the pointer along the graph to the point at which you want to display the derivative.  
When there are multiple graphs on the display, press **▲** and **▼** to move between them along the  $x$ -axis of the current pointer location.
5. You can also move the pointer by pressing **[X,θ,T]** to display the pop up window, and then inputting coordinates.





**Example** Read coordinates and derivatives along the graph of the function shown below.

$$Y1 = x^2 - 3$$

Use the following V-Window settings.

$$Xmin = -5, \quad Xmax = 5, \quad Xscale = 1$$

$$Ymin = -10, \quad Ymax = 10, \quad Yscale = 2$$

### Procedure

- ① **MENU** GRPH•TBL  
**CTRL** **F3** (SET UP) **▼** **▼** **▼** **▼** **▼** **F1** (On) **ESC**
- ② **SHIFT** **OPTN** (V-Window) **(←)** **5** **EXE** **5** **EXE** **1** **EXE** **▼**  
**(←)** **1** **0** **EXE** **1** **0** **EXE** **2** **EXE** **ESC**
- F3** (TYPE) **1** (Y=) **X,θ,T** **x<sup>2</sup>** **-** **3** **EXE**
- F5** (DRAW)
- ③ **F1** (TRACE)
- ④ **◀** ~ **▶**
- ⑤ **X,θ,T** **(←)** **1** **EXE**

### Result Screen

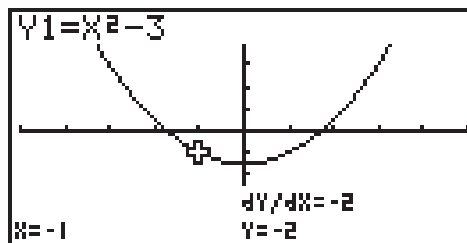
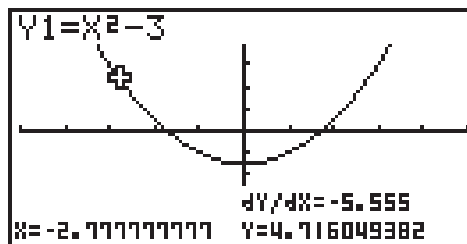

---

## ■ Graph to Table

### Description

You can use trace to read the coordinates of a graph and store them in a number table. You can also use Dual Graph to simultaneously store the graph and number table, making this an important graph analysis tool.

---

### Set Up

1. From the Main Menu, enter the GRPH•TBL Mode.
2. On the SET UP screen, specify GtoT for Dual Screen.
3. Make V-Window settings.

### Execution

4. Save the function and draw the graph on the active (left) screen.
5. Activate Trace. When there are multiple graphs on the display, press  $\blacktriangle$  and  $\blacktriangledown$  to select the graph you want.
6. Use  $\blacktriangleleft$  to move the pointer and press  $\boxed{\text{EXE}}$  to store coordinates into the number table. Repeat this step to store as many values as you want.
7. Press  $\boxed{\text{F6}}$  (CHNG) to switch the number table side.
8. From the pop-up window, input the list number you want to save.







**Example** Save in a table the coordinates in the vicinity of the points of intersection at  $X = 0$  for the two graphs shown below, and store the table contents in List 1.

$$Y1 = x^2 - 3, Y2 = -x + 2$$

Use the following V-Window settings.

$$Xmin = -5, Xmax = 5, Xscale = 1$$

$$Ymin = -10, Ymax = 10, Yscale = 2$$

### Procedure

- ① **MENU** GRPH•TBL
- ② **CTRL** **F3** (SET UP) **▼** **▼** **▼** **F3** (GtoT) **ESC**
- ③ **SHIFT** **OPTN** (V-Window) **(←)** **5** **EXE** **5** **EXE** **1** **EXE** **▼**  
**(←)** **1** **0** **EXE** **1** **0** **EXE** **2** **EXE** **ESC**
- ④ **F3** (TYPE) **1** (Y=) **X,θ,T** **x<sup>2</sup>** **-** **3** **EXE**  
**(←)** **X,θ,T** **+** **2** **EXE**
- F5** (DRAW)
- ⑤ **F1** (TRACE)
- ⑥ **◀** ~ **◀** **EXE** **▶** ~ **▶** **EXE** **ESC**
- ⑦ **F6** (CHNG)
- ⑧ **OPTN** **F1** (LMEM) **1** **EXE**

### Result Screen

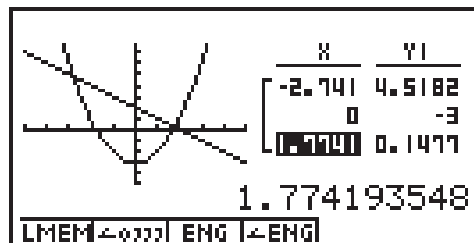

---

## ■ Coordinate Rounding

### Description

This function rounds off coordinate values displayed by Trace.

---

### Set Up

- 1. Draw the graph.

### Execution

- 2. Press **[F2]** (ZOOM) **[8]** (Rnd). This causes the V-Window settings to be changed automatically in accordance with the Rnd value.
- 3. Press **[F1]** (TRACE), and then use the cursor keys to move the pointer along the graph. The coordinates that now appear are rounded.



● ● ● ● ●  
**Example**

Use coordinate rounding and display the coordinates in the vicinity of the points of intersection for the two graphs produced by the functions shown below.

$$Y1 = x^2 - 3, Y2 = -x + 2$$

Use the following V-Window settings.

$$Xmin = -5, \quad Xmax = 5, \quad Xscale = 1$$

$$Ymin = -10, \quad Ymax = 10, \quad Yscale = 2$$

**Procedure**

- ① **MENU** GRPH•TBL  
 $\text{SHIFT}$   $\text{OPTN}$  (V-Window)  $\leftarrow$  **5** **EXE** **5** **EXE** **1** **EXE**  $\nabla$   
 $\leftarrow$  **1** **0** **EXE** **1** **0** **EXE** **2** **EXE** **ESC**  
**F3** (TYPE) **1** (Y=)  $\text{X},\theta,T$   $x^2$  **-** **3** **EXE**  
 $\leftarrow$   $\text{X},\theta,T$  **+** **2** **EXE**  
**F5** (DRAW)
- ② **F2** (ZOOM) **8** (Rnd)
- ③ **F1** (TRACE)  
 $\leftarrow$  ~  $\leftarrow$

**Result Screen**

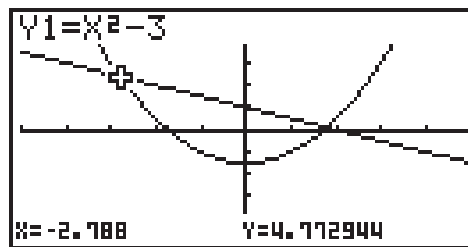

## ■ Calculating the Root

### Description

This feature provides a number of different methods for analyzing graphs.

### Set Up

1. Draw the graphs.

### Execution

2. Select the analysis function.

- F4** (G-SLV) **1** (Root) ... Calculation of root
- 2** (Max) ... Maximum value
- 3** (Min) ... Minimum value
- 4** (Y-Intcpt) ... y-intercept
- 5** (Isect) ... Intersection of two graphs
- 6** (Y-Cal) ... y-coordinate for given x-coordinate
- 7** (X-Cal) ... x-coordinate for given y-coordinate
- 8** ( $\int dx$ ) ... Integral value for a given range

3. When there are multiple graphs on the screen, the selection cursor (■) is located at the lowest numbered graph. Use the cursor keys to move the cursor to the graph you want to select.
4. Press **EXE** to select the graph where the cursor is located and display the value produced by the analysis.  
When an analysis produces multiple values, press **▶** to calculate the next value.  
Pressing **◀** returns to the previous value.





**Example** Draw the graph shown below and calculate the root for Y1.

$$Y1 = x(x + 2)(x - 2)$$

Use the following V-Window settings.

$$Xmin = -6.3, \quad Xmax = 6.3, \quad Xscale = 1$$

$$Ymin = -3.1, \quad Ymax = 3.1, \quad Yscale = 1 \text{ (initial defaults)}$$

### Procedure

- ① **MENU** GRPH•TBL  
**SHIFT** **OPTN** (V-Window) **F1** (INIT) **ESC**  
**F3** (TYPE) **1** (Y=) **X,θ,T** **←** **X,θ,T** **+** **2** **)** **←** **X,θ,T** **-** **2** **)** **EXE**  
**F5** (DRAW)
- ② **F4** (G-SLV) **1** (Root)
- ⋮
- ④ **▶**
- ▶**

### Result Screen

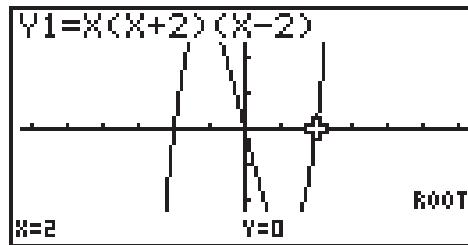
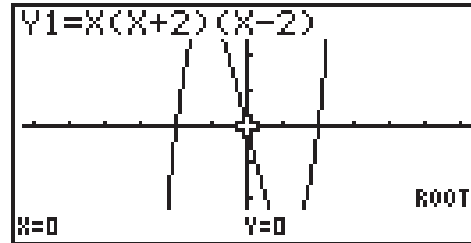
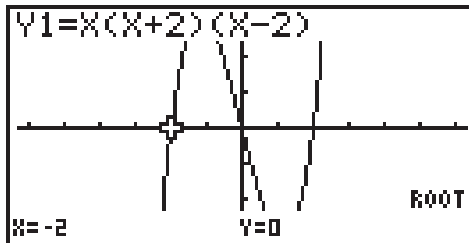

# When analyzing a single graph, results appear as soon as you select an analysis function in step 2, so step 3 is not necessary.

# Root, maximum value, minimum value, and y-intercept can be calculated for rectangular coordinate graphs and inequality graphs only.

# The y-intercept is the point where the graph crosses the y-axis.

---

## ■ Calculating the Point of Intersection of Two Graphs

### Description

Use the following procedure to calculate the point of intersection of two graphs.

---

### Set Up

- 1. Draw the graphs.

### Execution

- 2. Press **F4** (G-SLV) **F5** (Isect). When there are three or more graphs, the selection cursor (■) appears at the lowest numbered graph.
- 3. Use the cursor keys to move the cursor to the graph you want to select.
- 4. Press **EXE** to select the first graph, which changes the shape of the cursor from ■ to ◆.
- 5. Use the cursor keys to move the cursor to the second graph.
- 6. Press **EXE** to calculate the point of intersection for the two graphs.  
When an analysis produces multiple values, press **▶** to calculate the next value.  
Pressing **◀** returns to the previous value.



● ● ● ● ●  
**Example**

Graph the two functions shown below, and determine the point of intersection between Y1 and Y2.

$Y1 = x + 1$ ,  $Y2 = x^2$

Use the following V-Window settings.

Xmin = -5, Xmax = 5, Xscale = 1

Ymin = -5, Ymax = 5, Yscale = 1

**Procedure**

- ① **MENU** GRPH•TBL  
 $\text{[SHIFT] [OPTN] (V-Window) [(-) [5] [EXE] [5] [EXE] [1] [EXE] [V]}$   
 $\text{[(-) [5] [EXE] [5] [EXE] [1] [EXE] [ESC]}$   
 $\text{[F3] (TYPE) [1] (Y=) [X,θ,T] [+ [1] [EXE]}$   
 $\text{[X,θ,T] [x^2] [EXE]}$   
**[F5] (DRAW)**
- ② **[F4] (G-SLV) [5] (Isect)**
- ⋮
- ⑥ **[▶]**

**Result Screen**

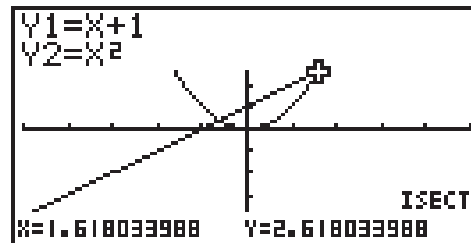
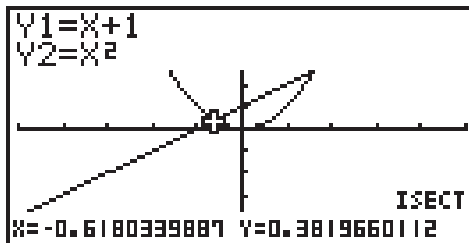

# In the case of two graphs, the point of intersection is calculated immediately after you press **[F4] [5]** in step 2.

# You can calculate the point of intersection for rectangular coordinate graphs and inequality graphs only.

---

## ■ Determining the Coordinates for Given Points

### Description

The following procedure describes how to determine the  $y$ -coordinate for a given  $x$ , and the  $x$ -coordinate for a given  $y$ .

---

### Set Up

- 1. Draw the graph.

### Execution

- 2. Select the function you want to perform. When there are multiple graphs, the selection cursor (■) appears at the lowest numbered graph.
  - F4** (G-SLV) **6** (Y-Cal) ...  $y$ -coordinate for given  $x$
  - 7** (X-Cal) ...  $x$ -coordinate for given  $y$
- 3. Use **▲** **▼** to move the cursor (■) to the graph you want, and then press **EXE** to select it.
- 4. Input the given  $x$ -coordinate value or  $y$ -coordinate value.  
Press **EXE** to calculate the corresponding  $y$ -coordinate value or  $x$ -coordinate value.





● ● ● ● ●  
**Example**

Graph the two functions shown below and then determine the y-coordinate for  $x = 0.5$  and the x-coordinate for  $y = 2.2$  on graph Y2.  
 $Y1 = x + 1$ ,  $Y2 = x(x + 2)(x - 2)$

Use the following V-Window settings.

Xmin = -6.3, Xmax = 6.3, Xscale = 1

Ymin = -3.1, Ymax = 3.1, Yscale = 1 (initial defaults)

**Procedure**

- |                                                                                                                                                                                                                                                                                                                                       |                                                                                                                         |                                                                                                                         |
|---------------------------------------------------------------------------------------------------------------------------------------------------------------------------------------------------------------------------------------------------------------------------------------------------------------------------------------|-------------------------------------------------------------------------------------------------------------------------|-------------------------------------------------------------------------------------------------------------------------|
| <p>① <b>MENU</b> GRPH•TBL<br/> <b>SHIFT</b> <b>OPTN</b> (V-Window) <b>F1</b> (INIT) <b>ESC</b><br/> <b>F3</b> (TYPE) <b>1</b> (Y=) <b>X,θ,T</b> <b>+</b> <b>1</b> <b>EXE</b><br/> <b>X,θ,T</b> <b>(</b> <b>X,θ,T</b> <b>+</b> <b>2</b> <b>)</b> <b>(</b> <b>X,θ,T</b> <b>-</b> <b>2</b> <b>)</b> <b>EXE</b><br/> <b>F5</b> (DRAW)</p> | <p>② <b>F4</b> (G-SLV) <b>6</b> (Y-Cal)</p> <p>③ <b>▼</b> <b>EXE</b></p> <p>④ <b>0</b> <b>.</b> <b>5</b> <b>EXE</b></p> | <p>② <b>F4</b> (G-SLV) <b>7</b> (X-Cal)</p> <p>③ <b>▼</b> <b>EXE</b></p> <p>④ <b>2</b> <b>.</b> <b>2</b> <b>EXE</b></p> |
|---------------------------------------------------------------------------------------------------------------------------------------------------------------------------------------------------------------------------------------------------------------------------------------------------------------------------------------|-------------------------------------------------------------------------------------------------------------------------|-------------------------------------------------------------------------------------------------------------------------|

**Result Screen**

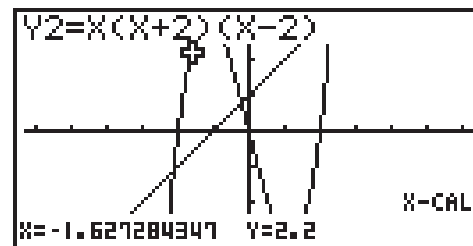
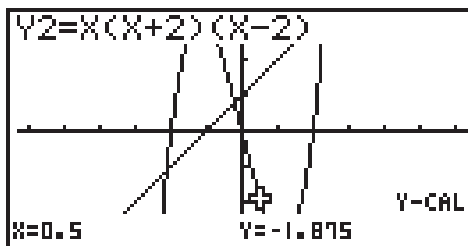

# When there are multiple results for the above procedure, press **▶** to calculate the next value. Pressing **◀** returns to the previous value.  
 # Step 3 of the above procedure is skipped when there is only one graph on the display.

# The X-Cal value cannot be obtained for a parametric function graph.  
 # After obtaining coordinates with the above procedure, you can input different coordinates by first pressing **X,θ,T**.

## ■ Calculating the Integral Value for a Given Range

### Description

Use the following procedure to obtain integration values for a given range.

### Set Up

1. Draw the graph.

### Execution

2. Press **F4** (G-SLV) **8** ( $\int dx$ ). When there are multiple graphs, this causes the selection cursor (■) to appear at the lowest numbered graph.
3. Use **▲** **▼** to move the cursor (■) to the graph you want, and then press **EXE** to select it.
4. Use **◀** to move the lower limit pointer to the location you want, and then press **EXE**.  
You can also move the pointer by pressing **X,0,T** to display the pop-up window, and then inputting coordinates.
5. Use **▶** to move the upper limit pointer to the location you want.  
You can also move the pointer by pressing **X,0,T** to display the pop-up window, and then inputting the upper limit and lower limit values for the integration range.
6. Press **EXE** to calculate the integral value.



# When setting the range, make sure that the lower limit is less than the upper limit.

# Integral values can be calculated for rectangular coordinate graphs only.



**Example** Graph the function shown below, and then determine the integral value at  $(-2, 0)$ .

$$Y1 = x(x + 2)(x - 2)$$

Use the following V-Window settings.

$$Xmin = -6.3, \quad Xmax = 6.3, \quad Xscale = 1$$

$$Ymin = -4, \quad Ymax = 4, \quad Yscale = 1$$

### Procedure

- ① **MENU** GRPH•TBL  
**SHIFT** **OPTN** (V-Window) **(←)** **6** **•** **3** **EXE** **6** **•** **3** **EXE** **1** **EXE** **▼**  
**(←)** **4** **EXE** **4** **EXE** **1** **EXE** **ESC**  
**F3** (TYPE) **1** (Y=) **(X,θ,T)** **(←)** **(X,θ,T)** **+** **2** **)** **(←)** **(X,θ,T)** **-** **2** **)** **EXE**  
**F5** (DRAW)
- ② **F4** (G-SLV) **8** ( $\int dx$ )
- ⋮
- ④ **◀** ~ **◀** **EXE**
- ⑤ **▶** ~ **▶** (Upper limit;  $x = 0$ )
- ⑥ **EXE**

### Result Screen

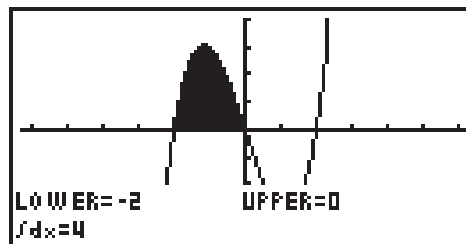

## ■ Implicit Function Graph Analysis

You can determine approximations of the following analytical results using implicit function graphs.

- Focus/vertex/eccentricity
- Latus rectum
- Center/radius
- $x$ -/ $y$ -intercept
- Directrix/axis of symmetry drawing and analysis
- Asymptote drawing and analysis

After graphing an implicit function, press **F4** (G-SLV) to display the following graph analysis menus.

### • Parabolic Graph Analysis

- **{Focus}/{Vertex}/{Length}/{e}** ... {focus}/{vertex}/{latus rectum}/{eccentricity}
- **{Dirtrx}/{Sym}** ... {directrix}/{axis of symmetry}
- **{X-icpt}/{Y-icpt}** ... { $x$ -intercept}/{ $y$ -intercept}

### • Circular Graph Analysis

- **{Center}/{Radius}** ... {center}/{radius}
- **{X-icpt}/{Y-icpt}** ... { $x$ -intercept}/{ $y$ -intercept}

### • Elliptical Graph Analysis

- **{Focus}/{Vertex}/{Center}/{e}** ... {focus}/{vertex}/{center}/{eccentricity}
- **{X-icpt}/{Y-icpt}** ... { $x$ -intercept}/{ $y$ -intercept}

### • Hyperbolic Graph Analysis

- **{Focus}/{Vertex}/{Center}/{e}** ... {focus}/{vertex}/{center}/{eccentricity}
- **{Asympt}** ... {asymptote}
- **{X-icpt}/{Y-icpt}** ... { $x$ -intercept}/{ $y$ -intercept}

The following examples show how to use the above menus with various types of implicit function graphs.



• To calculate the focus, vertex and latus rectum

[G-SLV]-[Focus]/[Vertex]/[Length]



**Example** To determine the focus, vertex and latus rectum for the parabola  
 $X = (Y - 2)^2 + 3$

Use the following V-Window settings.

**Xmin = -1, Xmax = 10, Xscale = 1**

**Ymin = -5, Ymax = 5, Yscale = 1**

[F4] (G-SLV)  
[1] (Focus)  
(Calculates the focus.)

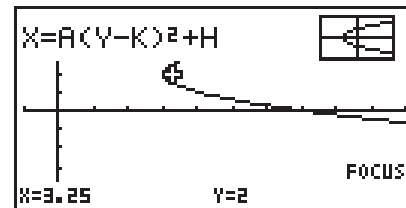

[ESC]  
[F4] (G-SLV)  
[3] (Vertex)  
(Calculates the vertex.)

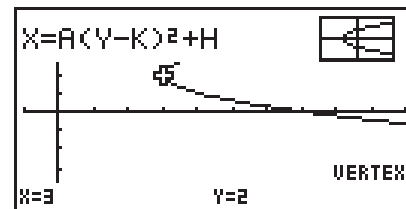

[ESC]  
[F4] (G-SLV)  
[5] (Length)  
(Calculates the latus rectum.)

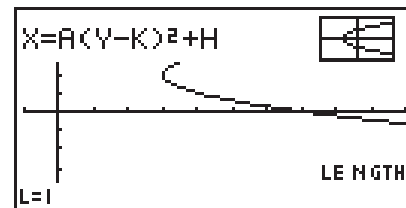

- When calculating two foci for an ellipse or hyperbolic graph, press  $\blacktriangleright$  to calculate the second focus. Pressing  $\blacktriangleleft$  returns to the first focus.
- When calculating two vertices for an ellipse or hyperbolic graph, press  $\blacktriangleright$  to calculate the second vertex. Pressing  $\blacktriangleleft$  returns to the first vertex.



• To calculate the center and radius

[G-SLV]-[Center]/[Radius]

• • • • •

**Example** To determine the center and radius for the circle

$$(X + 2)^2 + (Y + 1)^2 = 2^2$$

Use the following V-Window settings.

**Xmin = -6.3, Xmax = 6.3, Xscale = 1**

**Ymin = -3.1, Ymax = 3.1, Yscale = 1**

[F4] (G-SLV)

[1] (Center)

(Calculates the center.)

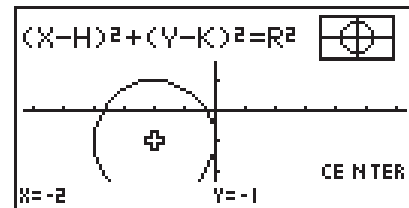

[ESC]

[F4] (G-SLV)

[2] (Radius)

(Calculates the radius.)

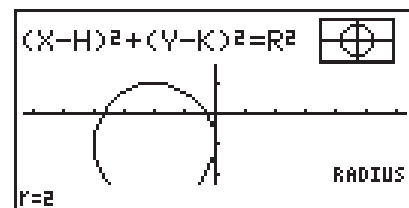

• To calculate the x- and y-intercepts

[G-SLV]-[X-ICPT]/[Y-ICPT]

• • • • •

**Example** To determine the x- and y-intercepts for the hyperbola

$$\frac{(X - 3)^2}{2^2} - \frac{(Y - 1)^2}{2^2} = 1$$

Use the following V-Window settings.

**Xmin = -4, Xmax = 8, Xscale = 1**

**Ymin = -5, Ymax = 5, Yscale = 1**

[F4] (G-SLV)

[6] (X-ICPT)

(Calculates the x-intercept.)

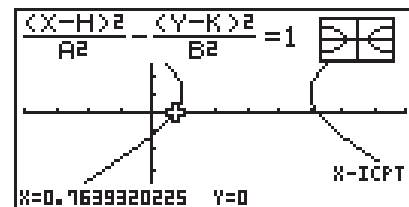

**ESC**

**F4** (G-SLV)

**7** (Y-Intpt)

(Calculates the y-intercept.)

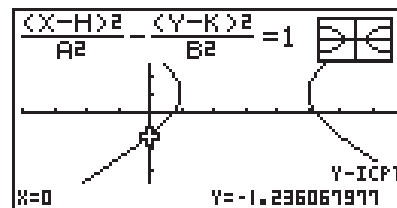

- Press **▶** to calculate the second set of  $x/y$ -intercepts. Pressing **◀** returns to the first set of intercepts.

• To draw and analyze the axis of symmetry and directrix

[G-SLV]-[Sym]/[Dirtrx]

• • • • •

**Example**

To draw the axis of symmetry and directrix for the parabola

$$X = 2(Y - 1)^2 + 1$$

Use the following V-Window settings.

$$X_{\min} = -6.3, \quad X_{\max} = 6.3, \quad X_{\text{scale}} = 1$$

$$Y_{\min} = -3.1, \quad Y_{\max} = 3.1, \quad Y_{\text{scale}} = 1$$

**F4** (G-SLV)

**4** (Sym)

(Draws the axis of symmetry.)

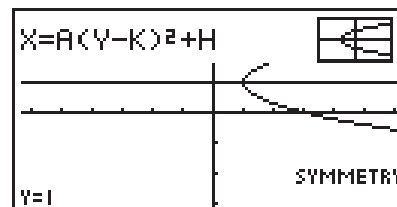

**ESC**

**F4** (G-SLV)

**2** (Dirtrx)

(Draws the directrix.)

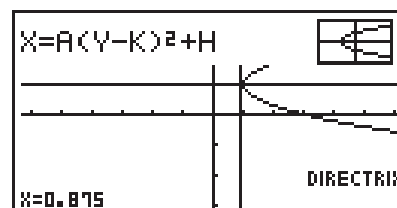

• To draw and analyze the asymptotes

[G-SLV]-[Asympt]



**Example** To draw the asymptotes for the hyperbola

$$\frac{(X - 1)^2}{2^2} - \frac{(Y - 1)^2}{2^2} = 1$$

Use the following V-Window settings.

**Xmin = -6.3, Xmax = 6.3, Xscale = 1**

**Ymin = -5, Ymax = 5, Yscale = 1**

**F4** (G-SLV)

**4** (Asympt)

(Draws the asymptotes.)

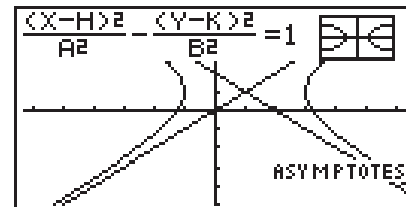

• To calculate eccentricity

[G-SLV]-[e]



**Example** To determine the eccentricity of the graph for ellipse

$$\frac{(X - 2)^2}{4^2} + \frac{(Y - 2)^2}{2^2} = 1$$

Use the following V-Window settings.

**Xmin = -3, Xmax = 7, Xscale = 1**

**Ymin = -1, Ymax = 5, Yscale = 1**

**F4** (G-SLV)

**4** (e)

(Calculates eccentricity.)

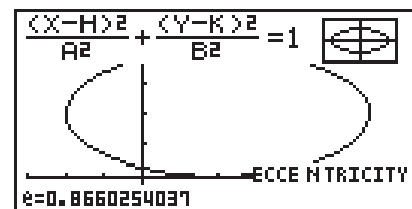

# Certain V-Window parameters can produce errors in values produced as graph analysis results.

# The message "Not Found" appears on the display when graph analysis is unable to produce a result.

# The following can result in inaccurate analysis results or may even make it impossible to obtain a solution at all.

- When the solution is tangent to the  $x$ -axis.
- When the solution is a point of tangency between two graphs.



# Chapter

# 6

# 6

## Statistical Graphs and Calculations

This chapter describes how to input statistical data into lists, and how to calculate the mean, maximum and other statistical values. It also tells you how to perform regression calculations.

- 6-1 Before Performing Statistical Calculations**
- 6-2 Calculating and Graphing Single-Variable Statistical Data**
- 6-3 Calculating and Graphing Paired-Variable Statistical Data**
- 6-4 Performing Statistical Calculations**

### **Important!**

- This chapter contains a number of graph screen shots. In each case, new data values were input in order to highlight the particular characteristics of the graph being drawn. Note that when you try to draw a similar graph, the unit uses data values that you have input using the List function. Because of this, the graphs that appear on the screen when you perform a graphing operation will probably differ somewhat from those shown in this manual.

## 6-1 Before Performing Statistical Calculations

From the Main Menu, enter the STAT Mode and display the statistical data lists.

Use the statistical data lists to input data and to perform statistical calculations.

Use  $\blacktriangle$ ,  $\blacktriangledown$ ,  $\blacktriangleleft$  and  $\blacktriangleright$  to move the highlighting around the lists.

|   | List 1 | List 2 | List 3 | List 4 |
|---|--------|--------|--------|--------|
| 1 |        |        |        |        |
| 2 |        |        |        |        |
| 3 |        |        |        |        |
| 4 |        |        |        |        |
| 5 |        |        |        |        |

GRAPHICAL DEL DELA INS  $\blacktriangleright$

Once you input data, you can use it to produce a graph and check for tendencies. You can also use a variety of different regression calculations to analyze the data.

### Inputting Data into Lists



**Example** To input the following two data groups

0.5, 1.2, 2.4, 4.0, 5.2

-2.1, 0.3, 1.5, 2.0, 2.4

$\boxed{0} \cdot \boxed{5} \boxed{\text{EXE}} \boxed{1} \cdot \boxed{2} \boxed{\text{EXE}}$   
 $\boxed{2} \cdot \boxed{4} \boxed{\text{EXE}} \boxed{4} \boxed{\text{EXE}} \boxed{5} \cdot \boxed{2} \boxed{\text{EXE}}$   
 $\blacktriangleright$   
 $\boxed{(-)} \boxed{2} \cdot \boxed{1} \boxed{\text{EXE}} \boxed{0} \cdot \boxed{3} \boxed{\text{EXE}}$   
 $\boxed{1} \cdot \boxed{5} \boxed{\text{EXE}} \boxed{2} \boxed{\text{EXE}} \boxed{2} \cdot \boxed{4} \boxed{\text{EXE}}$

|   | List 1 | List 2 | List 3 | List 4 |
|---|--------|--------|--------|--------|
| 2 | 1.2    | 0.3    |        |        |
| 3 | 2.4    | 1.5    |        |        |
| 4 | 4      | 2      |        |        |
| 5 | 5.2    | 2.4    |        |        |
| 6 |        |        |        |        |

GRAPHICAL DEL DELA INS  $\blacktriangleright$

Once data is input, you can use it for graphing and statistical calculations.



# Except for complex numbers, calculation results can be input as statistical data.

# You can use the  $\blacktriangle$ ,  $\blacktriangledown$ ,  $\blacktriangleleft$  and  $\blacktriangleright$  keys to move the highlighting to any cell in the lists for data input.

## ■ Changing Graph Parameters

Use the following procedures to specify the graph draw/non-draw status, the graph type, and other general settings for each of the graphs in the graph menu (GPH1, GPH2, GPH3).

While the statistical data list is on the display, press **[F1]**(GRPH) to display the graph menu, which contains the following items.

- **{S-Gph1}/{S-Gph2}/{S-Gph3}** ... graph {1}/{2}/{3} drawing<sup>1</sup>
- **{Select}** ... {simultaneous graph (GPH1, GPH2, GPH3) selection} (You can specify the multiple graphs.)
- **{Set}** ... {graph settings (graph type, list assignments)}

### 1. General graph settings

[GRPH]-[Set]

This section describes how to use the general graph settings screen to make the following settings for each graph (GPH1, GPH2, GPH3).

#### • Graph Type

The initial default graph type setting for all the graphs is scatter graph. You can select one of a variety of other statistical graph types for each graph.

#### • List

The initial default statistical data is List 1 for single-variable data, and List 1 and List 2 for paired-variable data. You can specify which statistical data list you want to use for  $x$ -data and  $y$ -data.

#### • Frequency

Normally, each data item or data pair in the statistical data list is represented on a graph as a point. When you are working with a large number of data items however, this can cause problems because of the number of plot points on the graph. When this happens, you can specify a frequency list that contains values indicating the number of instances (the frequency) of the data items in the corresponding cells of the lists you are using for  $x$ -data and  $y$ -data. Once you do this, only one point is plotted for the multiple data items, which makes the graph easier to read.



<sup>1</sup> The initial default graph type setting for all the graphs (Graph 1 through Graph 3) is scatter diagram, but you can change to one of a number of other graph types.

# You can specify the graph draw/non-draw status, the graph type, and other general settings for each of the graphs in the graph menu (GPH1, GPH2, GPH3).



- **Mark Type**

This setting lets you specify the shape of the plot points on the graph.

- **To display the general graph settings screen**

[GRPH]-[Set]

Pressing **[F1]** (GRPH) **[5]** (Set) displays the general graph settings screen.

```

StatGraph1
Graph Type  :Scatter
XList       :List1
YList       :List2
Frequency   :1
Mark Type   :◻
GP1|GP2|GP3
  
```

- The settings shown here are examples only. The settings on your general graph settings screen may differ.

- **StatGraph (statistical graph specification)**

- {GPH1}/{GPH2}/{GPH3} ... graph {1}/{2}/{3}

- **Graph Type (graph type specification)**

- {Scat}/{xy}/{NPP} ... {scatter diagram}/{xy line graph}/{normal probability plot}
- {Hist}/{Box}/{ModB}/{N-Dis}/{Brkn} ... {histogram}/{med-box graph}/{modified-box graph}/{normal distribution curve}/{line graph}
- {X}/{Med}/{X^2}/{X^3}/{X^4} ... {linear regression graph}/{Med-Med graph}/{quadratic regression graph}/{cubic regression graph}/{quartic regression graph}
- {Log}/{Exp}/{Pwr}/{Sin}/{Lgst} ... {logarithmic regression graph}/{exponential regression graph}/{power regression graph}/{sinusoidal regression graph}/{logistic regression graph}

- **XList (x-axis data list)**

- {LIST} ... {List 1 to 20}

- **YList (y-axis data list)**

- {LIST} ... {List 1 to 20}

- **Frequency (number of times a value occurs)**

- {1} ... {1-to-1 plot}
- {LIST} ... contents of these lists indicate the frequency of XList and YList data

- **Mark Type (plot mark type)**

- {◻}/{×}/{•} ... scatter diagram plot points



## 2. Graph draw/non-draw status

[GRPH]-[Select]

The following procedure can be used to specify the draw (On)/non-draw (Off) status of each of the graphs in the graph menu.

### • To specify the draw/non-draw status of a graph

1. Pressing **F1**(GRPH) **4**(Select) displays the graph On/Off screen.

```
StatGraph1 : DrawOn
StatGraph2 : DrawOff
StatGraph3 : DrawOff
```

- Note that the StatGraph1 setting is for Graph 1 (GPH1 of the graph menu), StatGraph2 is for Graph 2, and StatGraph3 is for Graph 3.
2. Use the cursor keys to move the highlighting to the graph whose status you want to change, and press the applicable function key to change the status.
    - **{On}/{Off}** ... {On (draw)}/{Off (non-draw)}
    - **{DRAW}** ... {draws all On graphs}
  3. To return to the graph menu, press **ESC**.



# View Window parameters are normally set automatically for statistical graphing. If you want to set View Window parameters manually, you must change the Stat Wind item to "Manual".  
While the statistical data list is on the display, perform the following procedure.

**CTRL F3**(SET UP) **F2**(Man)

**ESC** (Returns to previous menu.)

# The default setting automatically uses List 1 data as  $x$ -axis (horizontal) values and List 2 data as  $y$ -axis (vertical) values. Each set of  $x/y$  data is a point on the scatter diagram.

# Pressing **CTRL 0** does not hide the menu while a statistical graph is on the display.



## 6-2 Calculating and Graphing Single-Variable Statistical Data

Single-variable data is data with only a single variable. If you are calculating the average height of the members of a class for example, there is only one variable (height).

Single-variable statistics include distribution and sum. The following types of graphs are available for single-variable statistics.

You can also use the procedures under "Changing Graph Parameters" on page 6-1-2 to make the settings you want before drawing each graph.

### Normal Probability Plot (NPP)

This plot compares the data accumulated ratio with a normal distribution accumulated ratio. XList specifies the list where data is input, and Mark Type is used to select from among the marks {□ / × / •} you want to plot.

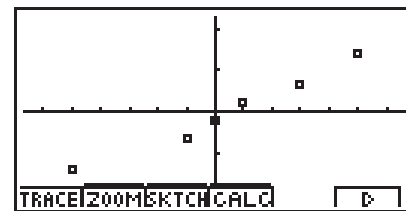

Press **ESC** or **SHIFT** **ESC** (QUIT) to return to the statistical data list.

### Histogram (Bar Graph) (Hist)

XList specifies the list where the data is input, while Freq specifies the list where the data frequency is input. 1 is specified for Freq when frequency is not specified.

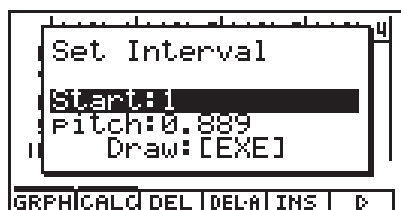

⇒  
**EXE** (Draw)

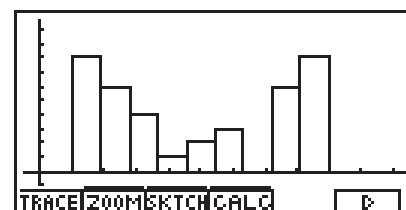

The display screen appears as shown above before the graph is drawn. At this point, you can change the Start and pitch values.

## ■ Med-box Graph (Box)

This type of graph lets you see how a large number of data items are grouped within specific ranges. A box encloses all the data in an area from the 25th percentile to the 75th percentile, with a line drawn at the 50th percentile. Lines (called whiskers) extend from either end of the box up to the minimum and maximum of the data.

XList specifies the list where the data is input, while Freq specifies the list where the data frequency is input. 1 is specified for Freq when frequency is not specified.

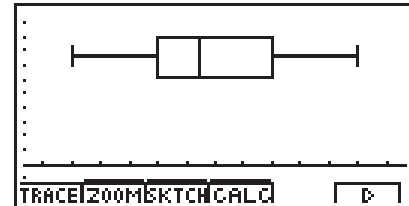

## ■ Modified Box Graph (ModB)

The modified box graph omits everything in the range past  $1.5 \times \text{IQR}$  ( $\text{IQR} = Q3 - Q1$ ,  $Q3$ : 3rd quartile,  $Q1$ : 1st quartile) from the med-box 4th quartile and draws whiskers.

Outliers are displayed as plot points.

XList specifies the list where the data is input, while Freq specifies the list where the data frequency is input. 1 is specified for Freq when frequency is not specified.

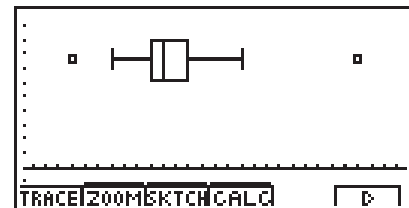

# Input a positive integer for frequency data.  
Other types of values (decimals, etc.) cause an error.

## ■ Normal Distribution Curve (N•Dis)

The normal distribution curve is graphed using the following normal distribution function.

$$y = \frac{1}{\sqrt{(2\pi) x \sigma_n}} e^{-\frac{(x-\bar{x})^2}{2x\sigma_n^2}}$$

XList specifies the list where the data is input, while Freq specifies the list where the data frequency is input. 1 is specified for Freq when frequency is not specified.

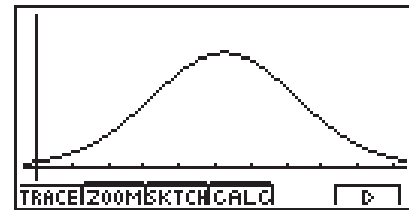

## ■ Line Graph (Brkn)

Lines connect center points of a histogram bar.

XList specifies the list where the data is input, while Freq specifies the list where the data frequency is input. 1 is specified for Freq when frequency is not specified.

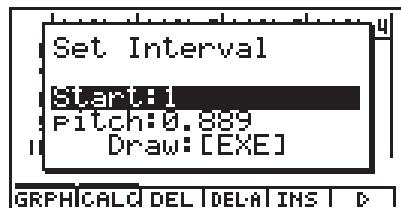

⇒  
[EXE] (Draw)

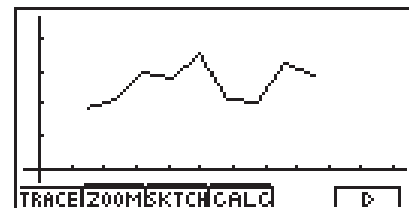

The display screen appears as shown above before the graph is drawn. At this point, you can change the Start and pitch values.



## ■ Displaying the Calculation Results of a Drawn Single-Variable Graph

Single-variable statistics can be expressed as both graphs and parameter values. When these graphs are displayed, the single-variable calculation results appear as shown below when you press **F4**(CALC) **1**(1VAR).

```

1-Variable
x      =154.8
Σx     =1548
Σx²    =239722
xσn   =3.02654919
xσn-1 =3.19026296
n      =10
↓
DRAW

```

- Use  to scroll the list so you can view the items that run off the bottom of the screen.

The following describes the meaning of each of the parameters.

$\bar{x}$  ..... mean  
 $\Sigma x$  ..... sum  
 $\Sigma x^2$  ..... sum of squares  
 $x\sigma_n$  ..... population standard deviation  
 $x\sigma_{n-1}$  ..... sample standard deviation  
 $n$  ..... number of data items  
minX ..... minimum  
Q1 ..... first quartile  
Med ..... median  
Q3 ..... third quartile  
maxX ..... maximum  
Mod ..... mode  
Mod :  $n$  ... number of data mode items  
Mod : F ... data mode frequency

- Press **F6**(DRAW) to return to the original single-variable statistical graph.



# When Mod has multiple solutions, they are all displayed.

## 6-3 Calculating and Graphing Paired-Variable Statistical Data

---

### ■ Drawing a Scatter Diagram and $xy$ Line Graph

#### Description

The following procedure plots a scatter diagram and connects the dots to produce an  $xy$  line graph.

---

#### Set Up

1. From the Main Menu, enter the STAT Mode.

#### Execution

2. Input the data into a list.
3. Specify Scat (scatter diagram) or  $xy$  ( $xy$  line graph) as the graph type, and then execute the graph operation.

Press **ESC** or **SHIFT** **ESC** (QUIT) to return to the statistical data list.





**Example** Input the two sets of data shown below. Next, plot the data on a scatter diagram and connect the dots to produce an  $xy$  line graph.

0.5, 1.2, 2.4, 4.0, 5.2,  
-2.1, 0.3, 1.5, 2.0, 2.4

### Procedure

- ① **MENU** STAT
- ② **0** **.** **5** **EXE** **1** **.** **2** **EXE**  
**2** **.** **4** **EXE** **4** **EXE** **5** **.** **2** **EXE**  
**▶**  
**(←)** **2** **.** **1** **EXE** **0** **.** **3** **EXE**  
**1** **.** **5** **EXE** **2** **EXE** **2** **.** **4** **EXE**
- ③ (Scatter diagram) **F1** (GRPH) **5** (Set) **▼** **F1** (Scat) **ESC**  
**F1** (GRPH) **1** (S-Gph1)
- ③ ( $xy$  line graph) **F1** (GRPH) **5** (Set) **▼** **F2** ( $xy$ ) **ESC**  
**F1** (GRPH) **1** (S-Gph1)

### Result Screen

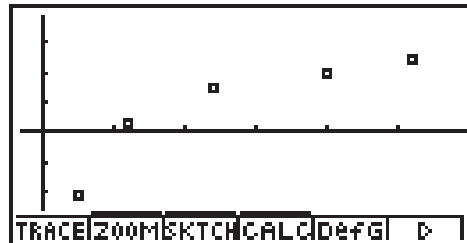

(Scatter diagram)

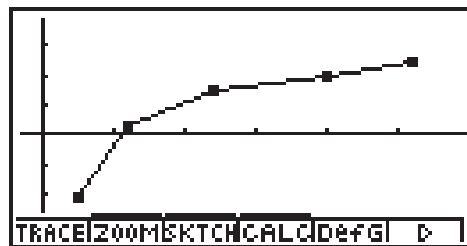

( $xy$  line graph)



---

## ■ Drawing a Regression Graph

### Description

Use the following procedure to input paired-variable statistical data, perform a regression calculation using the data, and then graph the results.

---

### Set Up

- 1. From the Main Menu, enter the STAT Mode.

### Execution

- 2. Input the data into a list, and plot the scatter diagram.
- 3. Select the regression type, execute the calculation, and display the regression parameters.
- 4. Draw the regression graph.



# You can perform trace on a regression graph.  
You cannot perform trace scroll.

• • • • •  
**Example**

Input the two sets of data shown below and plot the data on a scatter diagram. Next, perform logarithmic regression on the data to display the regression parameters, and then draw the corresponding regression graph.

0.5, 1.2, 2.4, 4.0, 5.2,  
 -2.1, 0.3, 1.5, 2.0, 2.4

---

### Procedure

- ① **MENU** STAT
- ② **0** **.** **5** **EXE** **1** **.** **2** **EXE**  
**2** **.** **4** **EXE** **4** **EXE** **5** **.** **2** **EXE**  
**▶**  
**(←)** **2** **.** **1** **EXE** **0** **.** **3** **EXE**  
**1** **.** **5** **EXE** **2** **EXE** **2** **.** **4** **EXE**  
**F1**(GRPH) **5**(Set) **▼** **F1**(Scat) **ESC**  
**F1**(GRPH) **1**(S-Gph1)
- ③ **F4**(CALC) **7**(Log)
- ④ **F6**(DRAW)

---

### Result Screen

```

LogRes
  a =-0.4546843
  b =1.87475856
  r =0.98216271
  r²=0.9646436
y=a+b·lnx
                                     [COPY|DRAW]
  
```



## ■ Selecting the Regression Type

After you graph paired-variable statistical data, press **F4** (CALC). Then you can use the function menu at the bottom of the display to select from a variety of different types of regression.

- **{2VAR}** ... {paired-variable statistical results}
- **{Linear}/{MedMed}/{Quad}/{Cubic}/{Quart}/{Log}/{Exp}/{Power}/{Sin}/{Lgstic}**  
... {linear regression}/{Med-Med}/{quadratic regression}/{cubic regression}/{quartic regression}/{logarithmic regression}/{exponential regression}/{power regression}/{sinusoidal regression}/{logistic regression} calculation and graphing

## ■ Displaying Statistical Calculation Results

Whenever you perform a regression calculation, the regression formula parameter (such as  $a$  and  $b$  in the linear regression  $y = ax + b$ ) calculation results appear on the display. You can use these to obtain statistical calculation results.

Regression parameters are calculated as soon as you press a function key to select a regression type while a graph is on the display.

## ■ Graphing Statistical Calculation Results

While the parameter calculation result is on the display, you can graph the displayed regression formula by pressing **F6** (DRAW).



## ■ Linear Regression Graph

Linear regression uses the method of least squares to plot a straight line that passes close to as many data points as possible, and returns values for the slope and  $y$  - intercept ( $y$  -coordinate when  $x = 0$ ) of the line.

The graphic representation of this relationship is a linear regression graph.

**F4** (CALC) **2** (Linear)

**F6** (DRAW)

The following is the linear regression model formula.

$$y = ax + b$$

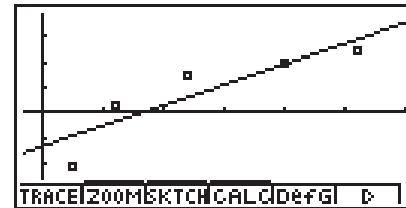

$a$  ..... regression coefficient (slope)

$b$  ..... regression constant term (intercept)

$r$  ..... correlation coefficient

$r^2$  ..... coefficient of determination

## ■ Med-Med Graph

When it is suspected that there are a number of extreme values, a Med-Med graph can be used in place of the least squares method. This is similar to linear regression, but it minimizes the effects of extreme values.

**F4** (CALC) **3** (MedMed)

**F6** (DRAW)

The following is the Med-Med graph model formula.

$$y = ax + b$$

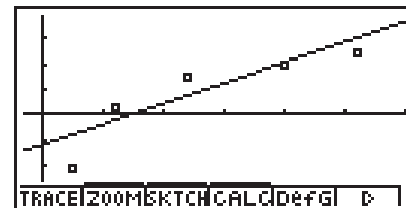

$a$  ..... Med-Med graph slope

$b$  ..... Med-Med graph intercept



# Input a positive integer for frequency data.  
Other types of values (decimals, etc.) cause an error.

## ■ Quadratic/Cubic/Quartic Regression Graph

A quadratic/cubic/quartic regression graph represents connection of the data points of a scatter diagram. It uses the method of least squares to draw a curve that passes close to as many data points as possible. The formula that represents this is quadratic/cubic/quartic regression.

Ex. Quadratic regression

**F4** (CALC) **4** (Quad)

**F6** (DRAW)

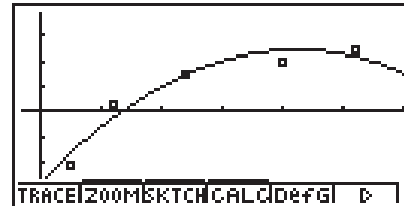

### Quadratic regression

Model formula .....  $y = ax^2 + bx + c$

$a$  ..... regression second coefficient

$b$  ..... regression first coefficient

$c$  ..... regression constant term (intercept)

### Cubic regression

Model formula .....  $y = ax^3 + bx^2 + cx + d$

$a$  ..... regression third coefficient

$b$  ..... regression second coefficient

$c$  ..... regression first coefficient

$d$  ..... regression constant term (intercept)

### Quartic regression

Model formula .....  $y = ax^4 + bx^3 + cx^2 + dx + e$

$a$  ..... regression fourth coefficient

$b$  ..... regression third coefficient

$c$  ..... regression second coefficient

$d$  ..... regression first coefficient

$e$  ..... regression constant term (intercept)



## ■ Logarithmic Regression Graph

Logarithmic regression expresses  $y$  as a logarithmic function of  $x$ . The standard logarithmic regression formula is  $y = a + b \times \ln x$ , so if we say that  $X = \ln x$ , the formula corresponds to linear regression formula  $y = a + bX$ .

**F4** (CALC) **7** (Log)

**F6** (DRAW)

The following is the logarithmic regression model formula.

$$y = a + b \cdot \ln x$$

$a$  ..... regression constant term

$b$  ..... regression coefficient

$r$  ..... correlation coefficient

$r^2$  ..... coefficient of determination

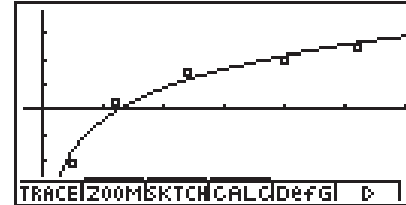

## ■ Exponential Regression Graph

Exponential regression expresses  $y$  as a proportion of the exponential function of  $x$ . The standard exponential regression formula is  $y = a \times e^{bx}$ , so if we take the logarithms of both sides we get  $\ln y = \ln a + bx$ . Next, if we say  $Y = \ln y$ , and  $a = \ln a$ , the formula corresponds to linear regression formula  $Y = a + bx$ .

**F4** (CALC) **8** (Exp)

**F6** (DRAW)

The following is the exponential regression model formula.

$$y = a \cdot e^{bx}$$

$a$  ..... regression coefficient

$b$  ..... regression constant term

$r$  ..... correlation coefficient

$r^2$  ..... coefficient of determination

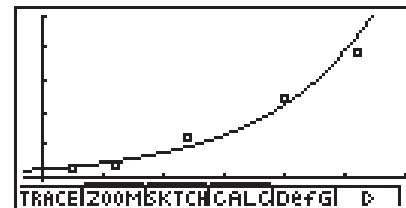

## ■ Power Regression Graph

Power regression expresses  $y$  as a proportion of the power of  $x$ . The standard power regression formula is  $y = a \times x^b$ , so if we take the logarithms of both sides we get  $\ln y = \ln a + b \times \ln x$ . Next, if we say  $X = \ln x$ ,  $Y = \ln y$ , and  $a = \ln a$ , the formula corresponds to linear regression formula  $Y = a + bX$ .

**F4** (CALC) **9** (Power)

**F6** (DRAW)

The following is the power regression model formula.

$$y = a \cdot x^b$$

$a$  ..... regression coefficient

$b$  ..... regression power

$r$  ..... correlation coefficient

$r^2$  ..... coefficient of determination

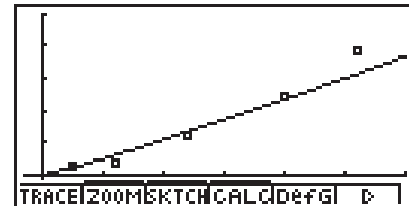

## ■ Sinusoidal Regression Graph

Sinusoidal regression is best applied for cyclical data.

The following is the sinusoidal regression model formula.

$$y = a \cdot \sin(bx + c) + d$$

While the statistical data list is on the display, perform the following key operation.

**F4** (CALC) **X,θ,T** (Sin)

**F6** (DRAW)

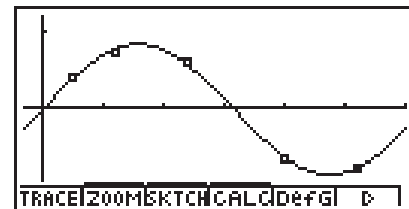

Drawing a sinusoidal regression graph causes the angle unit setting of the calculator to automatically change to Rad (radians). The angle unit does not change when you perform a sinusoidal regression calculation without drawing a graph.

- Certain types of data may take a long time to calculate. This does not indicate malfunction.

## ■ Logistic Regression Graph

Logistic regression is best applied for time-based phenomena in which there is a continual increase until a saturation point is reached.

The following is the logistic regression model formula.

$$y = \frac{c}{1 + ae^{-bx}}$$

**F4** (CALC) **log** (Lgstic)

**F6** (DRAW)

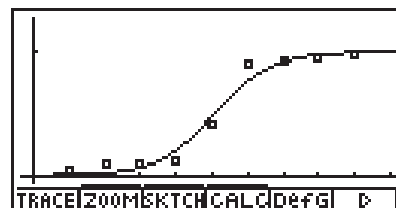

- Certain types of data may take a long time to calculate. This does not indicate malfunction.

## ■ Residual Calculation

Actual plot points ( $y$ -coordinates) and regression model distance can be calculated during regression calculations.

While the statistical data list is on the display, recall the SET UP screen to specify a LIST ("List 1" through "List 20") for "Resid List". Calculated residual data is stored in the specified list.

The vertical distance from the plots to the regression model will be stored in the list.

Plots that are higher than the regression model are positive, while those that are lower are negative.

Residual calculation can be performed and saved for all regression models.



# Any data already existing in the selected list is cleared. The residual of each plot is stored in the same precedence as the data used as the model.

## ■ Displaying the Calculation Results of a Drawn Paired-Variable Graph

Paired-variable statistics can be expressed as both graphs and parameter values. When these graphs are displayed, the paired-variable calculation results appear as shown below when you press **F4** (CALC) **1** (2VAR).

```

2-Variable
x̄ = 2.66
Σx = 13.3
Σx² = 50.49
xσn = 1.7385051
xσn-1 = 1.94370779
n = 5
DRAW
  
```

- Use  to scroll the list so you can view the items that run off the bottom of the screen.

|                       |                                                          |                       |                                                          |
|-----------------------|----------------------------------------------------------|-----------------------|----------------------------------------------------------|
| $\bar{x}$ .....       | mean of data stored in $x$ List                          | $\Sigma y^2$ .....    | sum of squares of data stored in $y$ List                |
| $\Sigma x$ .....      | sum of data stored in $x$ List                           | $y\sigma_n$ .....     | population standard deviation of data stored in $y$ List |
| $\Sigma x^2$ .....    | sum of squares of data stored in $x$ List                | $y\sigma_{n-1}$ ..... | sample standard deviation of data stored in $y$ List     |
| $x\sigma_n$ .....     | population standard deviation of data stored in $x$ List | $\Sigma xy$ .....     | sum of data stored in $x$ List and $y$ List              |
| $x\sigma_{n-1}$ ..... | sample standard deviation of data stored in $x$ List     | minX ...              | minimum of data stored in $x$ List                       |
| $n$ .....             | number of data                                           | maxX ..               | maximum of data stored in $x$ List                       |
| $\bar{y}$ .....       | mean of data stored in $y$ List                          | minY ...              | minimum of data stored in $y$ List                       |
| $\Sigma y$ .....      | sum of data stored in $y$ List                           | maxY ..               | maximum of data stored in $y$ List                       |

## ■ Copying a Regression Graph Formula to the GRPH•TBL Mode

You can copy regression formula calculation results to the GRPH•TBL Mode graph formula area, and store and compare.

1. Press **F5** (COPY) to copy the regression formula that produced the displayed data to the GRPH•TBL Mode graph formula area\*<sup>1</sup>.
2. Press **EXE** to save the copied graph formula and return to the previous regression calculation result display.



\*<sup>1</sup>You cannot edit regression formulas for graph formulas in the GRPH•TBL Mode.

## Multiple Graphs

You can draw more than one graph on the same display by using the procedure under “Changing Graph Parameters” to set the graph draw (On)/non-draw (Off) status of two or all three of the graphs to draw On, and then pressing **F6** (DRAW) (see page 6-1-4). After drawing the graphs, you can select which graph formula to use when performing single-variable statistic or regression calculations.

```
StatGraph1 : DrawOn
StatGraph2 : DrawOff
StatGraph3 : DrawOn
```

**F4** (CALC)

**2** (Linear)

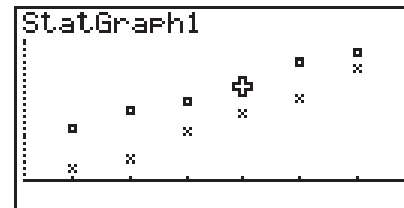

- The text at the top of the screen indicates the currently selected graph (StatGraph1 = Graph 1, StatGraph2 = Graph 2, StatGraph3 = Graph 3).

1. Press **▼**. The graph name at the top of the screen changes when you do.

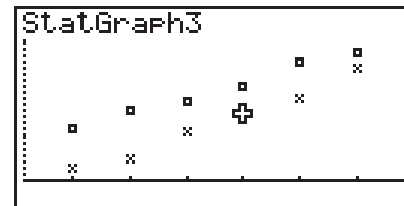

2. When graph you want to use is selected, press **EXE**.

```
LinearReg
a = 3.38571428
b = -2.1
r = 0.98898975
r² = 0.97810074
y = ax + b
```

Now you can use the procedure under “Displaying the Calculation Results of a Drawn Paired-Variable Graph” on page 6-3-11 to perform statistical calculations.

---

## ■ Overlaying a Function Graph on a Statistical Graph

### Description

You can overlay a paired-variable statistical graph with any type of function graph you want.

---

### Set Up

- 1. From the Main Menu, enter the STAT Mode.

### Execution

- 2. Input the data into a list, and draw the statistical graph.
- 3. Display the Graph Function menu, and input the function you want to overlay on the statistical graph.
- 4. Graph the function.





**Example** Input the two sets of data shown below. Next, plot the data on a scatter diagram and overlay a function graph  $y = 2\ln x$ .

0.5, 1.2, 2.4, 4.0, 5.2,

-2.1, 0.3, 1.5, 2.0, 2.4

### Procedure

- ① **MENU** STAT
- ② **0** **.** **5** **EXE** **1** **.** **2** **EXE**  
**2** **.** **4** **EXE** **4** **EXE** **5** **.** **2** **EXE**  
**▶**  
**(←)** **2** **.** **1** **EXE** **0** **.** **3** **EXE**  
**1** **.** **5** **EXE** **2** **EXE** **2** **.** **4** **EXE**  
**F1**(GRPH) **1**(S-Gph1)
- ③ **F5**(DefG)  
**2** **In** **X,θ,T** **EXE** (Register Y1 =  $2\ln x$ )
- ④ **F6**(DRAW)

### Result Screen

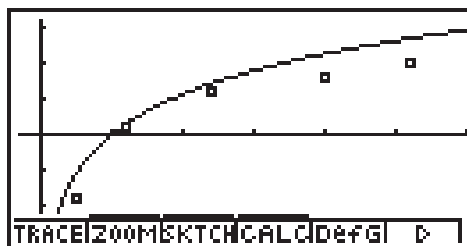

# You can also perform trace, etc. for drawn function graphs.  
 # Graphs of types other than rectangular coordinate graphs cannot be drawn.

# Pressing **ESC** while inputting a function returns the expression to what it was prior to input. Pressing **SHIFT** **ESC** (QUIT) clears the input expression and returns to the statistical data list.

## 6-4 Performing Statistical Calculations

All of the statistical calculations up to this point were performed after displaying a graph. The following procedures can be used to perform statistical calculations alone.

### • To specify statistical calculation data lists

You have to input the statistical data for the calculation you want to perform and specify where it is located before you start a calculation. Display the statistical data and then press

**2** (CALC) **4** (Set).

```

1Var XList :List1
1Var Freq  :1
2Var XList :List1
2Var YList :List2
2Var Freq  :1
LIST
  
```

The following is the meaning for each item.

- 1Var XList ..... location of single-variable statistic  $x$  values (XList)
- 1Var Freq ..... location of single-variable frequency values (Frequency)
- 2Var XList ..... location of paired-variable statistic  $x$  values (XList)
- 2Var YList ..... location of paired-variable statistic  $y$  values (YList)
- 2Var Freq ..... location of paired-variable frequency values (Frequency)

- Calculations in this section are performed based on the above specifications.





## ■ Single-Variable Statistical Calculations

In the previous examples from “Drawing a Normal Probability Plot” and “Histogram (Bar Graph)” to “Line Graph,” statistical calculation results were displayed after the graph was drawn. These were numeric expressions of the characteristics of variables used in the graphic display.

These values can also be directly obtained by displaying the statistical data list and pressing **F2** (CALC) **1** (1VAR).

```

1-Variable
x̄      =154.8
Σx     =1548
Σx²    =239722
x̄n     =3.02654919
x̄n-1  =3.19026296
n      =10
  
```

After this, pressing **▲** or **▼** scrolls the statistical calculation result display so you can view variable characteristics.

For details on the meanings of these statistical values, see “Displaying the Calculation Results of a Drawn Single-Variable Graph” (page 6-2-4).

## ■ Paired-Variable Statistical Calculations

In the previous examples from “Linear Regression Graph” to “Logistic Regression Graph,” statistical calculation results were displayed after the graph was drawn. These were numeric expressions of the characteristics of variables used in the graphic display.

These values can also be directly obtained by displaying the statistical data list and pressing **F2** (CALC) **2** (2VAR).

```

2-Variable
x̄      =20
Σx     =100
Σx²    =2250
x̄n     =7.07106781
x̄n-1  =7.90569415
n      =5
  
```

After this, pressing **▲** or **▼** scrolls the statistical calculation result display so you can view variable characteristics.

For details on the meanings of these statistical values, see “Displaying the Calculation Results of a Drawn Paired-Variable Graph” (page 6-3-11).



## ■ Regression Calculation

In the explanations from “Linear Regression Graph” to “Logistic Regression Graph,” regression calculation results were displayed after the graph was drawn. Here, each coefficient value of the regression line and regression curve is expressed as a number.

You can directly determine the same expression from the data input screen.

Pressing **F2**(CALC) **3**(REG) displays the pull-up menu, which contains the following items.

- **{Linear}/{MedMed}/{Quad}/{Cubic}/{Quart}/{Log}/{Exp}/{Power}/{Sin}/{Lgstic} ...**  
 {linear regression}/{Med-Med}/{quadratic regression}/{cubic regression}/  
 {quartic regression}/{logarithmic regression}/{exponential regression}/  
 {power regression}/{sinusoidal regression}/ {logistic regression} parameters



**Example** To display single-variable regression parameters

**F2**(CALC) **3**(REG) **1**(Linear)

```
LinearReg
a =0.56
b =997.4
r =0.98260736
r²=0.96551724
y=ax+b
```

The meanings of the parameters that appear on this screen are the same as those for “Linear Regression Graph” to “Logistic Regression Graph”.



## ■ Estimated Value Calculation ( $\hat{x}$ , $\hat{y}$ )

After drawing a regression graph with the **STAT Mode**, you can use the **RUN • MAT Mode** to calculate estimated values for the regression graph's  $x$  and  $y$  parameters.

● ● ● ● ●

**Example** To perform power regression using the nearby data and estimate the values of  $\hat{y}$  and  $\hat{x}$  when  $x_i = 20$  and  $y_i = 1000$

| $x_i$ | $y_i$ |
|-------|-------|
| 10    | 1003  |
| 15    | 1005  |
| 20    | 1010  |
| 25    | 1011  |
| 30    | 1014  |

1. From the Main Menu, enter the STAT Mode.
2. Input data into the list and draw the linear regression graph.

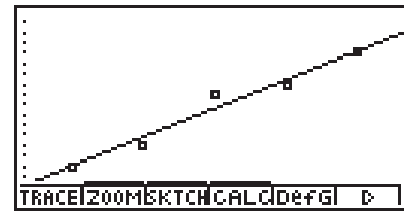

3. From the Main Menu, enter the RUN • MAT Mode.
4. Press the keys as follows.

**2** **0** (value of  $x_i$ )  
**OPTN** **F6** ( $\triangleright$ ) **F4** (STAT) **2** ( $\hat{y}$ ) **EXE**

```
20.0
1008.6
```

The estimated value  $\hat{y}$  is displayed for  $x_i = 20$ .

**1** **0** **0** **0** (value of  $y_i$ )  
**F4** (STAT) **1** ( $\hat{x}$ ) **EXE**

```
20.0
1000.0
4.642857143
```

The estimated value  $\hat{x}$  is displayed for  $y_i = 1000$ .



# You cannot obtain estimated values for a Med-Med, quadratic regression, cubic regression, quartic regression, sinusoidal regression, or logistic regression graph.

## ■ Probability Distribution Calculation

You can calculate probability distributions for single-variable statistics with the RUN•MAT Mode.

Press  $\text{OPTN}$   $\text{F6}$  ( $\triangleright$ )  $\text{F1}$  (PROB) to display a function menu, which contains the following items.

- $\{P\}/\{Q\}/\{R\}$  ... obtains probability  $\{P(t)\}/\{Q(t)\}/\{R(t)\}$  value
  - $\{t\}$  ... {obtains normalized variate  $t(x)$  value}
- Probability  $P(t)$ ,  $Q(t)$ , and  $R(t)$ , and normalized variate  $t(x)$  are calculated using the following formulas.

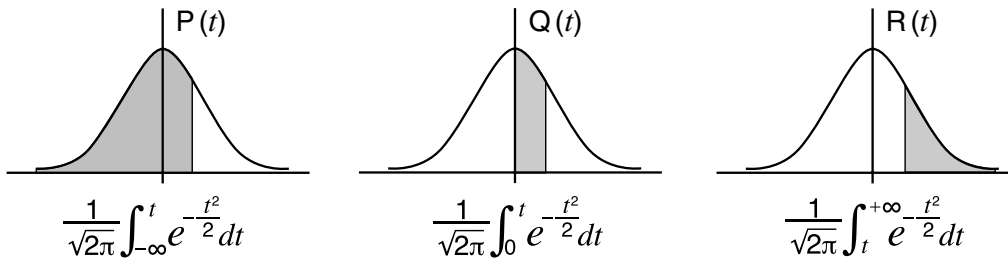

$t(x)$

$$t = \frac{x - \bar{x}}{x\sigma n}$$

● ● ● ● ●

**Example** The following table shows the results of measurements of the height of 20 college students. Determine what percentage of the students fall in the range 160.5 cm to 175.5 cm. Also, in what percentile does the 175.5 cm tall student fall?

| Class no. | Height (cm) | Frequency |
|-----------|-------------|-----------|
| 1         | 158.5       | 1         |
| 2         | 160.5       | 1         |
| 3         | 163.3       | 2         |
| 4         | 167.5       | 2         |
| 5         | 170.2       | 3         |
| 6         | 173.3       | 4         |
| 7         | 175.5       | 2         |
| 8         | 178.6       | 2         |
| 9         | 180.4       | 2         |
| 10        | 186.7       | 1         |



1. Input the height data into List 1 and the frequency data into List 2.
2. Perform the single-variable statistical calculations.\*<sup>1</sup>

**F2**(CALC) **4** (Set)  
**F2**(LIST) **2** **EXE** **ESC**  
**F2**(CALC) **1** (1VAR)

```
1-Variable
x̄ = 172.005
Σx = 3440.1
Σx² = 592706.09
x̄n = 7.04162445
x̄n-1 = 7.22455425
n = 20 ↓
```

3. Press **MENU**, select the RUN • MAT menu, press **OPTN** **F6** (**▷**) **F1** (PROB), and recall the probability calculation (PROB) menu.

**F1**(PROB) **8** (t) **1** **6** **0** **.** **5** **)** **EXE**  
(Normalized variate  $t$  for 160.5cm)

Result: -1.63385948  
(≈ -1.634)

**F1**(PROB) **8** (t) **1** **7** **5** **.** **5** **)** **EXE**  
(Normalized variate  $t$  for 175.5cm)

Result: 0.4963343361  
(≈ 0.496)

**F1**(PROB) **5** (P) **0** **.** **4** **9** **6** **)** **=**  
**F1**(PROB) **5** (P) **(←)** **1** **.** **6** **3** **4** **)** **EXE**  
(Percentage of total)

Result: 0.638921  
(63.9% of total)

**F1**(PROB) **7** (R) **0** **.** **4** **9** **6** **)** **EXE**  
(Percentile)

Result: 0.30995  
(31.0 percentile)



\*<sup>1</sup> You can obtain the normalized variate immediately after performing single-variable statistical calculations only.

---

## ■ Drawing a Probability Distribution Graph

### Description

You can draw a probability distribution graph using manual graphing with the RUN•MAT Mode.

---

### Set Up

- 1. From the Main Menu, enter the RUN•MAT Mode.

### Execution

- 2. Input the commands to draw a rectangular coordinate graph.
- 3. Input the probability value.





**Example** To draw a probability P (0.5) graph.

---

### Procedure

- ① **MENU** RUN • MAT
- ② **OPTN** **F6** ( $\triangleright$ ) **F6** ( $\triangleright$ ) **F2** (SKTCH) **1** (ClS) **EXE**  
**F2** (SKTCH) **4** (GRPH) **1** (Y=)
- ③ **OPTN** **F6** ( $\triangleright$ ) **F1** (PROB) **5** (P()) **0** **.** **5** **EXE**

---

### Result Screen

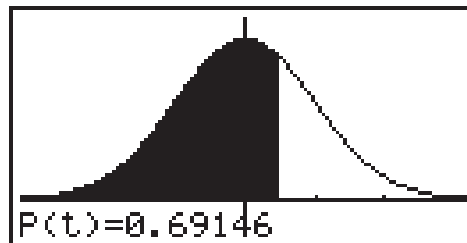





**Chapter**

**7**

**7**

# **Computer Algebra System and Tutorial Modes**

- 7-1 Using the CAS (Computer Algebra System) Mode**
- 7-2 Algebra Mode**
- 7-3 Tutorial Mode**
- 7-4 Algebra System Precautions**

## 7-1 Using the CAS (Computer Algebra System) Mode

On the Main Menu, select the **CAS** icon to enter the CAS Mode.

The following table shows the keys that can be used in the CAS Mode.

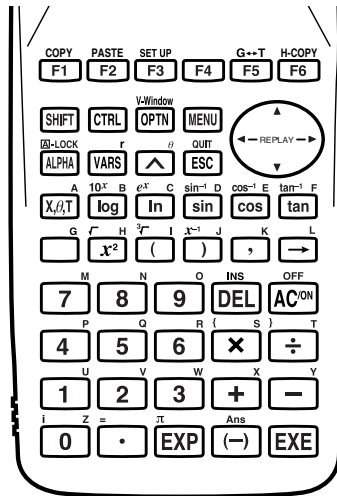

### ■ Inputting and Displaying Data

Input in the Algebra Mode is performed in the upper part of the display, which is called the “input area.” You can input commands and expressions at the current cursor location.



Calculation results appear in the lower part of the display, which is called the “output area.” When a calculation produces an equation or inequality, the lower part of the display is divided between a “natural result display area” for the result, and a “formula number area” for the formula number as shown below.

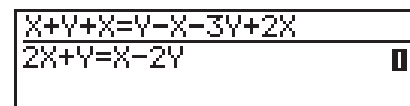

If all the result does not fit on the display, use the cursor keys to scroll it.

```

tExpand(sin (A+B))
cos(B)·sin(A)+sin(B)·c

```

---

## ■ Performing an Algebra Mode Operation

There are two methods that you can use for input in the Algebra Mode.

- Function menu command input
- Manual formula and parameter input

---

## ■ Menu Command Input

Press a function menu key to display the menu of functions for the type of operation you are trying to perform.

- **TRNS** ... {formula transformation menu}
- **CALC** ... {formula calculation menu}
- **EQUA** ... {equation, inequality menu}
- **eqn** ... {calls up an equation stored in Equation Memory in accordance with a specified input value}
- **CLR** ... {variable/formula delete menu}

For details on commands and their formats, see the “Algebra Command Reference” on page 7-1-7.



## Manual Formula and Parameter Input

You can use the function menus, **[OPTN]** key, and **[VARS]** key in combination to input formulas and parameters as described below.

- **[F3]** (EQUA) **[1]** (INEQUA)
  - **{>}/</b>{<}/</b>{≥}/</b>{≤} ... {inequality}**
- **[OPTN]** key
  - **{∞}/</b>{Abs}/</b>{x!}/</b>{sign} ... {infinity}/</b>{absolute value}/</b>{factorial}/</b>{signum function\*1}**
  - **{HYP}** ... {hyperbolic}/</b>{inverse hyperbolic} functions
    - **{sinh}/</b>{cosh}/</b>{tanh}/</b>{sinh<sup>-1</sup>}/</b>{cosh<sup>-1</sup>}/</b>{tanh<sup>-1</sup>}**
- **[VARS]** key
  - **{Y}/</b>{r}/</b>{Xt}/</b>{Yt}/</b>{X} ... input of graph memory {Y}/</b>{r}/</b>{Xt}/</b>{Yt}/</b>{X}**

## Formula Memory

The CAS Mode has 28 formula variables. Variable names are the letters A through Z, plus  $r$ , and  $\theta$ . CAS Mode formula variables are independent of standard value variables.\*2



**Example** To assign a formula that differentiates  $\sin(X)$  at  $X$  ( $\cos(X)$ ) to variable A

**[F2]** (CALC) **[1]** (diff) **[sin]** **[X,θ,T]** **[ ]**  
**[X,θ,T]** **[ )** **[→]** **[ALPHA]** **[X,θ,T]** (A) **[EXE]**

```
diff(sin X,X)→A
cos(X)
```



$${}^*1 \text{signum}(A) \begin{cases} 1 \text{ (real number, } A > 0) \\ -1 \text{ (real number, } A < 0) \\ \frac{A}{|A|} \text{ (} A = \text{imaginary number)} \\ \text{Undefined (} A = 0) \end{cases}$$

\*2 Use the approx command before inputting to register a value to a general variable.  
 Example: approx 1  $\rightarrow$  A



## Function Memory and Graph Memory

Function memory lets you store functions for later recall when you need them.

With graph memory, you can store graphs in memory. Press the **[VARS]** key and then input the name of the graph.



**Example** To differentiate  $f_1 = \cos(X)$ , which is assigned to function memory  $f_1$ , at  $X$

**[F2]** (CALC) **[1]** (diff) **[OPTN]** **[F6]** (FMEM)  
**[3]** (fn) **[1]** **[,]** **[X,θ,T]** **[)]** **[EXE]**

```
diff(fn1,X)
- sin(X)
```



**Example** To differentiate  $Y1 = \cos(X)$ , which is assigned to graph memory  $Y1$ , at  $X$

**[F2]** (CALC) **[1]** (diff)  
**[VARS]** **[F1]** (Y) **[1]** **[,]** **[X,θ,T]** **[)]** **[EXE]**

```
diff(Y1,X)
- sin(X)
```

## Eqn Memory

When a calculation result is an equation or inequality, its formula number is displayed in the formula number area, and the equation is stored in Eqn memory.\*<sup>1</sup> Stored equations can be recalled with the eqn command, rclEqn command or rclAllEqn command.



\*<sup>1</sup>Up to 99 formulas can be stored in Eqn memory.

The error message "Memory ERROR" when you try to store an equation when there are already 99 equations in Eqn memory. When this happens, execute the ALLEQU (Delete All Equations) from the CLR menu.



## ■ Answer (Ans) Memory and Continuous Calculation

Answer (Ans) memory and continuous calculation can be used just as with standard calculations. In the Algebra Mode, you can even store formulas in Ans memory.



**Example** To expand  $(X+1)^2$  and add the result to  $2X$

**[F1]** (TRNS) **[1]** (expand)

**[C]** **[X,θ,T]** **[+]** **[1]** **)** **[x<sup>2</sup>]** **)** **[EXE]**

```
expand((X+1)^2)
X^2+2X+1
```

Continuing:

**[+]** **[2]** **[X,θ,T]** **[EXE]**

```
Ans+2X
X^2+4X+1
```



## ■ Replay Contents

Replay memory can be used in the input area. After a calculation is complete, pressing **[◀]** or **[▶]** in the input area recalls the formula of the last calculation performed. After a calculation or after pressing **[AC]**, you can press **[▲]** or **[▼]** to recall previous formulas.

## ■ Moving the Cursor Between Display Areas

When **[◀]** **[▶]** **[▲]** **[▼]** indicates a calculation result that does not fit on the display, the cursor keys perform output area scrolling. To use the Replay Function from this condition, press **[F6]** (**[▶]**) **[F2]** (SW). **[◀]** **[▶]** **[▲]** **[▼]** change to a dotted line display to indicate that cursor key operations control the input area.

Pressing **[F2]** (SW) again moves the cursor back to the output area.



# Pressing **[F6]** (**[▶]**) **[F1]** (CLR) **[3]** (ALLEQU) deletes Eqn memory, Ans memory, and Replay memory contents.

# You can input up to 255 bytes of data into the input area.

---

## SET UP Items

- **Angle** ... Unit of angular measurement specification
  - {Deg}/{Rad} ... {degrees}/{radians}
- **Answer Type** ... Result range specification
  - {Real}/{Cplx} ... {real number}/{complex number}
- **Display** ... Display format specification (for approx only)
  - {Fix}/{Sci}/{Norm} ... {number of decimal places}/{number of significant digits}/  
{normal display format}

---

## ■ Graph Function

Pressing **F5**(GRPH) displays the graph formula screen. You can execute **F1**(SEL) and **F2**(DEL) from this screen. Pressing **F6**(DRAW) graphs the SET condition expressions.

---

## ■ RECALL ANS Function

Pressing **F6**(▷)**F3**(R•ANS) recalls Ans Memory contents.



## Algebra Command Reference

The following are the abbreviations used in this section.

- **Exp** ... Expression (value, formula, variable, etc.)
- **Eq** ... Equation
- **Ineq** ... Inequality

Anything enclosed within square brackets can be omitted.

### • expand

Function: Expands an expression.

Syntax: `expand ( {Exp/Eq/Ineq} [ ] )`

• • • • •

**Example** To expand  $(X+2)^2$

`[F1] (TRNS) [1] (expand) [C] [X,θ,T] [+ ] [2] [D] [x²] [EXE]`

$$X^2 + 4X + 4$$



### • rFactor (rFctor)

Function: Factors an expression up to its root.

Syntax: `rFactor ( {Exp/Eq/Ineq} [ ] )`

• • • • •

**Example** To factor the  $X^2 - 3$

`[F1] (TRNS) [2] (rFctor) [X,θ,T] [x²] [- ] [3] [EXE]`

$$(X - \sqrt{3}) (X + \sqrt{3})$$

### • factor

Function: Factors an expression.

Syntax: `factor ( {Exp/Eq/Ineq} [ ] )`

• • • • •

**Example** To factor  $X^2 - 4X + 4$

`[F1] (TRNS) [3] (factor) [X,θ,T] [x²] [- ] [4] [X,θ,T] [+ ] [4] [EXE]`

$$(X - 2)^2$$



---

**• solve**

Function: Solves an equation.

Syntax: solve( Exp [,variable] [ ] )

solve( {Exp-1,..., Exp-n}, {variable-1,...,variable-n} [ ] )

• • • • •

**Example** To solve  $AX + B = 0$  for  $X$

**F1**(TRNS) **4** (solve) **ALPHA** **X,θ,T** (A) **X,θ,T** **+**  
**ALPHA** **log** (B) **SHIFT** **□** (=) **0** **EXE**

$$X = \frac{-B}{A}$$

• • • • •

**Example** To solve simultaneous linear equation  $3X + 4Y = 5, 2X - 3Y = -8$

**F1**(TRNS) **4** (solve) **SHIFT** **X** ( { )  
**3** **ALPHA** **+** (X) **+** **4** **ALPHA** **-** (Y) **SHIFT** **□** (=) **5** **□**  
**2** **ALPHA** **+** (X) **-** **3** **ALPHA** **-** (Y) **SHIFT** **□** (=) **(-)** **8**  
**SHIFT** **÷** ( } ) **SHIFT** **X** ( { ) **ALPHA** **+** (X) **□**  
**ALPHA** **-** (Y) **SHIFT** **÷** ( } ) **EXE**

$$X = -1$$

$$Y = 2$$

- X is the default when no variable is specified.

---

**• tExpand (tExpnd)**

Function: Employs the addition theorem to expand a trigonometric function.

Syntax: tExpand( Exp [ ] )

• • • • •

**Example** To employ the addition theorem to expand  $\sin(A+B)$

**F1**(TRNS) **5** (TRIG) **1** (tExpnd)  
**sin** **□** **ALPHA** **X,θ,T** (A) **+** **ALPHA** **log** (B) **EXE**

$$\cos(B) \cdot \sin(A) + \sin(B) \cdot \cos(A)$$

---

**• tCollect (tCollc)**

Function: Employs the addition theorem to transform the product of a trigonometric function to a sum.

Syntax: tCollect( Exp [ ] )

• • • • •

**Example** To employ the addition theorem to transform  $\sin(A)\cos(B)$  to trigonometric sum.

**F1**(TRNS) **5** (TRIG) **2** (tCollc)  
**sin** **ALPHA** **X,θ,T** (A) **cos** **ALPHA** **log** (B) **EXE**

$$\frac{\sin(A+B)}{2} + \frac{\sin(A-B)}{2}$$



---

- **trigToExp (trigToE)**

Function: Transforms a trigonometric or hyperbolic function to an exponential function.

Syntax: trigToExp( Exp [ ] )

• • • • •

**Example** To convert  $\cos(iX)$  to an exponential function

**F1** (TRNS) **5** (TRIG) **3** (trigToE) **cos** **SHIFT** **0** (*i*) **X,θ,T** **EXE**

$$\frac{e^{X} + e^{-X}}{2}$$

---

- **expToTrig (expToT)**

Function: Converts an exponential function to a trigonometric or hyperbolic function.

Syntax: expToTrig( Exp [ ] )

• • • • •

**Example** To convert  $e^{iX}$  to a trigonometric function

**F1** (TRNS) **5** (TRIG) **4** (expToT)

**SHIFT** **In** ( $e^x$ ) **C** **SHIFT** **0** (*i*) **X,θ,T** **EXE**

$$\cos(X) + \sin(X) \cdot i$$

---

- **simplify (smply)**

Function: Simplifies an expression.

Syntax: simplify( {Exp/Eq/Ineq} [ ] )

• • • • •

**Example** To simplify  $2X + 3Y - X + 3 = Y + X - 3Y + 3 - X$

**F1** (TRNS) **6** (smply) **2** **ALPHA** **+** (X) **+** **3** **ALPHA** **=** (Y)

**=** **ALPHA** **+** (X) **+** **3** **SHIFT** **\*** (=) **ALPHA** **=** (Y)

**+** **ALPHA** **+** (X) **=** **3** **ALPHA** **=** (Y) **+** **3** **=**

**ALPHA** **+** (X) **EXE**

$$X + 3Y + 3 = -2Y + 3$$



---

- **combine (combin)**

Function: Reduces a fraction.

Syntax: combine( {Exp/Eq/Ineq} [ ] )

• • • • •

**Example** To reduce the fraction  $(X + 1)/(X + 2) + X(X + 3)$

**F1**(TRNS) **7** (combin) **C** **X,θ,T** **+** **1** **)** **÷**  
**C** **X,θ,T** **+** **2** **)** **+** **X,θ,T** **C** **X,θ,T** **+** **3** **EXE**

$$\frac{X^3 + 5X^2 + 7X + 1}{X + 2}$$

---

- **collect (colct)**

Function: Rearranges an expression, focusing on a particular variable.

Syntax: collect( {Exp/Eq/Ineq} [,Exp-1/, variable] [ ] )

• • • • •

**Example** To rearrange  $X^2 + AX + BX$ , focusing on the variable  $X$

**F1**(TRNS) **8** (colct) **X,θ,T** **x<sup>2</sup>** **+** **ALPHA** **X,θ,T** **(A)** **X,θ,T** **+**  
**ALPHA** **log** **(B)** **X,θ,T** **EXE**

$$X^2 + (A + B)X$$

- $X$  is the default when nothing is specified for [,Exp-1/, variable].

---

- **substitute (sbstit)**

Function: Assigns an expression to a variable.

Syntax: substitute( {Exp/Eq/Ineq}, variable=expression [,..., variable=expression] [ ] )

• • • • •

**Example** To assign 5 to  $X$  in  $2X - 1$

**F1**(TRNS) **9** (sbstit) **2** **X,θ,T** **-** **1** **,**  
**X,θ,T** **SHIFT** **□** (=) **5** **EXE**

9

---

- **cExpand (cExpnd)**

Function: Expands  $x$ th root of imaginary number.

Syntax: cExpand( Exp [ ] )

• • • • •

**Example** To expand  $\sqrt{2i}$

**F1**(TRNS) **X,θ,T** (cExpnd) **SHIFT** **x<sup>2</sup>** (**√**) **2** **SHIFT** **0** (**i**) **EXE**

1 + i



- **approx**

**Function:** Produces a numerical approximation for an expression.

**Syntax:** approx Exp

• • • • •

**Example** To obtain a numerical value for  $\sqrt{2}$

$\boxed{\text{F1}}$  (TRNS)  $\boxed{\text{log}}$  (approx)  $\boxed{\text{SHIFT}}$   $\boxed{x^2}$  ( $\sqrt{\quad}$ )  $\boxed{2}$   $\boxed{\text{EXE}}$

1.414213562

## ■ About approx

Using approx affects the number of digits used to display a calculation result and the way calculations that include variables are performed in the CAS Mode.

With normal calculations (when approx is not used) in the CAS Mode, calculation results are displayed in full, without using exponents. When you use approx in the CAS Mode, however, results are displayed using the exponential format range specified by the Display item of the SET UP screen.

This means approx displays results in the CAS Mode the same way they are displayed in the RUN•MAT Mode.

• • • • •

**Example**  $9^{20}$

Normal:  $\boxed{9}$   $\boxed{\wedge}$   $\boxed{2}$   $\boxed{0}$   $\boxed{\text{EXE}}$

12157665459056928801

approx:  $\boxed{\text{F1}}$  (TRNS)  $\boxed{\text{log}}$  (approx)  $\boxed{9}$   $\boxed{\wedge}$   $\boxed{2}$   $\boxed{0}$   $\boxed{\text{EXE}}$  1.215766546E+19 (Display: Norm1)

If you use approx to execute an expression that contains a variable, the value assigned to the variable in general variable memory (variable memory recalled using RUN•MAT) is used for the calculation.

• • • • •

**Example**  $5A + 3$ , when  $A = 1.3$

Normal:  $\boxed{5}$   $\boxed{\text{ALPHA}}$   $\boxed{\text{X,θT}}$  (A)  $\boxed{+}$   $\boxed{3}$   $\boxed{\text{EXE}}$

$5A + 3$

approx:  $\boxed{\text{F1}}$  (TRNS)  $\boxed{\text{log}}$  (approx)  $\boxed{5}$   $\boxed{\text{ALPHA}}$   $\boxed{\text{X,θT}}$  (A)  $\boxed{+}$   $\boxed{3}$   $\boxed{\text{EXE}}$

9.5



# A Syntax ERROR occurs if a calculation is performed in front of (to the left of) the approx command.

Example:  $1 + \text{approx}(\sqrt{2}) \dots$  Syntax ERROR



---

- **diff**

Function: Differentiates an expression.

Syntax: diff( Exp [, variable, order, derivative] [ ] )

diff( Exp, variable [, order, derivative] [ ] )

diff( Exp, variable, order [, derivative] [ ] )

• • • • •

**Example** To differentiate  $X^6$  with respect to  $X$

**F2** (CALC) **1** (diff) **X,θ,T** **∧** **6** **EXE**

$6X^5$

- $X$  is the default when no variable is specified.
  - 1 is the default when no order is specified.
- 

- **∫**

Function: Integrates an expression.

Syntax: ∫( Exp [, variable, integration constant] [ ] )

∫( Exp, variable [, integration constant] [ ] )

∫( Exp, variable, lower limit, upper limit [ ] )

• • • • •

**Example** To integrate  $X^2$  with respect to  $X$

**F2** (CALC) **2** (∫) **X,θ,T** **x<sup>2</sup>** **EXE**

$\frac{X^3}{3}$

- $X$  is the default when no variable is specified.
- 

- **lim**

Function: Determines the limits of a function expression.

Syntax: lim( Exp, variable, point [, direction] [ ] )

• • • • •

**Example** To determine the limits of  $\sin(X)/X$  when  $X = 0$

**F2** (CALC) **3** (lim) **sin** **X,θ,T** **÷** **X,θ,T** **▸** **X,θ,T** **▾** **0** **EXE**

1

- Direction can be positive (from right) or negative (from left).



---

- $\Sigma$

Function: Calculates a sum.

Syntax:  $\Sigma$ ( Exp, variable, start value, end value [ ] )

• • • • •

**Example** To calculate the sum as the value of X in  $X^2$  changes from X = 1 through X = 10

$\boxed{\text{F2}}$  (CALC)  $\boxed{4}$  ( $\Sigma$ )  $\boxed{\text{X},\theta,\text{T}}$   $\boxed{x^2}$   $\boxed{\text{X},\theta,\text{T}}$   $\boxed{1}$   $\boxed{\text{X},\theta,\text{T}}$   $\boxed{10}$   $\boxed{\text{EXE}}$

385

---

- $\Pi$

Function: Calculates a product.

Syntax:  $\Pi$ ( Exp, variable, start value, end value [ ] )

• • • • •

**Example** To calculate the product as the value of X in  $X^2$  changes from X = 1 through X = 5

$\boxed{\text{F2}}$  (CALC)  $\boxed{5}$  ( $\Pi$ )  $\boxed{\text{X},\theta,\text{T}}$   $\boxed{x^2}$   $\boxed{\text{X},\theta,\text{T}}$   $\boxed{1}$   $\boxed{\text{X},\theta,\text{T}}$   $\boxed{5}$   $\boxed{\text{EXE}}$

14400

---

- **taylor**

Function: Finds a Taylor polynomial.

Syntax: taylor( Exp, variable, order [ , center point ] [ ] )

• • • • •

**Example** To find a 5th order Taylor polynomial for sin(X) with respect to X = 0

$\boxed{\text{F2}}$  (CALC)  $\boxed{6}$  (taylor)  $\boxed{\sin}$   $\boxed{\text{X},\theta,\text{T}}$   $\boxed{\text{X},\theta,\text{T}}$   $\boxed{5}$   $\boxed{\text{X},\theta,\text{T}}$   $\boxed{0}$   $\boxed{\text{EXE}}$

$$\frac{X^5}{120} - \frac{X^3}{6} + X$$

- The default center point is zero.

---

- **arcLen**

Function: Returns the arc length.

Syntax: arcLen( Exp, variable, start value, end value [ ] )

• • • • •

**Example** To determine the arc length for  $X^2$  from X = 0 to X = 1

$\boxed{\text{F2}}$  (CALC)  $\boxed{7}$  (arcLen)  $\boxed{\text{X},\theta,\text{T}}$   $\boxed{x^2}$   $\boxed{\text{X},\theta,\text{T}}$   $\boxed{0}$   $\boxed{\text{X},\theta,\text{T}}$   $\boxed{1}$   $\boxed{\text{EXE}}$

$$\frac{\ln(4\sqrt{5} + 8)}{4} - \frac{\ln(2)}{2} + \frac{\sqrt{5}}{2}$$



---

- **tanLine (tanLin)**

Function: Returns the expression for a tangent line.

Syntax: tanLine( Exp, variable, variable value at point of tangency [ ] )

• • • • •

**Example** To determine the expression for a line tangent with  $X^3$  when  $X = 2$

$\boxed{\text{F2}}$  (CALC)  $\boxed{8}$  (tanLin)  $\boxed{\text{X},\theta,\text{T}}$   $\boxed{\wedge}$   $\boxed{3}$   $\boxed{,}$   $\boxed{\text{X},\theta,\text{T}}$   $\boxed{,}$   $\boxed{2}$   $\boxed{\text{EXE}}$   $12X - 16$

---

- **denominator (den)**

Function: Extracts the denominator of a fraction.

Syntax: denominator( Exp [ ] )

• • • • •

**Example** To extract the denominator of the fraction  $(X + 2)/(Y - 1)$

$\boxed{\text{F2}}$  (CALC)  $\boxed{9}$  (EXTRCT)  $\boxed{1}$  (den)  
 $\boxed{(\text{ALPHA})}$   $\boxed{+}$   $\boxed{\text{X}}$   $\boxed{+}$   $\boxed{2}$   $\boxed{)}$   $\boxed{\div}$   $\boxed{(\text{ALPHA})}$   $\boxed{-}$   $\boxed{\text{Y}}$   $\boxed{-}$   $\boxed{1}$   $\boxed{\text{EXE}}$   $Y - 1$

---

- **numerator (num)**

Function: Extracts the numerator of a fraction.

Syntax: numerator( Exp [ ] )

• • • • •

**Example** To extract the numerator of the fraction  $(X + 2)/(Y - 1)$

$\boxed{\text{F2}}$  (CALC)  $\boxed{9}$  (EXTRCT)  $\boxed{2}$  (num)  
 $\boxed{(\text{ALPHA})}$   $\boxed{+}$   $\boxed{\text{X}}$   $\boxed{+}$   $\boxed{2}$   $\boxed{)}$   $\boxed{\div}$   $\boxed{(\text{ALPHA})}$   $\boxed{-}$   $\boxed{\text{Y}}$   $\boxed{-}$   $\boxed{1}$   $\boxed{\text{EXE}}$   $X + 2$

---

- **gcd**

Function: Returns the greatest common denominator.

Syntax: gcd( Exp, Exp [ ] )

• • • • •

**Example** To determine the greatest common denominator of  $X + 1$  and  $X^2 - 3X - 4$

$\boxed{\text{F2}}$  (CALC)  $\boxed{\text{X},\theta,\text{T}}$  (gcd)  $\boxed{\text{X},\theta,\text{T}}$   $\boxed{+}$   $\boxed{1}$   $\boxed{,}$   $\boxed{\text{X},\theta,\text{T}}$   $\boxed{x^2}$   $\boxed{-}$   
 $\boxed{3}$   $\boxed{\text{X},\theta,\text{T}}$   $\boxed{-}$   $\boxed{4}$   $\boxed{\text{EXE}}$   $X + 1$

---

- **rclEqn**

Function: Recalls multiple eqn memory contents.

Syntax: rclEqn( memory number [ , ..., memory number] [ ] )

• • • • •

**Example** To recall the contents of equation memory 2 and equation memory 3

$\boxed{\text{F3}}$  (EQUA)  $\boxed{2}$  (rclEqn)  $\boxed{2}$   $\boxed{\rightarrow}$   $\boxed{3}$   $\boxed{\text{EXE}}$

$$3X - Y = 7$$

$$3X + 6Y = 63$$

- The memory numbers of equations produced as the result of a recall are not updated.
- 

- **rclAllEqn (rclAll)**

Function: Recall all eqn memory contents.

Syntax: rclAllEqn

- The memory numbers of equations produced as the result of a recall are not updated.
- 

- **rewrite (rewrit)**

Function: Moves the right side element to the left side.

Syntax: rewrite( {Eq/Ineq} [ ] )

• • • • •

**Example** To move the right side element of  $X + 3 = 5X - X^2$  to the left side

$\boxed{\text{F3}}$  (EQUA)  $\boxed{4}$  (rewrit)  $\boxed{\text{X},\theta,\text{T}}$   $\boxed{+}$   $\boxed{3}$   $\boxed{\text{SHIFT}}$   $\boxed{=}$  (=)

$\boxed{5}$   $\boxed{\text{X},\theta,\text{T}}$   $\boxed{-}$   $\boxed{\text{X},\theta,\text{T}}$   $\boxed{x^2}$   $\boxed{\text{EXE}}$

$$X^2 - 4X + 3 = 0$$

---

- **exchange (exchng)**

Function: Exchanges the right-side and left-side elements.

Syntax: exchange( {Eq/Ineq} [ ] )

• • • • •

**Example** Exchange the left-side and right-side elements of  $3 > 5X - 2Y$

$\boxed{\text{F3}}$  (EQUA)  $\boxed{5}$  (exchng)  $\boxed{3}$   $\boxed{\text{F3}}$  (EQUA)  $\boxed{1}$  (INEQUA)  $\boxed{1}$  ( $>$ )

$\boxed{5}$   $\boxed{\text{ALPHA}}$   $\boxed{+}$  (X)  $\boxed{-}$   $\boxed{2}$   $\boxed{\text{ALPHA}}$   $\boxed{-}$  (Y)  $\boxed{\text{EXE}}$

$$5X - 2Y < 3$$





- **eliminate (elim)**

Function: Assigns an expression to a variable.

Syntax: eliminate( {Eq/Ineq} -1, variable, Eq-2 [ ] )

● ● ● ● ●

**Example** To transform  $Y = 2X + 3$  to  $X =$  and then substitute  $2X + 3Y = 5$

$\boxed{F3}$  (EQUA)  $\boxed{6}$  (elim)  $\boxed{2}$   $\boxed{\text{ALPHA}}$   $\boxed{+}$  (X)  $\boxed{+}$   $\boxed{3}$   $\boxed{\text{ALPHA}}$   $\boxed{=}$  (Y)  $\boxed{\text{SHIFT}}$   $\boxed{=}$  (=)

$\boxed{5}$   $\boxed{\text{RIGHT}}$   $\boxed{\text{ALPHA}}$   $\boxed{+}$  (X)  $\boxed{\text{LEFT}}$   $\boxed{\text{ALPHA}}$   $\boxed{=}$  (Y)  $\boxed{\text{SHIFT}}$   $\boxed{=}$  (=)

$\boxed{2}$   $\boxed{\text{ALPHA}}$   $\boxed{+}$  (X)  $\boxed{+}$   $\boxed{3}$   $\boxed{\text{EXE}}$

$4Y - 3 = 5$

- **getRight (getRgt)**

Function: Gets the right-side element.

Syntax: getRight( {Eq/Ineq} [ ] )

● ● ● ● ●

**Example** To extract the right side element of  $Y = 2X^2 + 3X + 5$

$\boxed{F3}$  (EQUA)  $\boxed{7}$  (getRgt)  $\boxed{\text{ALPHA}}$   $\boxed{=}$  (Y)  $\boxed{\text{SHIFT}}$   $\boxed{=}$  (=)

$\boxed{2}$   $\boxed{\text{ALPHA}}$   $\boxed{+}$  (X)  $\boxed{x^2}$   $\boxed{+}$   $\boxed{3}$   $\boxed{\text{ALPHA}}$   $\boxed{+}$  (X)  $\boxed{+}$   $\boxed{5}$   $\boxed{\text{EXE}}$

$2X^2 + 3X + 5$

- **eqn**

Function: Recalls eqn memory contents.

Syntax: eqn( memory number [ ] )

● ● ● ● ●

**Example** To add 15 to both sides of the equation  $6X - 15 = X - 7$ , which is stored in equation memory 3

$\boxed{F4}$  (eqn)  $\boxed{3}$   $\boxed{\text{RIGHT}}$   $\boxed{+}$   $\boxed{1}$   $\boxed{5}$   $\boxed{\text{EXE}}$

$6X = X + 8$



---

- **clear (clrVar)**

Function: Clears the contents of specific equation (A to Z,  $r$ ,  $\theta$ ).<sup>\*1</sup>

Syntax: clear( variable [ ] )

clear( {variable list} [ ] )



**Example** To clear the contents of variable A

**F6** ( $\triangleright$ ) **F1** (CLR) **1** (clrVar) **ALPHA** **X, $\theta$ ,T** (A) **EXE** { }



**Example** To clear the contents of variables X, Y, and Z

**F6** ( $\triangleright$ ) **F1** (CLR) **1** (clrVar) **SHIFT** **X** ( { ) **ALPHA** **+** (X) **,**  
**ALPHA** **=** (Y) **,** **ALPHA** **0** (Z) **SHIFT** **÷** ( } ) **EXE** { }



---

- **clearVarAll (VarAll)**

**Function:** Clears the contents of all 28 variables (A to Z,  $r$ ,  $\theta$ ).

**Syntax:** clearVarAll

{ }



<sup>\*1</sup>When you start out with memories A, B, C, and D, for example, and delete memories A and B, the display shows only C,D because they are the only memories remaining.

## 7-2 Algebra Mode

The CAS Mode automatically provides you with the final result only. The Algebra Mode, on the other hand, lets you obtain intermediate results at a number of steps along the way.

On the Main Menu, select the **ALGEBRA** icon to enter the Algebra Mode. The screens in this mode are the same as those in the CAS Mode.

Operations in the Algebra Mode are identical to those in the CAS Mode, except for a number of limitations. Also, the following commands are available in the Algebra Mode only.

---



---

### • arrange (arrang)

Function: Arranges terms in sequence of their variables.

Syntax: arrange( {Exp/Eq/Ineq} [ ] )

• • • • •

**Example** To arrange  $2X + 3 - 5X + 8Y$  in sequence of its variables

$\boxed{\text{F1}}$  (TRNS)  $\boxed{9}$  (arrang)  $\boxed{2}$   $\boxed{\text{ALPHA}}$   $\boxed{+}$  (X)  $\boxed{+}$   $\boxed{3}$   $\boxed{-}$   
 $\boxed{5}$   $\boxed{\text{ALPHA}}$   $\boxed{+}$  (X)  $\boxed{+}$   $\boxed{8}$   $\boxed{\text{ALPHA}}$   $\boxed{-}$  (Y)  $\boxed{\text{EXE}}$   $- 5X + 2X + 8Y + 3$

---

### • replace (replac)

Function: Replaces a variable with the expression assigned to the corresponding expression variable.

Syntax: replace( {Exp/Eq/Ineq} [ ] )

• • • • •

**Example** To replace **S** in the expression  $3X + 2S$ , when the expression  $2X + 1$  is assigned to **S**

$\boxed{\text{F1}}$  (TRNS)  $\boxed{\text{X,θT}}$  (replac)  $\boxed{3}$   $\boxed{\text{X,θT}}$   $\boxed{+}$   $\boxed{2}$   $\boxed{\text{ALPHA}}$   $\boxed{\text{X}}$  (S)  $\boxed{\text{EXE}}$   $3X + 2(2X + 1)$



- **absExpand (absExp)**

Function: Divides an expression that contains an absolute value into two expressions.

Syntax: absExpand( {Eq/Ineq} [ ] )

• • • • •

**Example** To strip the absolute value from  $|2X - 3| = 9$

**F3** (EQUA) **8** (absExp) **OPTN** **F1** (Abs) **C**

**2** **X,θ,T** **=** **3** **)** **SHIFT** **•** (**=**) **9** **EXE**

$2X - 3 = 9$  **1**

or  $2X - 3 = -9$  **2**



## 7-3 Tutorial Mode

On the Main Menu, select the **TUTOR** icon to enter the Tutorial Mode.

---

### ■ Tutorial Mode Flow

1. Specify the expression type.
2. Define the expression.
3. Specify the solve mode.

---

### ■ Specifying the Expression Type

Entering the Tutorial Mode displays a menu of the following expression types.

- Linear Equation
- Linear Inequality
- Quadratic Equation
- Simul (Simultaneous) Equation

Use the cursor keys to highlight the expression type you want to specify, and then press **EXE**.

This displays a list of formulas for the expression type you select. Move the cursor to the formula you want to use.

In the case of Linear Inequality, press **F4**(TYPE) to select the inequality type.



The following shows the formulas available for each type of expression.

**Linear Equation — 6 Types**

- $AX = B$
- $AX + B = C$
- $A(BX + C) = D(EX + F)$
- $X + A = B$
- $AX + B = CX + D$
- $|AX + B| = C$

**Linear Inequality — 6 × 4 Types**

- $AX \{ > < \geq \leq \} B$
- $AX + B \{ > < \geq \leq \} C$
- $A(BX + C) \{ > < \geq \leq \} D(EX + F)$
- $X + A \{ > < \geq \leq \} B$
- $AX + B \{ > < \geq \leq \} CX + D$
- $|AX + B| \{ > < \geq \leq \} C$

**Quadratic Equation — 5 Types**

- $AX^2 = B$
- $AX^2 + BX + C = 0$
- $AX^2 + BX + C = DX^2 + EX + F$
- $(AX + B)^2 = C$
- $AX^2 + BX + C = D$

**Simul Equation — 10 Types**

- $AX + BY = C$   
 $DX + EY = F$
- $AX + BY + C = 0$   
 $DX + EY + F = 0$
- $AX + BY = C$   
 $Y = DX + E$
- $AX + BY = C$   
 $DX + EY + F = GX + HY + I$
- $AX + BY + C = DX + EY + F$   
 $Y = GX + H$
- $Y = AX + B$   
 $Y = CX + D$
- $AX + BY + C = DX + EY + F$   
 $GX + HY + I = JX + KY + L$
- $AX + BY = C$   
 $DX + EY + F = 0$
- $AX + BY + C = 0$   
 $Y = DX + E$
- $AX + BY + C = 0$   
 $DX + EY + F = GX + HY + I$

Pressing **F6** (EXCH) reverses the left side and right side elements of the expression.



## ■ Defining the Expression

In this step, you specify coefficients and define the expression. You can select any of the three following methods for specifying coefficients.

- **{RAND}** ... {random generation of coefficients}
- **{INPUT}** ... {key input of coefficients}
- **{SMPL}** ... {selection of coefficients from samples}
- **{SEED}** ... {selection of a number from 1 to 99 (specification of the same number displays the same expression)}

**[F1]** (RAND) or **[EXE]** generates random coefficients and defines the expression.

**[F2]** (INPUT) displays the coefficient input screen. Input coefficients, pressing **[EXE]** after each. After you finish inputting all the coefficients, press **[F6]** (EXE) to define the coefficient.

**[F3]** (SMPL) displays a number of preset sample expressions. Highlight the one you want to use and then press **[EXE]** to define it.

Pressing **[F4]** (SEED) displays a number selection screen. When you want to create the same problem on another calculator, specify an appropriate matching number and press **[EXE]**.

No matter what method you use, the expression you define is displayed in the output area.

You can copy an expression to the Graph Mode as a graph function\*<sup>1</sup>.

- **{L•COP}/{R•COP}** ... copy {left side element}/{right side element} as a graph function (Simultaneous Equation Mode\*<sup>2</sup>)
- **{1•COP}/{2•COP}** ... copy {first}/{second} expression as a graph function



\*<sup>1</sup>In the case of an inequality, the inequality symbols are also copied.

\*<sup>2</sup>Simultaneous equations are transformed to the format  $Y = AX + B$  when copied.

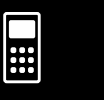

## ■ Specifying the Solve Mode

You can select one of the following three solve modes for the displayed expression.

- **{VRFY}** ... {Verify Mode}

In this mode, you input a solution for verification of whether or not it is correct. It provides a good way to check solutions you arrive at manually.

- **{MANU}** ... {Manual Mode}

In this mode, you manually input algebra commands, transform the expression, and calculate a result.

- **{AUTO}** ... {Auto Mode}

In this mode, the solution is produced automatically, one step at a time.



## ■ Verify Mode

Press **F4**(VRFY) to enter the Verify Mode.

The expression is shown in the top line of the display. Input the solution underneath it, and then press **F6**(JUDG) to determine whether the solution is correct.

The verification result screen shows the left side and right side verification result (except for a linear equation).

- However, in the case where a linear equation or quadratic equation has two solutions, the left side and right side are obtained for the value where the pointer is located.
- In the case of simultaneous equations where the left side and right side of the second equation are dissimilar even though the left side and right side of the first equation match, the left side and right side of the second equation only are obtained. In other cases, the left side and right side of the first equation are obtained.

The type of solution input screen that appears is selected according to the expression type. To input a different type, press **F1**(TYPE) and then select the solution type you want to use. Available solution types depend on the mode.

- **{X = a}** ... X has one solution ( $X = a$ ) (linear equation default)
- **{X = a, b}** ... X has two solutions ( $X = a, X = b$ ) (quadratic equation default)
- **{X = a, Y =}** ... X and Y have one solution each ( $X = a, Y = b$ ) (simultaneous equation default)
- **{X > a}** ...  $X \{ > < \geq \leq \} a$  (linear inequality default)
- **{X < a, b <}** ...  $X < a, b < X$  or  $X \leq a, b \leq X$
- **{a < X < b}** ...  $a < X < b, a \leq X \leq b$  or  $X = a$
- **{Identi}** (**Identity**) ... identity of left side and right side
- **{Many}** (**Many Solutions**) ... many solutions
- **{No sol}** (**No Solution**) ... no solution



You can press **F4** (MANU) to change to the Manual Mode or **F5** (AUTO) to change to the Auto Mode.



**Example To solve  $4X = 8$  in the Verify Mode**

(Linear Equation)( $AX = B$ )

**F2** (INPUT) **4** **EXE** **8** **EXE** **F6** (EXE)

**F4** (VRFY) **2** **EXE**

**F6** (JUDG)



4X=8  
X=2

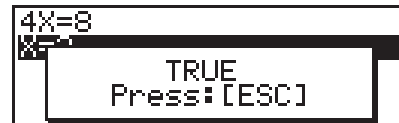

4X=8  
X=2  
TRUE  
Press:[ESC]

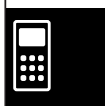

## Manual Mode

Press **F5**(MANU) to enter the Manual Mode.

As with the Algebra Mode, the screen is divided between an input area and a display area. This means you can select Algebra Mode commands from the function menu, transform the expression, and solve it.

Operation is the same as that in the Algebra Mode.

After you obtain a result, you can press **F5**(JUDG) to determine whether or not it is correct.

- **{DISP}** ... Determines whether the expression in the display area is a correct solution.
- **{Indenti}** ... identity of left side and right side
- **{Many}** ... many solutions
- **{No sol}** ... no solution

You can press **F6**(AUTO) to change to the Auto Mode.

• • • • •

**Example Solve  $4X = 8$  in the Manual Mode**

(Linear Equation)( $AX=B$ )

**F2** (INPUT) **4** **EXE** **8** **EXE** **F6** (EXE)

**F5** (MANU)

```
rcLEqn(1)
4X=8
```

**F4** (eqn) **1** **)** **÷** **4**

**EXE**

```
eqn(1)/4
4X_8
4 4
```

**F1** (TRNS) **1** (smpfy)

**F4** (eqn) **2**

**EXE**

```
simplify(eqn(2)
X=2
```

**F5** (JUDG) **1** (DISP)

```
simplify(eqn(2)
X=
TRUE
Press:[ESC]
```





**Example**      $4X^2 = 16$   
                  True ( $X = 2, X = -2$ )

Besides “TRUE” the messages shown below can also appear as the result of verification. “CAN NOT JUDGE” appears in the Manual Mode, while the other messages appear in both the Verify Mode and Manual Mode.

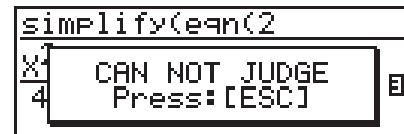
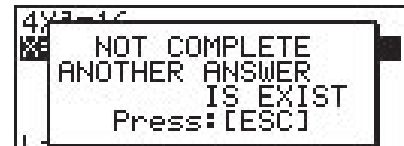

• **andConnect (andCon)**

Function: Connects two inequalities into a single expression.

Syntax: andConnect( Ineq-1, Ineq-2 [ ] )



**Example**     To combine  $X > -1$  and  $X < 3$  into a single inequality

$\boxed{F2}$  (EQUA)  $\boxed{6}$  (andCon)  $\boxed{X,0,T}$   $\boxed{F2}$  (EQUA)  $\boxed{1}$  (INEQUA)  $\boxed{1}$  ( $>$ )

$\boxed{\leftarrow}$   $\boxed{1}$   $\boxed{\rightarrow}$   $\boxed{X,0,T}$   $\boxed{F2}$  (EQUA)  $\boxed{1}$  (INEQUA)  $\boxed{2}$  ( $<$ )  $\boxed{3}$   $\boxed{EXE}$

$-1 < X < 3$

## Auto Mode

Press **F6**(AUTO) to enter the Auto Mode.

In the Simultaneous Equation Mode, you must also select SBSTIT (Substitution Method) or ADD-SU (Addition/Subtraction Method).

The Substitution Method first transforms the equation to the format  $Y = aX + b$ , and substitutes the other expression to  $Y$ .<sup>\*1</sup>

The Addition/Subtraction Method multiplies both sides of the expression by the same value to isolate the coefficient  $X$  (or  $Y$ ).

As with the Algebra Mode, the screen is divided between an input area and a display area.

Each press of **F6**(NEXT) advances to the next step. **F6**(NEXT) is not shown on the display when after the solution is obtained.

You can scroll back through the steps by pressing **F1**(BACK).



### Example To solve $4X = 8$ in the Auto Mode

(Linear Equation)( $AX = B$ )

**F2** (INPUT) **4** **EXE** **8** **EXE** **F6** (EXE)

**F6** (AUTO)

```
rcLEqn(1)
4X=8
BACK NEXT
```

**F6** (NEXT)

```
eqn(1)/4
4X=8
4 4
```

**F6** (NEXT)

```
simplify(eqn(2))
X=2
```



<sup>\*1</sup>You can press **F5**(ADD SU) at any time to switch from Substitution Method to Addition / Subtraction Method.

# See 7-1-6 for information about graph functions.

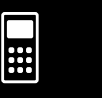

## 7-4 Algebra System Precautions

- If an algebraic operation cannot be performed for some reason, the original expression remains on the display.
- It may take considerable time to perform an algebraic operation. Failure of a result to appear immediately does not indicate malfunction of the computer.
- Any expression can be displayed in various different formats. Because of this, you should not assume that an expression is wrong just because it does not appear as you expected.
- This calculator performs integration calculations under the assumption that integrals are always positive, even when the integrals are discontinuous (due to a switch between positive and negative).

$$\begin{cases} f(x) \\ F(x): \text{primitive function of } f(x) \end{cases}$$

$$\int_a^b f(x)dx = F(b) - F(a)$$





# Chapter 8



## Programming

8

- 8-1 Basic Programming Steps
- 8-2 Program Mode Function Keys
- 8-3 Editing Program Contents
- 8-4 File Management
- 8-5 Command Reference
- 8-6 Using Calculator Functions in Programs
- 8-7 Program Mode Command List
- 8-8 Program Library

This unit comes with approximately 144 kbytes of memory.

- You can check how much memory has been used and how much remains by entering the SYSTEM Mode from the Main Menu, and then pressing **F1** (Mem). See “9-2 Memory Operations” for details.

## 8-1 Basic Programming Steps

### Description

Commands and calculations are executed sequentially, just like manual calculation multistatements.

### Set Up

1. From the Main Menu, enter the PRGM Mode. When you do, a program list appears on the display.

Selected program area  
(use  $\blacktriangle$  and  $\blacktriangledown$  to move)

| Program List                                      |   |   |    |
|---------------------------------------------------|---|---|----|
| AREA                                              | * | : | 34 |
| GRAPHICS                                          | : | : | 56 |
| MEASURE                                           | : | : | 66 |
| OCTA                                              | : | : | 44 |
| OCTONARY                                          | : | : | 89 |
| TRIANGLE                                          | : | : | 69 |
| EXE IEDITNEW   DEL   DELA   $\blacktriangleright$ |   |   |    |

Files are listed in the alphabetic sequence of their names.

### Execution

2. Register a file name.
3. Input the program.
4. Run the program.



# If there are no programs stored in memory when you enter the PRGM Mode, the message “**No Programs**” appears on the display and only the NEW item (**F3**) is shown in the function menu.

# The values to the right of the program list indicate the number of bytes used by each program.

# A file name can be up to eight characters long.

# The following are the characters you can use in a file name:

A through Z,  $r$ ,  $\theta$ , spaces, [ , ] , { , } , ' , " , ~ ,  
0 through 9 , . , + , - ,  $\times$  ,  $\div$

# Registering a file name uses 24 bytes of memory.

# The file name input screen remains on the display if you press **EXE** without inputting a file name.

# To exit the file name input screen and return to the program list without registering a file name, press **ESC**.







**Example 1** To calculate the surface area (cm<sup>2</sup>) and volume (cm<sup>3</sup>) of three regular octahedrons when the length of one side is 7, 10, and 15 cm

Store the calculation formula under the file name OCTA.

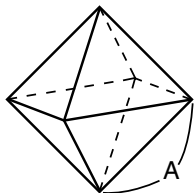

The following are the formulas used for calculating surface area S and volume V of a regular octahedron for which the length of one side A is known.

$$S = 2\sqrt{3}A^2, \quad V = \frac{\sqrt{2}}{3}A^3$$

### Procedure

- ① **MENU** PRGM
- ② **F3** (NEW) **O** **C** **T** **A** **EXE** \*1
- ③ **SHIFT** **VAR**S (PRGM) **F3** (?) **→** **ALPHA** **X,θ,T** (A) **F6** (▷) **F6** (▷) **F3** (:)\*2  
**2** **X** **SHIFT** **x<sup>2</sup>** ( $\sqrt{\quad}$ ) **3** **X** **ALPHA** **X,θ,T** (A) **x<sup>2</sup>** **F6** (▷) **F4** (▲)  
**SHIFT** **x<sup>2</sup>** ( $\sqrt{\quad}$ ) **2** **÷** **3** **X** **ALPHA** **X,θ,T** (A) **∧** **3**  
**ESC** **ESC**

- ④ **F1** (EXE) or **EXE**  
**7** **EXE** (Value of A)  
**EXE**

|              |             |
|--------------|-------------|
| ?            |             |
| 7            |             |
| S when A = 7 | 169.7409791 |
| V when A = 7 | 161.6917506 |

- EXE**  
**EXE** **1** **0** **EXE**  
**EXE**

|               |             |
|---------------|-------------|
| ?             |             |
| 10            |             |
| S when A = 10 | 346.4101615 |
| V when A = 10 | 471.4045208 |

- EXE**  
**EXE** **1** **5** **EXE**  
**EXE** \*3

|               |             |
|---------------|-------------|
| ?             |             |
| 15            |             |
| S when A = 15 | 779.4228634 |
| V when A = 15 | 1590.990258 |



\*1 Press **F3** (NEW) and the cursor changes form to indicate alpha character input.

\*2 The following shows how the calculation of the surface area and volume of a regular octahedron would be calculated using a manual calculation.

Surface Area S ... **2** **X** **SHIFT** **x<sup>2</sup>** ( $\sqrt{\quad}$ ) **3** **X**  
 <value of A> **x<sup>2</sup>** **EXE**  
 Volume V ..... **SHIFT** **x<sup>2</sup>** ( $\sqrt{\quad}$ ) **2** **÷** **3** **X**  
 <value of A> **∧** **3** **EXE**

\*3 Pressing **EXE** while the final result of a program is on the display changes to the program list.

# You can also run a program while in the **RUN•MAT Mode** by inputting: Prog "<file name>" **EXE**.

# Pressing **EXE** while the final result of a program executed using this method is on the display re-executes the program.

# An error occurs if the program specified by Prog "<file name>" cannot be found.

## 8-2 Program Mode Function Keys

- {NEW} ... {new program}

---

### • When you are registering a file name

- {RUN}/{BASE} ... {general calculation}/{number base} program input
- {n0} ... {password registration}
- {SYBL} ... {symbol menu}

---

### • When you are inputting a program — **F1**(RUN) ... default

- {JUMP} ... {top}/{bottom} of program
- {SRC} ... {search}
- {MAT}/{STAT}/{LIST}/{GRPH}/{DYNA}/{RECR}  
... {matrix}/{statistic}/{list}/{graph}/ {Dynamic Graph}/{recursion} menu
- Pressing **SHIFT** **VAR** (PRGM) displays the following PRGM (PROGRAM) menu.
  - {Prog} ... {program recall}
  - {JUMP} ... {jump command menu}
  - {?}/{▲} ... {input}/{output} command
  - {I/O} ... {I/O control/transfer command menu}
  - {IF}/{FOR}/{WHLE}/{CTRL}/{LOGIC}  
... {conditional jump}/{loop control}/{conditional loop control}/{program control}/  
{logical operation} command menu
  - {CLR}/{DISP} ... {clear}/{display} command menu
  - {:} ..... {separator for expressions and commands}

See “8-5 Command Reference” for full details on each of these commands.

- Pressing **CTRL** **F3** (SET UP) displays the mode command menu shown below.

- {ANGL}/{DISP}/{CPLX}/{GRPH}/{STAT}/{DERIV}/{T-VAR}/{Σ DSP}

See “SET UP Screen Function Key Menus” on page 1-7-1 for details about each of these commands.



---

- When you are inputting a program — **F2**(BASE)\*<sup>1</sup>

- **{JUMP}/{SRC}**
  - **{d~o}** ... {decimal}/{hexadecimal}/{binary}/{octal} value input
  - **{LOG}** ... {logical operators}
  - **{DISP}** ... conversion of displayed value to {decimal}/{hexadecimal}/{binary}/{octal}
  - **{SYBL}** ... {symbol menu}
- Pressing **SHIFT** **VAR** (PRGM) displays the following PRGM (PROGRAM) menu.
    - **{Prog}/{JUMP}/{?}/{▲}**
    - **{= ≠ <}** ... {logical operator menu}
    - **{:}** ..... {separator for expressions and commands}
  - Pressing **CTRL** **F3** (SET UP) displays the mode command menu shown below.
    - **{Dec}/{Hex}/{Bin}/{Oct}**

- 
- **{EXE}/{EDIT}**  
... program {execute}/{edit}
  - **{NEW}** ... {new program}
  - **{DEL}/{DEL-A}**  
... {specific program}/{all program} delete
  - **{SRC}/{REN}**  
... file name {search}/{change}



\*<sup>1</sup>Programs input after pressing **F2**(BASE) are indicated by **B** to the right of the file name.



## 8-3 Editing Program Contents

### ■ Debugging a Program

A problem in a program that keeps the program from running correctly is called a “bug,” and the process of eliminating such problems is called “debugging.” Either of the following symptoms indicates that your program contains bugs that require debugging.

- Error messages appearing when the program is run
- Results that are not within your expectations

#### • To eliminate bugs that cause error messages

An error message, like the one shown below, appears whenever something illegal occurs during program execution.

```
Ma ERROR
Press: [ESC]
```

When such a message appears, press **[ESC]** to display the place in the program where the error was caused. The cursor will be flashing at the location of the problem. Check the “Error Message Table” (page α-1-1) for steps you should take to correct the situation.

- Note that pressing **[ESC]** does not display the location of the error if the program is password protected. Instead, it returns to the program list screen.

#### • To eliminate bugs that cause bad results

If your program produces results that are not what you normally expect, check the contents of the program and make necessary changes.

The **[F1]**(JUMP) **[1]** (Top) key is also useful when editing program contents.

**[F1]**(JUMP) **[1]** (Top) ..... Moves the cursor to the top of the program

```
=====OCTA=====
?→A: 2×√3×A²,
√2/3×A³
```

**[F1]**(JUMP) **[2]** (Bottom)... Moves the cursor to the bottom of the program

```
=====OCTA=====
?→A: 2×√3×A²,
√2/3×A³
```



## ■ Using an Existing Program to Create a New Program

Sometimes you can input a new program by using a program already in memory as a base. Simply recall the existing program, make the changes you need, and then execute it.



**Example 2** To use the OCTA program (page 8-1-2) to create a program that calculates the surface area (cm<sup>2</sup>) and volume (cm<sup>3</sup>) of regular tetrahedrons when the length of one side is 7, 10, and 15 cm  
Use TETRA as the file name.

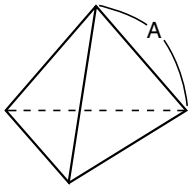

The following are the formulas used for calculating surface area S and volume V of a regular tetrahedron for which the length of one side A is known.

$$S = \sqrt{3} A^2, \quad V = \frac{\sqrt{2}}{12} A^3$$

Use the following key operations when inputting the program.

Length of One Side A ..  $\boxed{\text{SHIFT}} \boxed{\text{VARS}} (\text{PRGM}) \boxed{\text{F3}} (?) \boxed{\rightarrow} \boxed{\text{ALPHA}} \boxed{\text{X,}\theta\text{T}} (A) \boxed{\text{F6}} (\triangleright) \boxed{\text{F6}} (\triangleright) \boxed{\text{F3}} (:)$

Surface Area S .....  $\boxed{\text{SHIFT}} \boxed{x^2} (\sqrt{\quad}) \boxed{3} \boxed{\times} \boxed{\text{ALPHA}} \boxed{\text{X,}\theta\text{T}} (A) \boxed{x^2} \boxed{\text{F6}} (\triangleright) \boxed{\text{F4}} (\blacktriangle)$

Volume V .....  $\boxed{\text{SHIFT}} \boxed{x^2} (\sqrt{\quad}) \boxed{2} \boxed{\div} \boxed{1} \boxed{2} \boxed{\times} \boxed{\text{ALPHA}} \boxed{\text{X,}\theta\text{T}} (A) \boxed{\wedge} \boxed{3}$

Compare this with the program for calculating the surface area and volume of a regular octahedron.

Length of One Side A ..  $\boxed{\text{SHIFT}} \boxed{\text{VARS}} (\text{PRGM}) \boxed{\text{F3}} (?) \boxed{\rightarrow} \boxed{\text{ALPHA}} \boxed{\text{X,}\theta\text{T}} (A) \boxed{\text{F6}} (\triangleright) \boxed{\text{F6}} (\triangleright) \boxed{\text{F3}} (:)$

Surface Area S .....  $\boxed{2} \boxed{\times} \boxed{\text{SHIFT}} \boxed{x^2} (\sqrt{\quad}) \boxed{3} \boxed{\times} \boxed{\text{ALPHA}} \boxed{\text{X,}\theta\text{T}} (A) \boxed{x^2} \boxed{\text{F6}} (\triangleright) \boxed{\text{F4}} (\blacktriangle)$

Volume V .....  $\boxed{\text{SHIFT}} \boxed{x^2} (\sqrt{\quad}) \boxed{2} \boxed{\div} \underline{\boxed{3}} \boxed{\times} \boxed{\text{ALPHA}} \boxed{\text{X,}\theta\text{T}} (A) \boxed{\wedge} \boxed{3}$

As you can see, you can produce the TETRA program by making the following changes in the OCTA program.

- Deleting  $\boxed{2} \boxed{\times}$  (underlined using a wavy line above)
- Changing  $\underline{\boxed{3}}$  to  $\boxed{1} \boxed{2}$  (underlined using a solid line above)



Now edit OCTA to produce the TETRA program.

1. Edit the program name.

**F6**(▷) **F2**(REN) **AC** **T** **E** **T** **R** **A** **EXE**

```
Program List
TETRA      : 44↑
TRIANGLE   : 69
```

2. Edit the program contents.

**F2**(EDIT)

```
====TETRA====
?→A:2×√3×A²,
√2/3×A³
```

▶ ▶ ▶ ▶ **DEL** **DEL**

▼ ◀ **DEL** **1** **2**

```
====TETRA====
?→A:√3×A²,
√2/12×A³
```

**ESC**

3. Try running the program.

**F1**(EXE) or **EXE**

**7** **EXE** (Value of A)

**EXE**

```
?
7
84.87048957
40.42293766
```

**EXE**

**EXE** **1** **0** **EXE**

**EXE**

```
?
10
173.2050808
117.8511302
```

**EXE**

**EXE** **1** **5** **EXE**

**EXE**

```
?
15
389.7114317
397.7475644
```



## ■ Searching for Data Inside a Program



**Example** To search for the letter “A” inside the program named OCTA

1. Recall the program.
2. Press **F2** (SRC) or **EXE** and input the data you want to find.

**F2** (SRC)  
**ALPHA** **X.θT** (A)

```
=====OCTA=====
?→A: 2×√3×A²,
√2/3×A³
```

```
Search For Text
-----
AC
-----
MAT|STAT|LIST|GRPH|DYN|RECR|
```

3. Press **EXE** to begin the search. The contents of the program appears on the screen with the cursor located at the first instance of the data you specified.\*1

```
=====OCTA=====
?→A: 2×√3×A²,
√2/3×A³
SRC |
```

4. Each press of **EXE** or **F1** (SRC) causes the cursor to jump to the next instance of the data you specified.\*2

```
=====OCTA=====
?→A: 2×√3×A²,
√2/3×A³
```



\*1 The message “**Not Found**” appears when the search data you specify cannot be found in the program.

\*2 If there are no more instances of the data you specified, the search operation ends and the cursor returns to the point from which you started your search.

# You cannot specify the newline symbol (↵) or display command (▲) for the search data.

# Once the contents of the program are on the screen, you can use the cursor keys to move the cursor to another location before searching for the next instance of the data. Only the part of the program starting from the current cursor location is searched when you press **EXE**.

# Once the search finds an instance of your data, inputting characters or moving the cursor causes the search operation to be cancelled.

# If you make a mistake while inputting characters to search for, press **AC** to clear your input and re-input from the beginning.



## 8-4 File Management

### ■ Searching for a File

#### • To find a file using initial character search



**Example** To use initial character search to recall the program named OCTA

1. While the program list is on the display, press **F6**(▷) **F1**(SRC) and input the initial characters of the file you want to find.

**F6**(▷) **F1**(SRC)  
**O** **C** **T**

```
Search For Program  
[OCTA]
```

2. Press **EXE** to search.

```
Program List  
OCTA : 44↑  
OCTONARY : 89  
TRIANGLE : 69
```

- The name that starts with the characters you input highlights.



# If there is no program whose file name starts with the characters you input, the message





“**Not Found**” appears on the display. If this happens, press **ESC** to clear the error message.



## ■ Editing a file name



**Example** To change the name of a file from TRIANGLE to ANGLE

1. While the program list is on the display, use  and  to move the highlighting to the file whose name you want to edit and then press  ()  (REN).

```
Rename  
[ TRIANGLE ]
```

2. Make any changes you want.

```
Rename  
[ ANGLE ]
```





3. Press  to register the new name and return to the program list.

The program list is resorted according to the changes you made in the file name.

## ■ Deleting a Program





### • To delete a specific program

1. While the program list is on the display, use  and  to move the highlighting to the name of the program you want to delete.
2. Press  (DEL).
3. Press  (Yes) to delete the selected program or  (No) to abort the operation without deleting anything.



# If the modifications you make result in a file name that is identical to the name of a program already stored in memory, the message “**Already Exists**” appears. When this happens, you can perform either of the following two operations to correct the situation.

- Press  to clear the error and return to the file name editing screen.
- Press  to clear the input file name and input a new one.

### • To delete all programs

1. While the program list is on the display, press **[F5]** (DEL·A).
  2. Press **[EXE]** (Yes) to delete all the programs in the list or **[ESC]** (No) to abort the operation without deleting anything.
- You also can delete all programs by entering the SYSTEM Mode from the Main Menu, and then pressing **[F1]** (Mem) to display the memory management screen. See “9-2 Memory Operations” for details.

### ■ Registering a password

When inputting a program, you can protect it with a password that limits access to the program contents to those who know the password.

- You do not need to input the password to run a program.



**Example** To create a program file under the name AREA and protect it with the password CASIO

1. While the program list is on the display, press **[F3]** (NEW) and input the file name of the new program file.

**[F3]** (NEW)  
**[A]** **[R]** **[E]** **[A]**

```
Program Name  
[AREA& ]
```

2. Press **[F5]** ( $\pi$ 0) and then input the password.

**[F5]** ( $\pi$ 0)  
**[C]** **[A]** **[S]** **[I]** **[O]**

```
Program Name  
[AREA  
Password?  
[CASIO& ]
```



# The password input procedure is identical to that used for file name input.



3. Press **[EXE]** to register the file name and password. Now you can input the contents of the program file.
4. After inputting the program, press **[SHIFT] [ESC]** (QUIT) to exit the program file and return to the program list. Files that are password protected are indicated by an asterisk to the right of the file name.

```
Program List
AREA * : 34
GRAPHICS : 56
```

## ■ Recalling a Password Protected Program



**Example** To recall the file named AREA which is protected by the password CASIO

1. In the program list, use **[▲]** and **[▼]** to move the highlighting to the name of the program you want to recall.

2. Press **[F2]** (EDIT).

```
Program Name
[AREA ]
Password?
[CA ]
```

3. Input the password and press **[EXE]** to recall the program.



# Pressing **[EXE]** without inputting a password while saving a new program causes the file to be saved without a password. Pressing **[EXE]** without inputting a password registers the file name only, without a password.

# Inputting the wrong password when recalling a password protected program causes the message "Mismatch" to appear. Press **[ESC]** to return to the password input screen.



## 8-5 Command Reference

### ■ Command Index

|                                                |        |
|------------------------------------------------|--------|
| Break .....                                    | 8-5-6  |
| ClrGraph .....                                 | 8-5-11 |
| ClrList .....                                  | 8-5-11 |
| ClrText .....                                  | 8-5-12 |
| ClrMat .....                                   | 8-5-12 |
| DispF-Tbl, DispR-Tbl .....                     | 8-5-12 |
| Do~LpWhile .....                               | 8-5-5  |
| DrawDyna .....                                 | 8-5-12 |
| DrawFTG-Con, DrawFTG-Plt .....                 | 8-5-13 |
| DrawGraph .....                                | 8-5-13 |
| DrawR-Con, DrawR-Plt .....                     | 8-5-13 |
| DrawR $\Sigma$ -Con, DrawR $\Sigma$ -Plt ..... | 8-5-14 |
| DrawStat .....                                 | 8-5-14 |
| DrawWeb .....                                  | 8-5-14 |
| Dsz .....                                      | 8-5-9  |
| For~To~(Step~)Next .....                       | 8-5-4  |
| Getkey .....                                   | 8-5-15 |
| Goto~Lbl .....                                 | 8-5-10 |
| If~Then~(Else~)IfEnd .....                     | 8-5-4  |
| Isz .....                                      | 8-5-11 |
| Locate .....                                   | 8-5-16 |
| Prog .....                                     | 8-5-7  |
| Receive (/ Send ( .....                        | 8-5-17 |
| Return .....                                   | 8-5-8  |
| Stop .....                                     | 8-5-8  |
| While~WhileEnd .....                           | 8-5-6  |
| ? (Input Command) .....                        | 8-5-2  |
| ▲ (Output Command) .....                       | 8-5-3  |
| : (Multi-statement Command) .....              | 8-5-3  |
| ↵ (Carriage Return) .....                      | 8-5-3  |
| ' (Comment Text Delimiter) .....               | 8-5-3  |
| =, ≠, >, <, ≥, ≤ (Relational Operators) .....  | 8-5-18 |



The following are conventions that are used in this section when describing the various commands.

- Boldface Text** ..... Actual commands and other items that always must be input are shown in boldface.
- {Curly Brackets}** ..... Curly brackets are used to enclose a number of items, one of which must be selected when using a command. Do not input the curly brackets when inputting a command.
- [Square Brackets]** ..... Square brackets are used to enclose items that are optional. Do not input the square brackets when inputting a command.
- Numeric Expressions**... Numeric expressions (such as 10, 10 + 20, A) indicate constants, calculations, numeric constants, etc.
- Alpha Characters** ..... Alpha characters indicate literal strings (such as AB).

---

## ■ Basic Operation Commands

### ? (Input Command)

**Function:** Prompts for input of values for assignment to variables during program execution.

**Syntax:** ? → <variable name>, "<prompt>" ? → <variable name>

**Example:** ? → A

**Description:**

- This command momentarily interrupts program execution and prompts for input of a value or expression for assignment to a variable. If you do not specify a prompt, execution of this command causes "?" to appear indicating the calculator is standing by for input. If a prompt is specified, "<prompt>?" appears to prompt input. There is no limit to the number of characters that can be specified for a prompt.
- Input in response to the input command must be a value or an expression, and the expression cannot be a multi-statement.



### ▲ (Output Command)

**Function:** Displays an intermediate result during program execution.

**Description:**

- This command momentarily interrupts program execution and displays alpha character text or the result of the calculation immediately before the command.
- The output command should be used at locations where you would normally press the  key during a manual calculation.

### : (Multi-statement Command)

**Function:** Connects two statements for sequential execution without stopping.

**Description:**

- Unlike the output command (▲), statements connected with the multi-statement command are executed non-stop.
- The multi-statement command can be used to link two calculation expressions or two commands.
- You can also use a carriage return indicated by ↵ in place of the multi-statement command.

### ↵ (Carriage Return)

**Function:** Connects two statements for sequential execution without stopping.

**Description:**

- Operation of the carriage return is identical to that of the multi-statement command.
- Using a carriage return in place of the multi-statement command makes the displayed program easier to read.

### ' (Comment Text Delimiter)

**Function:** Indicates comment text inserted inside a program.

**Description:** Anything following the apostrophe is treated as non-executable comment text.



## ■ Program Commands (COM)

### If~Then~(Else~)IfEnd

**Function:** The Then-statement is executed only when the If-condition is true (non-zero). The Else-statement is executed when the If-condition is false (0). The IfEnd-statement is always executed following either the Then-statement or Else-statement.

**Syntax:**

$$\text{If } \underbrace{\text{<condition>}}_{\text{numeric expression}} \left. \begin{array}{c} \left\{ \begin{array}{c} \leftarrow \\ : \\ \blacktriangle \end{array} \right\} \end{array} \right\} \text{ Then } \text{<statement>} \left[ \begin{array}{c} \left\{ \begin{array}{c} \leftarrow \\ : \\ \blacktriangle \end{array} \right\} \\ \text{<statement>} \end{array} \right]$$

$$\left. \begin{array}{c} \left\{ \begin{array}{c} \leftarrow \\ : \\ \blacktriangle \end{array} \right\} \end{array} \right\} \left( \text{Else } \text{<statement>} \left[ \begin{array}{c} \left\{ \begin{array}{c} \leftarrow \\ : \\ \blacktriangle \end{array} \right\} \\ \text{<statement>} \end{array} \right] \left. \begin{array}{c} \left\{ \begin{array}{c} \leftarrow \\ : \\ \blacktriangle \end{array} \right\} \\ \text{IfEnd} \end{array} \right)$$

**Parameters:** condition, numeric expression

**Description:**

(1) If ~ Then ~ IfEnd

- When the condition is true, execution proceeds with the Then-statement and then continues with the statement following IfEnd.
- When the condition is false, execution jumps to the statement following IfEnd.

(2) If ~ Then ~ Else ~ IfEnd

- When the condition is true, execution proceeds with the Then-statement and then jumps to the statement following IfEnd.
- When the condition is false, execution jumps to the Else-statement and then continues with the statement following IfEnd.

### For~To~(Step~)Next

**Function:** This command repeats everything between the For-statement and the Next-statement. The starting value is assigned to the control variable with the first execution, and the value of the control variable is changed according to the step value with each execution. Execution continues until the value of the control variable exceeds the ending value.

**Syntax:**

$$\text{For } \text{<starting value>} \rightarrow \text{<control variable name>} \text{ To } \text{<ending value>} \left( \text{Step } \text{<step value>} \right) \left. \begin{array}{c} \left\{ \begin{array}{c} \leftarrow \\ : \\ \blacktriangle \end{array} \right\} \end{array} \right\}$$

Next

**Parameters:**

- control variable name: A to Z
- starting value: value or expression that produces a value (i.e. sin  $x$ , A, etc.)
- ending value: value or expression that produces a value (i.e. sin  $x$ , A, etc.)
- step value: numeric value (default: 1)



**Description:**

- The default step value is 1.
- Making the starting value less than the ending value and specifying a positive step value causes the control variable to be incremented with each execution. Making the starting value greater than the ending value and specifying a negative step value causes the control variable to be decremented with each execution.

**Do~LpWhile**

**Function:** This command repeats specific commands as long as its condition is true (non-zero).

**Syntax:**

Do { : } <statement> { : } LpWhile <condition>  
numeric expression

**Parameters:** expression

**Description:**

- This command repeats the commands contained in the loop as long as its condition is true (non-zero). When the condition becomes false (0), execution proceeds from the statement following the LpWhile-statement.
- Since the condition comes after the LpWhile-statement, the condition is tested (checked) after all of the commands inside the loop are executed.





## While~WhileEnd

**Function:** This command repeats specific commands as long as its condition is true (non-zero).

**Syntax:**

While    <condition>    { : } <statement> { : } WhileEnd  
          numeric expression

**Parameters:** expression

**Description:**

- This command repeats the commands contained in the loop as long as its condition is true (non-zero). When the condition becomes false (0), execution proceeds from the statement following the WhileEnd-statement.
- Since the condition comes after the While-statement, the condition is tested (checked) before the commands inside the loop are executed.

---

## ■ Program Control Commands (CTL)

### Break

**Function:** This command breaks execution of a loop and continues from the next command following the loop.

**Syntax:** Break

**Description:**

- This command breaks execution of a loop and continues from the next command following the loop.
- This command can be used to break execution of a For-statement, Do-statement, and While-statement.



## Prog

**Function:** This command specifies execution of another program as a subroutine. In the RUN•MAT Mode, this command executes a new program.

**Syntax:** Prog "file name"

**Example:** Prog "ABC"

**Description:**

- Even when this command is located inside of a loop, its execution immediately breaks the loop and launches the subroutine.
- This command can be used as many times as necessary inside of a main routine to call up independent subroutines to perform specific tasks.
- A subroutine can be used in multiple locations in the same main routine, or it can be called up by any number of main routines.

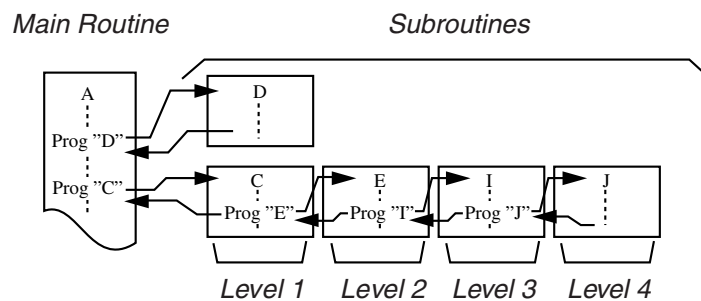

- Calling up a subroutine causes it to be executed from the beginning. After execution of the subroutine is complete, execution returns to the main routine, continuing from the statement following the Prog command.
- A Goto~Lbl command inside of a subroutine is valid inside of that subroutine only. It cannot be used to jump to a label outside of the subroutine.
- If a subroutine with the file name specified by the Prog command does not exist, an error occurs.
- In the **RUN•MAT Mode**, inputting the Prog command and pressing **EXE** launches the program specified by the command.

## Return

**Function:** This command returns from a subroutine.

**Syntax:** Return

**Description:**

Execution of the Return command inside a main routine causes execution of the program to stop. Execution of the Return command within a subroutine terminates the subroutine and returns to the program from which the subroutine was jumped to.

## Stop

**Function:** This command terminates execution of a program.

**Syntax:** Stop

**Description:**

- This command terminates program execution.
- Execution of this command inside of a loop terminates program execution without an error being generated.



## ■ Jump Commands (JUMP)

### Dsz

**Function:** This command is a count jump that decrements the value of a control variable by 1, and then jumps if the current value of the variable is zero.

**Syntax:**

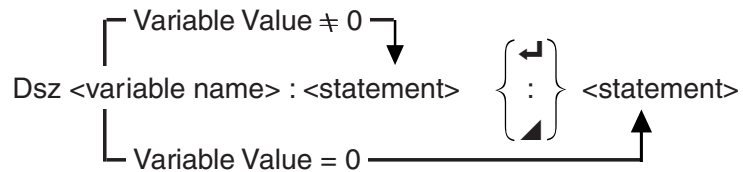

**Parameters:** variable name: A to Z, r,  $\theta$

[Example] Dsz B : Decrements the value assigned to variable B by 1.

**Description:**

This command decrements the value of a control variable by 1, and then tests (checks) it. If the current value is non-zero, execution continues with the next statement. If the current value is zero, execution jumps to the statement following the multi-statement command (:), display command (▲), or carriage return (↵).



## Goto~Lbl

**Function:** This command performs an unconditional jump to a specified location.

**Syntax:** Goto <label name> ~ Lbl <label name>

**Parameters:** label name: value (0 to 9), variable (A to Z, r,  $\theta$ )

**Description:**

- This command consists of two parts: Goto  $n$  (where  $n$  is a parameter as described above) and Lbl  $n$  (where  $n$  is the parameter referenced by Goto  $n$ ). This command causes program execution to jump to the Lbl-statement whose  $n$  parameter matches that specified by the Goto-statement.
- This command can be used to loop back to the beginning of a program or to jump to any location within the program.
- This command can be used in combination with conditional jumps and count jumps.
- If there is no Lbl-statement whose value matches that specified by the Goto-statement, an error occurs.



## Isz

**Function:** This command is a count jump that increments the value of a control variable by 1, and then jumps if the current value of the variable is zero.

**Syntax:**

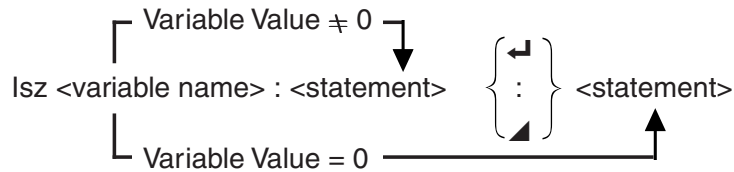

**Parameters:** variable name: A to Z,  $r$ ,  $\theta$

[Example] `Isz A` : Increments the value assigned to variable A by 1.

**Description:**

This command increments the value of a control variable by 1, and then tests (checks) it. If the current value is non-zero, execution continues with the next statement. If the current value is zero, execution jumps to the statement following the multi-statement command (:), display command ( $\blacktriangleleft$ ), or carriage return ( $\blacktriangleleft$ ).

## ■ Clear Commands (CLR)

### ClrGraph

**Function:** This command clears the graph screen and returns View Windows settings to their INIT values.

**Syntax:** `ClrGraph`

**Description:** This command clears the graph screen during program execution.

### ClrList

**Function:** This command deletes list data.

**Syntax:** `ClrList <list name>`

`ClrList`

**Parameters:** list name: 1 to 20, Ans

**Description:** This command deletes the data in the list specified by "list name". All list data is deleted if nothing is specified for "list name".



### ClrText

**Function:** This command clears the text screen.

**Syntax:** ClrText

**Description:** This command clears text from the screen during program execution.

### ClrMat

**Function:** This command deletes matrix data.

**Syntax:** ClrMat <matrix name>

ClrMat

**Parameters:** matrix name: A to Z, Ans

**Description:** This command deletes the data in the matrix specified by “matrix name”. All matrix data is deleted if nothing is specified for “matrix name”.

---

## ■ Display Commands (DISP)

### DispF-Tbl, DispR-Tbl

No parameters

**Function:** These commands display numeric tables.

**Description:**

- These commands generate numeric tables during program execution in accordance with conditions defined within the program.
- DispF-Tbl generates a function table, while DispR-Tbl generates a recursion table.

### DrawDyna

No parameters

**Function:** This command executes a Dynamic Graph draw operation.

**Description:** This command draws a Dynamic Graph during program execution in accordance with current Dynamic Graph parameters.



**DrawFTG-Con, DrawFTG-Plt**

No parameters

**Function:** This command uses values in a generated table to graph a function.

**Description:**

- This command draws a function graph in accordance with current conditions.
- DrawFTG-Con produces a connect type graph, while DrawFTG-Plt produces a plot type graph.

**DrawGraph**

No parameters

**Function:** This command draws a graph.

**Description:**

- This command draws a graph in accordance with current conditions.

**DrawR-Con, DrawR-Plt**

No parameters

**Function:** These commands use values in a generated table to graph a recursion expression with  $a_n(b_n \text{ or } c_n)$  as the vertical axis and  $n$  as the horizontal axis.

**Description:**

- These commands graph recursion expressions in accordance with current conditions, with  $a_n(b_n \text{ or } c_n)$  as the vertical axis and  $n$  as the horizontal axis.
- DrawR-Con produces a connect type graph, while DrawR-Plt produces a plot type graph.





### DrawR $\Sigma$ -Con, DrawR $\Sigma$ -Plt

No parameters

**Function:** These commands use values in a generated table to graph a recursion expression with  $\Sigma a_n(\Sigma b_n$  or  $\Sigma c_n)$  as the vertical axis and  $n$  as the horizontal axis.

**Description:**

- These commands graph recursion expressions in accordance with current conditions, with  $\Sigma a_n(\Sigma b_n$  or  $\Sigma c_n)$  as the vertical axis and  $n$  as the horizontal axis.
- DrawR $\Sigma$ -Con produces a connect type graph, while DrawR $\Sigma$ -Plt produces a plot type graph.

### DrawStat

**Function:** This draws a statistical graph.

**Syntax:** See “8-6-9 Using Statistical Calculations and Graphs in a Program”.

**Description:**

This command draws a statistical graph in accordance with current statistical graph conditions.

### DrawWeb

**Function:** This command graphs convergence/divergence of a recursion expression (WEB graph).

**Syntax:** DrawWeb <recursion type>, <number of lines>

**Example:** DrawWeb  $a_{n+1}$  ( $b_{n+1}$  or  $c_{n+1}$ ), 5

**Description:**

- This command graphs convergence/divergence of a recursion expression (WEB graph).
- Omitting the number of lines specification automatically specifies the default value 30.



## ■ Input/Output Commands (I/O)

### Getkey

**Function:** This command returns the code that corresponds to the last key pressed.

**Syntax:** Getkey

**Description:**

- This command returns the code that corresponds to the last key pressed.

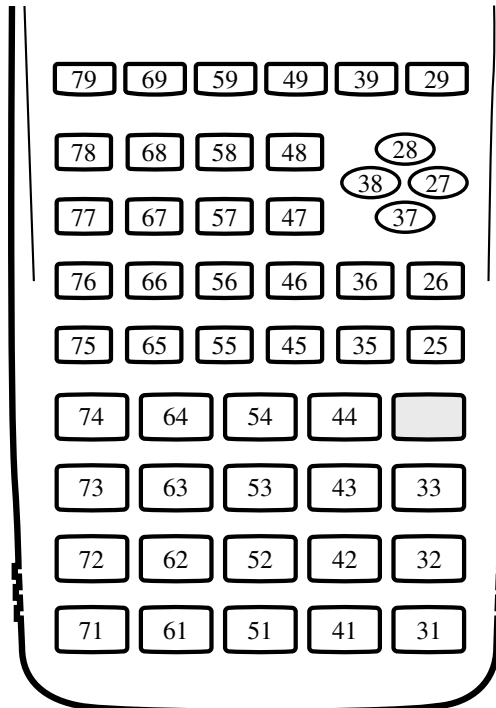

- A value of zero is returned if no key was pressed previous to executing this command.
- This command can be used inside of a loop.

## Locate

**Function:** This command displays alpha-numeric characters at a specific location on the text screen.

**Syntax:** Locate <column number>, <line number>, <value>

Locate <column number>, <line number>, <numeric expression>

Locate <column number>, <line number>, "<string>"

[Example] Locate 1, 1, "AB" ↵

### Parameters:

- line number: number from 1 to 7
- column number: number from 1 to 21
- value and numeric expression
- string: character string

### Description:

- This command displays values (including variable contents) or text at a specific location on the text screen. If there is a calculation input, that calculation result is displayed.
- The row is designated by a value from 1 to 7, which the column is designated by a value from 1 to 21.



**Example:** Cls ↵

Locate 7, 1, "CASIO FX"

This program displays the text "CASIO FX" in the center of the screen.

- In some cases, the ClrText command should be executed before running the above program.



## Receive ( / Send (

**Function:** This command receives data from and sends data to a connected device.

**Syntax:** Receive (<data>) / Send (<data>)

**Description:**

- This command receives data from and sends data to a connected device.
- The following types of data can be received (sent) by this command.
  - Individual values assigned to variables
  - Matrix data (all values - individual values cannot be specified)
  - List data (all values - individual values cannot be specified)



---

## ■ Conditional Jump Relational Operators (REL)

=, ≠, >, <, ≥, ≤

**Function:** These relational operators are used in combination with the conditional jump command.

**Syntax:**

<left side> <relational operator> <right side>

**Parameters:**

left side/right side: variable (A to Z,  $r$ ,  $\theta$ ), numeric constant, variable expression (such as:  $A \times 2$ )

relational operator: =, ≠, >, <, ≥, ≤





---

- To calculate a scalar product (**\*Row**)

• • • • •

**Example 2** To calculate the scalar product of Row 2 of the matrix in Example 1, multiplying by 4

The following is the syntax to use for this program.

\* Row 4, A, 2 ↵  
 ↳ Row  
 ↳ Matrix name  
 ↳ Multiplier  
 Mat A

Executing this program produces the following result.

| Ans | 1  | 2  |
|-----|----|----|
| 1   |    | 2  |
| 2   | 12 | 16 |
| 3   | 5  | 6  |

---

- To calculate a scalar product and add the results to another row (**\*Row+**)

• • • • •

**Example 3** To calculate the scalar product of Row 2 of the matrix in Example 1, multiplying by 4, and add the result to row 3

The following is the syntax to use for this program.

\* Row+ 4, A, 2, 3 ↵  
 ↳ Rows to be added  
 ↳ Row for which scalar product is to be calculated.  
 ↳ Matrix name  
 ↳ Multiplier  
 Mat A

Executing this program produces the following result.

| Ans | 1  | 2  |
|-----|----|----|
| 1   |    | 2  |
| 2   | 3  | 4  |
| 3   | 17 | 22 |







---

- **Syntax of other graphing functions**

- V-Window

View Window <Xmin>, <Xmax>, <Xscale>, <Ymin>, <Ymax>, <Yscale>, <T $\theta$ min>, <T $\theta$ max>, <T $\theta$ pitch>

StoV-Win <area of V-Win> ..... area: 1 to 6

RclV-Win <area of V-Win> ..... area: 1 to 6

- Zoom

Factor <X factor>, <Y factor>

ZoomAuto ..... Non-parameter

- Pict

StoPict <area of picture> ..... area: 1 to 20

RclPict <area of picture> ..... area: 1 to 20

- Sketch

PlotOn <X-coordinate>, <Y-coordinate>

PlotOff <X-coordinate>, <Y-coordinate>

PlotChg <X-coordinate>, <Y-coordinate>

PxlOn<line number>, <column number>

PxlOff<line number>, <column number>

PxlChg<line number>, <column number>

PxlTest( <line number>, <column number>[])

F-Line <X-coordinate 1>, <Y-coordinate 1>, <X-coordinate 2>, <Y-coordinate 2>

Text <line number>, <column number>, "<text>"

Text <line number>, <column number>, <expression>

Tangent <function>, <X-coordinate>

Normal <function>, <X-coordinate>

Inverse <function>

Circle <center point X-coordinate>, <center point Y-coordinate>, <radius R value>

Vertical <X-coordinate>

Horizontal <Y-coordinate>



## ■ Using Dynamic Graph Functions in a Program

Using Dynamic Graph functions in a program makes it possible to perform repeat Dynamic Graph operations. The following shows how to specify the Dynamic Graph range inside a program.

### • Dynamic Graph range

1 → D Start ↵

5 → D End ↵

1 → D pitch ↵

### Example Program

ClrGraph ↵

View Window -5, 5, 1, -5, 5, 1 ↵

Y = Type ↵

"AX + 1" → Y1 ↵

② D SelOn 1 ↵

③ D Var A ↵

1 → ④ D Start ↵

5 → ⑤ D End ↵

1 → ⑥ D pitch ↵

⑦ DrawDyna

① VARS F4 1 ESC

② F6 F2 1

③ F2 3

④ VARS F5 1

⑤ F5 2

⑥ F5 3

⑦ SHIFT VARS F6 F6 F2 3

Executing this program produces the result shown here.

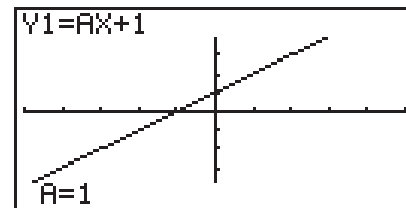

⋮ ↑  
↓ ⋮



## ■ Using Table & Graph Functions in a Program

Table & Graph functions in a program can generate numeric tables and perform graphing operations. The following shows various types of syntax you need to use when programming with Table & Graph functions.

- Table range setting

1 → F Start ↵

5 → F End ↵

1 → F pitch ↵

- Numeric table generation

DispF-Tbl ↵

- Graph draw operation

Connect type: DrawFTG-Con ↵

Plot type: DrawFTG-Plt ↵

### Example Program

ClrGraph ↵

ClrText ↵

View Window 0, 6, 1, -20, 106, 10 ↵

Y = Type ↵

"3X<sup>2</sup> - 2" → Y1 ↵

① G SelOn 1 ↵

0 → ② F Start ↵

6 → ③ F End ↵

1 → ④ F pitch ↵

⑤ DispF-Tbl ↵

⑥ DrawFTG-Con

① F6 F1 1

② VARS F6 F1 1

③ F1 2

④ F1 3

⑤ SHIFT VARS F6 F6 F2 4 1

⑥ SHIFT VARS F6 F6 F2 4 2

Executing this program produces the results shown here.

Numeric Table

| X | Y1 |
|---|----|
| 0 | -2 |
| 1 | 1  |
| 2 | 10 |
| 3 | 25 |

Graph

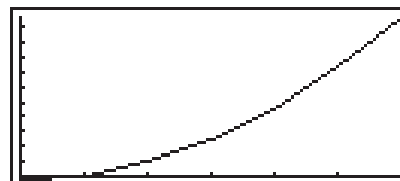

## ■ Using Recursion Table & Graph Functions in a Program

Incorporating Recursion Table & Graph functions in a program lets you generate numeric tables and perform graphing operations. The following shows various types of syntax you need to use when programming with Recursion Table & Graph functions.

- Recursion formula input

$a_{n+1}$  Type  $\leftarrow$  ..... Specifies recursion type.

" $3a_n + 2$ "  $\rightarrow a_{n+1}$   $\leftarrow$

" $4b_n + 6$ "  $\rightarrow b_{n+1}$   $\leftarrow$

- Table range setting

1  $\rightarrow$  R Start  $\leftarrow$

5  $\rightarrow$  R End  $\leftarrow$

1  $\rightarrow a_0$   $\leftarrow$

2  $\rightarrow b_0$   $\leftarrow$

1  $\rightarrow a_n$  Start  $\leftarrow$

3  $\rightarrow b_n$  Start  $\leftarrow$

- Numeric table generation

DispR-Tbl  $\leftarrow$

- Graph draw operation

Connect type: DrawR-Con  $\leftarrow$ , DrawR $\Sigma$ -Con  $\leftarrow$

Plot type: DrawR-Plt  $\leftarrow$ , DrawR $\Sigma$ -Plt  $\leftarrow$

- Statistical convergence/divergence graph (WEB graph)

DrawWeb  $a_{n+1}$ , 10  $\leftarrow$



**Example Program**

View Window 0, 1, 1, -0.2, 1, 1 ↵

①  $a_{n+1}$  Type ↵② " $-3a_n^2 + 3a_n$ " →  $a_{n+1}$  ↵

④ 0 → R Start ↵

⑤ 6 → R End ↵

⑥ 0.01 →  $a_0$  ↵⑦ 0.01 →  $a_n$  Start ↵

⑧ DispR-Tbl ▲

⑨ DrawWeb  $a_{n+1}$ , 30

① F6 F3 6 2

② F3 1 2

③ F3 1 3

④ VARS F6 F2 2 1

⑤ F2 2 2

⑥ F2 2 3

⑦ F2 2 C

⑧ SHIFT VARS F6 F6 F2 5 1

⑨ F2 5 2 ESC

⑩ F6 F3 1 3

Executing this program produces the results shown here.

Numeric Table

| n+1 | $a_{n+1}$ |
|-----|-----------|
| 0   | 0.01      |
| 1   | 0.0297    |
| 2   | 0.0864    |
| 3   | 0.2369    |

Recursion graph

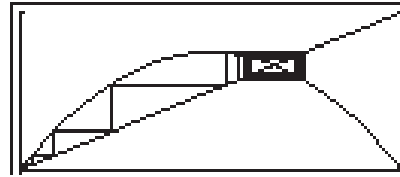
**Using List Sort Functions in a Program**

These functions let you sort the data in lists into ascending or descending order.

## • Ascending order

① SortA (List 1, List 2, List 3)

Lists to be sorted (up to six can be specified)

① F5 1    ② F4 4

## • Descending order

③ SortD (List 1, List 2, List 3)

Lists to be sorted (up to six can be specified)

③ F5 2



## ■ Using Solve Calculation Function in a Program

The following is the syntax for using the Solve function in a program.

Solve(  $f(x)$ ,  $n$ ,  $a$ ,  $b$  )

Upper limit  
 Lower limit  
 Initial estimated value

### Example Program

①Solve(  $2X^2 + 7X - 9$ , 1, 0, 1)                      ① **OPTN** **F4** **7**

- In the function  $f(x)$ , only X can be used as a variable in expressions. Other variables (A through Z,  $r$ ,  $\theta$ ) are treated as constants, and the value currently assigned to that variable is applied during the calculation.
- Input of the closing parenthesis, lower limit  $a$  and upper limit  $b$  can be omitted.

## ■ Using Statistical Calculations and Graphs in a Program

Including statistical calculations and graphing operations in program lets you calculate and graph statistical data.

### • To set conditions and draw a statistical graph

Following “StatGraph”, you must specify the following graph conditions:

- Graph draw/non-draw status (DrawOn/DrawOff)
- Graph Type
- $x$ -axis data location (list name)
- $y$ -axis data location (list name)
- Frequency data location (list name)
- Mark Type



# Solutions obtained using Solve may include errors.

# You cannot use a differential, quadratic differential, integration,  $\Sigma$ , maximum/minimum value or Solve calculation expression inside of a Solve calculation term.



The graph conditions that are required depends on the graph type. See “Changing Graph Parameters” (page 6-1-2).

- The following is a typical graph condition specification for a scatter diagram or *xy*Line graph.

S-Gph1 DrawOn, Scatter, List 1, List 2, 1, Square ↵

In the case of an *xy* line graph, replace “Scatter” in the above specification with “*xy*Line”.

- The following is a typical graph condition specification for a normal probability plot.

S-Gph1 DrawOn, NPPlot, List 1, Square ↵

- The following is a typical graph condition specification for a single-variable graph.

S-Gph1 DrawOn, Hist, List 1, List 2 ↵

The same format can be used for the following types of graphs, by simply replacing “Hist” in the above specification with the applicable graph type.

Histogram: ..... Hist

Median Box: ..... MedBox

Modified Box: ..... Modified

Normal Distribution: ..... N-Dist

Broken Line: ..... Broken

- The following is a typical graph condition specification for a regression graph.

S-Gph1 DrawOn, Linear, List 1, List 2, List 3 ↵

The same format can be used for the following types of graphs, by simply replacing “Linear” in the above specification with the applicable graph type.

Linear Regression: ..... Linear

Med-Med: ..... Med-Med

Quadratic Regression: ..... Quad

Cubic Regression: ..... Cubic

Quartic Regression: ..... Quart

Logarithmic Regression: ..... Log

Exponential Regression: ..... Exp

Power Regression: ..... Power



- The following is a typical graph condition specification for a sinusoidal regression graph.  
S-Gph1 DrawOn, Sinusoidal, List 1, List 2 ↵
- The following is a typical graph condition specification for a logistic regression graph.  
S-Gph1 DrawOn, Logistic, List 1, List 2 ↵

### Example Program

ClrGraph ↵

① S-Wind Auto ↵

{1, 2, 3} → List 1 ↵

{1, 2, 3} → List 2 ↵

② S-Gph1 DrawOn, ③ Scatter, ④ List 1, List 2, ⑤ 1, Square ↵

⑥ DrawStat

① CTRL F3 F5 1 1 ESC

② F4 1 1

③ F4 2 1

④ F4 3 1

⑤ F4 5 1

⑥ SHIFT VARS F6 F6 F2 1

Executing this program produces the scatter diagram shown here.

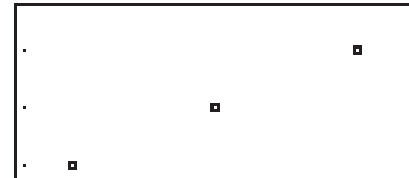

## ■ Performing Statistical Calculations

- Single-variable statistical calculation

① 1-Variable List 1, List 2

Frequency data (Frequency)

*x*-axis data (XList)

① F4 6 1

```

1-Variable
x̄ = 2.33333333
Σx = 14
Σx² = 36
x̄n = 0.74535599
x̄n-1 = 0.81649658
n = 6
↓

```



- Paired-variable statistical calculation

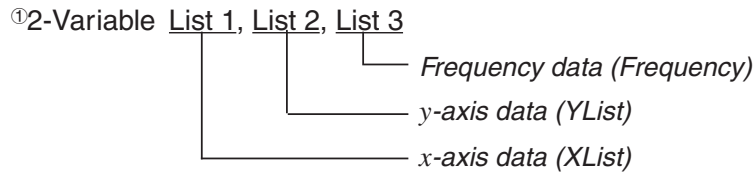

① **F4** **6** **2**

```
2-Variable
Σx =2
Σy =6
Σxy =14
x̄n =0.81649658
ȳn =1
n =3
```

- Regression statistical calculation

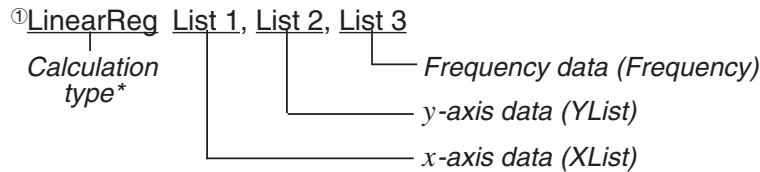

① **F4** **6** **3**

```
LinearRes
a =1
b =0
r =1
r² =1
y=ax+b
```

\* Any one of the following can be specified as the calculation type.

- LinearReg ..... linear regression
- Med-MedLine .... Med-Med calculation
- QuadReg ..... quadratic regression
- CubicReg ..... cubic regression
- QuartReg ..... quartic regression
- LogReg ..... logarithmic regression
- ExpReg ..... exponential regression
- PowerReg ..... power regression

- Sinusoidal regression statistical calculation

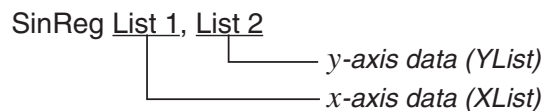

- Logistic regression statistical calculation

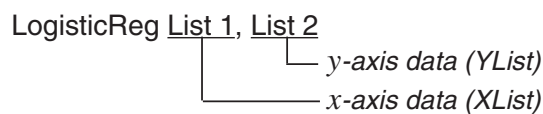

# 8-7 Program Mode Command List

## RUN Program

| Level 1 | Level 2                  | Level 3      | Command     |
|---------|--------------------------|--------------|-------------|
| MAT     | Swap                     |              | Swap_       |
|         | *Row                     |              | *Row_       |
|         | *Row+                    |              | *Row+_      |
|         | Row+                     |              | Row+_       |
| STAT    | S-GPH                    | S-Gph1       | S-Gph1_     |
|         |                          | S-Gph2       | S-Gph2_     |
|         |                          | S-Gph3       | S-Gph3_     |
|         | DRAW                     | On           | DrawOn      |
|         |                          | Off          | DrawOff     |
|         | GRAPH                    | Scat         | Scatter     |
|         |                          | xyLine       | xyLine      |
|         |                          | NPPlot       | NPPlot      |
|         |                          | Hist         | Hist        |
|         |                          | Box          | MedBox      |
|         |                          | ModBox       | ModifiedBox |
|         |                          | N-Dist       | N-Dist      |
|         |                          | Broken       | Broken      |
|         |                          | Linear       | Linear      |
|         |                          | MedMed       | Med-Med     |
|         |                          | Quad         | Quad        |
|         |                          | Cubic        | Cubic       |
|         |                          | Quart        | Quart       |
|         | Log                      | Log          |             |
|         | Exp                      | Exp          |             |
| Power   | Power                    |              |             |
| Sin     | Sinusoidal               |              |             |
| Lgstic  | Logistic                 |              |             |
| List    |                          | List_        |             |
| MARK    | <input type="checkbox"/> | Square       |             |
|         | ×                        | Cross        |             |
|         | •                        | Dot          |             |
| CALC    | 1VAR                     | 1-Variable_  |             |
|         | 2VAR                     | 2-Variable_  |             |
|         | Linear                   | LinearReg_   |             |
|         | MedMed                   | Med-MedLine_ |             |
|         | Quad                     | QuadReg_     |             |
|         | Cubic                    | CubicReg_    |             |
|         | Quart                    | QuartReg_    |             |
|         | Log                      | LogReg_      |             |
|         | Exp                      | ExpReg_      |             |
|         | Power                    | PowerReg_    |             |
| Sin     | SinReg_                  |              |             |
| Lgstic  | LogisticReg_             |              |             |
| LIST    | SortA                    | SortA(       |             |
|         | SortD                    | SortD(       |             |

| GRPH   | SelOn  |           | G_SelOn_  |         |
|--------|--------|-----------|-----------|---------|
|        | SelOff |           | G_SelOff_ |         |
| TYPE   | Y=     |           | Y=TYPE    |         |
|        | r=     |           | r=TYPE    |         |
|        | Param  |           | ParamTYPE |         |
|        | X=c    |           | X=cTYPE   |         |
|        | Y>     |           | Y>Type    |         |
|        | Y<     |           | Y<Type    |         |
|        | Y≥     |           | Y≥Type    |         |
|        | Y≤     |           | Y≤Type    |         |
|        | GMEM   | Store     |           | StoGMEM |
|        | Recall |           |           | RclGMEM |
| DYNA   | SelOn  |           | D_SelOn_  |         |
|        | SelOff |           | D_SelOff_ |         |
|        | Var    |           | D_Var_    |         |
|        | TYPE   | Y=        |           | Y=Type  |
|        |        | r=        |           | r=Type  |
|        | Param  |           | ParamType |         |
|        | RECR   | n,an..    | n         | n       |
|        |        |           | an        | an      |
|        |        |           | an+1      | an+1    |
|        |        |           | bn        | bn      |
|        |        | bn+1      | bn+1      |         |
|        |        | cn        | cn        |         |
|        |        | cn+1      | cn+1      |         |
| SelOn  |        |           | R_SelOn_  |         |
| SelOff |        | R_SelOff_ |           |         |
| Sel a0 |        | Sel_a0    |           |         |
| Sel a1 |        | Sel_a1    |           |         |
| TYPE   | an     |           | anType    |         |
|        | an+1   |           | an+1Type  |         |
|        | an+2   |           | an+2Type  |         |

| [OPTN] key        |         |                                 |                   |                                   |
|-------------------|---------|---------------------------------|-------------------|-----------------------------------|
| Level 1           | Level 2 | Level 3                         | Command           |                                   |
| LIST              | List    |                                 | List_             |                                   |
|                   | Dim     |                                 | Dim_              |                                   |
|                   | Seq     |                                 | Seq(              |                                   |
|                   | Min     |                                 | Min(              |                                   |
|                   | Max     |                                 | Max(              |                                   |
|                   | Mean    |                                 | Mean(             |                                   |
|                   | Median  |                                 | Median(           |                                   |
|                   | Sum     |                                 | Sum_              |                                   |
|                   | Prod    |                                 | Prod_             |                                   |
|                   | Cuml    |                                 | Cuml_             |                                   |
|                   | %       |                                 | Percent_          |                                   |
|                   | ΔList   |                                 | ΔList_            |                                   |
|                   | Augmnt  |                                 | Augment(          |                                   |
|                   | Fill    |                                 | Fill(             |                                   |
| L→Mat             |         | List→Mat(                       |                   |                                   |
| MAT               | Mat     |                                 | Mat_              |                                   |
|                   | Dim     |                                 | Dim_              |                                   |
|                   | Det     |                                 | Det_              |                                   |
|                   | Trn     |                                 | Trn_              |                                   |
|                   | Augmnt  |                                 | Augment(          |                                   |
|                   | Ident   |                                 | Identity_         |                                   |
|                   | Fill    |                                 | Fill(             |                                   |
|                   | M→List  |                                 | Mat→List(         |                                   |
|                   | CPLX    | Abs                             |                   | Abs_                              |
|                   |         | Arg                             |                   | Arg_                              |
| Conjg             |         |                                 | Conjg_            |                                   |
| ReP               |         |                                 | ReP_              |                                   |
| ImP               |         |                                 | ImP_              |                                   |
| ►re <sup>θi</sup> |         |                                 | ►re <sup>θi</sup> |                                   |
| ►a+bi             |         |                                 | ►a+bi             |                                   |
| CALC              |         | d/dx                            |                   | d/dx(                             |
|                   |         | d <sup>2</sup> /dx <sup>2</sup> |                   | d <sup>2</sup> /dx <sup>2</sup> ( |
|                   |         | ∫dx                             |                   | ∫(                                |
|                   | Σ       |                                 | Σ(                |                                   |
|                   | FMin    |                                 | FMin(             |                                   |
|                   | FMax    |                                 | FMax(             |                                   |
|                   | Solve   |                                 | Solve(            |                                   |
|                   | NUM     | Abs                             |                   | Abs_                              |
|                   |         | Int                             |                   | Int_                              |
|                   |         | Frac                            |                   | Frac_                             |
| Rnd               |         |                                 | Rnd               |                                   |
| Intg              |         |                                 | Intg_             |                                   |
| E-SYM             |         | m                               |                   | m                                 |
|                   |         | μ                               |                   | μ                                 |
|                   |         | n                               |                   | n                                 |
|                   |         | p                               |                   | p                                 |
|                   |         | f                               |                   | f                                 |
|                   | k       |                                 | k                 |                                   |
|                   | M       |                                 | M                 |                                   |
|                   | G       |                                 | G                 |                                   |
|                   | T       |                                 | T                 |                                   |
|                   | P       |                                 | P                 |                                   |
| E                 |         | E                               |                   |                                   |

|                    |        |             |                      |          |
|--------------------|--------|-------------|----------------------|----------|
| PROB               | x!     |             | !                    |          |
|                    | nPr    |             | P                    |          |
|                    | nCr    |             | C                    |          |
|                    | Ran#   |             | Ran#_                |          |
|                    | P(     |             | P(                   |          |
|                    | Q(     |             | Q(                   |          |
|                    | R(     |             | R(                   |          |
|                    | t(     |             | t(                   |          |
|                    | HYP    | sinh        |                      | sinh_    |
|                    |        | cosh        |                      | cosh_    |
| tanh               |        |             | tanh_                |          |
| sinh <sup>-1</sup> |        |             | sinh <sup>-1</sup> _ |          |
| cosh <sup>-1</sup> |        |             | cosh <sup>-1</sup> _ |          |
| tanh <sup>-1</sup> |        |             | tanh <sup>-1</sup> _ |          |
| ANGL               | °      |             | °                    |          |
|                    | r      |             | r                    |          |
|                    | g      |             | g                    |          |
|                    | ◦ ° "  |             | ◦ ° "                |          |
|                    | ►DMS   |             | ►DMS                 |          |
|                    | Pol(   |             | Pol(                 |          |
| Rec(               |        | Rec(        |                      |          |
| STAT               | χ      |             | χ                    |          |
|                    | ψ      |             | ψ                    |          |
| FMEM               | fn     |             | fn                   |          |
| ZOOM               | Factor |             | Factor_              |          |
|                    | Auto   |             | ZoomAuto             |          |
| SKTCH              | Cis    |             | Cis                  |          |
|                    |        | PLOT        | On                   | PlotOn   |
|                    |        |             | Off                  | PlotOff  |
|                    |        |             | Change               | PlotChg_ |
|                    | Plot   |             | Plot_                |          |
|                    | LINE   | F-Line      |                      | F-Line_  |
|                    |        | Line        |                      | Line     |
|                    | GRAPH  | Y=          |                      | Graph_Y= |
|                    |        | ∫dx         |                      | Graph_∫  |
|                    | Text   |             | Text                 |          |
| PIXEL              | On     |             | PxlOn_               |          |
|                    |        |             | PxlOff               |          |
|                    | Off    |             | PxlChg_              |          |
|                    |        | Change      |                      | PxlTest( |
|                    | Test   |             |                      |          |
|                    | Tangnt |             | Tangent_             |          |
| Normal             |        | Normal_     |                      |          |
| Invrse             |        | Inverse_    |                      |          |
| Circle             |        | Circle_     |                      |          |
| Vert               |        | Vertical_   |                      |          |
| Horz               |        | Horizontal_ |                      |          |
| PICT               | Store  |             | StoPict_             |          |
|                    | Recall |             | RclPict_             |          |
| SYBL               | ,      |             | ,                    |          |
|                    | "      |             | "                    |          |
|                    | ~      |             | ~                    |          |
|                    | *      |             | *                    |          |
|                    | #      |             | #                    |          |
|                    | ◦ ° "  |             | ◦ ° "                |          |



8-7-2  
Program Mode Command List

| [VARS] key |                |                |                      |          |
|------------|----------------|----------------|----------------------|----------|
| Level 1    | Level 2        | Level 3        | Command              |          |
| V-WIN      | Xmin           |                | <b>Xmin</b>          |          |
|            | Xmax           |                | <b>Xmax</b>          |          |
|            | Xscale         |                | <b>Xscl</b>          |          |
|            | Xdot           |                | <b>Xdot</b>          |          |
|            | Ymin           |                | <b>Ymin</b>          |          |
|            | Ymax           |                | <b>Ymax</b>          |          |
|            | Yscale         |                | <b>Yscl</b>          |          |
|            | Tθmin          |                | <b>Tθmin</b>         |          |
|            | Tθmax          |                | <b>Tθmax</b>         |          |
|            | Tθptch         |                | <b>Tθptch</b>        |          |
|            | R-Xmin         |                | <b>RightXmin</b>     |          |
|            | R-Xmax         |                | <b>RightXmax</b>     |          |
|            | R-Xscl         |                | <b>RightXscl</b>     |          |
|            | R-Xdot         |                | <b>RightXdot</b>     |          |
|            | R-Ymin         |                | <b>RightYmin</b>     |          |
|            | R-Ymax         |                | <b>RightYmax</b>     |          |
|            | R-Yscl         |                | <b>RightYscl</b>     |          |
|            | R-Tmin         |                | <b>RightTθmin</b>    |          |
|            | R-Tmax         |                | <b>RightTθmax</b>    |          |
|            | R-Tpch         |                | <b>RightTθptch</b>   |          |
| FACT       | Xfact          |                | <b>Xfct</b>          |          |
|            | Yfact          |                | <b>Yfct</b>          |          |
| STAT       | n              |                | <b>n</b>             |          |
|            | X              | $\bar{x}$      | $\bar{x}$            |          |
|            |                | $\Sigma x$     | $\Sigma x$           |          |
|            |                | $\Sigma x^2$   | $\Sigma x^2$         |          |
|            |                | $x\sigma n$    | $x\sigma n$          |          |
|            |                | $x\sigma n-1$  | $x\sigma n-1$        |          |
|            |                | $\min X$       | $\min X$             |          |
|            | $\max X$       | $\max X$       |                      |          |
|            | Y              | $\bar{y}$      | $\bar{y}$            |          |
|            |                | $\Sigma y$     | $\Sigma y$           |          |
|            |                | $\Sigma y^2$   | $\Sigma y^2$         |          |
|            |                | $\Sigma xy$    | $\Sigma xy$          |          |
|            |                | $y\sigma n$    | $y\sigma n$          |          |
|            |                | $y\sigma n-1$  | $y\sigma n-1$        |          |
|            |                | $\min Y$       | $\min Y$             |          |
|            |                | $\max Y$       | $\max Y$             |          |
|            |                | GRAPH          | a                    | <b>a</b> |
|            |                |                | b                    | <b>b</b> |
|            |                |                | c                    | <b>c</b> |
|            |                |                | d                    | <b>d</b> |
|            | e              |                | <b>e</b>             |          |
|            | r              |                | <b>r</b>             |          |
|            | r <sup>2</sup> |                | <b>r<sup>2</sup></b> |          |
|            | Q1             |                | <b>Q1</b>            |          |
| Med        | <b>Med</b>     |                |                      |          |
| Q3         | <b>Q3</b>      |                |                      |          |
| Mod        | <b>Mod</b>     |                |                      |          |
| H-Strt     |                | <b>H_Start</b> |                      |          |
| H-ptch     |                | <b>H_pitch</b> |                      |          |

|        |                 |                   |                |           |
|--------|-----------------|-------------------|----------------|-----------|
| PTS    | x1              | x1                | <b>x1</b>      |           |
|        |                 | y1                | <b>y1</b>      |           |
|        |                 | x2                | <b>x2</b>      |           |
|        |                 | y2                | <b>y2</b>      |           |
|        |                 | x3                | <b>x3</b>      |           |
|        | y3              | y3                | <b>y3</b>      |           |
|        |                 | GRPH              | Yn             | <b>Y</b>  |
|        |                 |                   | rn             | <b>r</b>  |
|        |                 |                   | Xtn            | <b>Xt</b> |
|        |                 |                   | Ytn            | <b>Yt</b> |
| Xn     | <b>X</b>        |                   |                |           |
| DYNA   | Start           | <b>D_Start</b>    |                |           |
|        | End             | <b>D_End</b>      |                |           |
|        | Pitch           | <b>D_pitch</b>    |                |           |
| TABL   | Start           | <b>F_Start</b>    |                |           |
|        | End             | <b>F_End</b>      |                |           |
|        | Pitch           | <b>F_pitch</b>    |                |           |
|        | Result          | <b>F_Result</b>   |                |           |
| RECR   | FORM            | an                | <b>an</b>      |           |
|        |                 | an+1              | <b>an+1</b>    |           |
|        |                 | an+2              | <b>an+2</b>    |           |
|        |                 | bn                | <b>bn</b>      |           |
|        |                 | bn+1              | <b>bn+1</b>    |           |
|        |                 | bn+2              | <b>bn+2</b>    |           |
|        |                 | cn                | <b>cn</b>      |           |
|        |                 | cn+1              | <b>cn+1</b>    |           |
|        | RANGE           | R-Strt            | <b>R_Start</b> |           |
|        |                 | R-End             | <b>R_End</b>   |           |
|        |                 | a0                | <b>a0</b>      |           |
|        |                 | a1                | <b>a1</b>      |           |
|        |                 | a2                | <b>a2</b>      |           |
|        |                 | b0                | <b>b0</b>      |           |
|        |                 | b1                | <b>b1</b>      |           |
|        |                 | b2                | <b>b2</b>      |           |
| c0     | <b>c0</b>       |                   |                |           |
| c1     | <b>c1</b>       |                   |                |           |
| c2     | <b>c2</b>       |                   |                |           |
| anStrt | <b>anStart</b>  |                   |                |           |
| bnstrt | <b>bnStart</b>  |                   |                |           |
| cnStrt | <b>cnStart</b>  |                   |                |           |
| Result | <b>R_Result</b> |                   |                |           |
| EQUA   | S-Rslt          | <b>Sim_Result</b> |                |           |
|        | S-Coef          | <b>Sim_Coef</b>   |                |           |
|        | P-Rslt          | <b>Ply_Result</b> |                |           |
|        | P-Coef          | <b>Ply_Coef</b>   |                |           |

| [SHIFT][VARS](PRGM) key |         |             |                    |                    |
|-------------------------|---------|-------------|--------------------|--------------------|
| Level 1                 | Level 2 | Level 3     | Command            |                    |
| Prog                    |         |             | <b>Prog_</b>       |                    |
| JUMP                    | Lbl     |             | <b>Lbl_</b>        |                    |
|                         | Goto    |             | <b>Goto_</b>       |                    |
|                         | Isz     |             | <b>Isz_</b>        |                    |
|                         | Dsz     |             | <b>Dsz_</b>        |                    |
| ?                       |         |             | <b>?</b>           |                    |
| I/O                     | Locate  |             | <b>Locate_</b>     |                    |
|                         | Getkey  |             | <b>Getkey</b>      |                    |
|                         | Send    |             | <b>Send(</b>       |                    |
|                         | Receiv  |             | <b>Receive(</b>    |                    |
| IF                      | If      |             | <b>If_</b>         |                    |
|                         | Then    |             | <b>Then_</b>       |                    |
|                         | Else    |             | <b>Else_</b>       |                    |
|                         | IfEnd   |             | <b>IfEnd</b>       |                    |
| FOR                     | For     |             | <b>For_</b>        |                    |
|                         | To      |             | <b>_To_</b>        |                    |
|                         | Step    |             | <b>_Step_</b>      |                    |
|                         | Next    |             | <b>Next</b>        |                    |
| WHILE                   | While   |             | <b>While_</b>      |                    |
|                         | WhlEnd  |             | <b>WhileEnd</b>    |                    |
|                         | Do      |             | <b>Do</b>          |                    |
|                         | LpWhile |             | <b>LpWhile_</b>    |                    |
| CTRL                    | Prog    |             | <b>Prog_</b>       |                    |
|                         | Return  |             | <b>Return</b>      |                    |
|                         | Break   |             | <b>Break</b>       |                    |
|                         | Stop    |             | <b>Stop</b>        |                    |
| LOGIC                   | =       | <b>=</b>    | <b>=</b>           |                    |
|                         | ≠       | <b>≠</b>    | <b>≠</b>           |                    |
|                         | >       | <b>&gt;</b> | <b>&gt;</b>        |                    |
|                         | <       | <b>&lt;</b> | <b>&lt;</b>        |                    |
|                         | ≧       | <b>≧</b>    | <b>≧</b>           |                    |
|                         | ≦       | <b>≦</b>    | <b>≦</b>           |                    |
|                         | And     |             | <b>_And_</b>       |                    |
|                         | Or      |             | <b>_Or_</b>        |                    |
|                         | Not     |             | <b>Not_</b>        |                    |
|                         | CLR     | Text        |                    | <b>ClrText</b>     |
| Graph                   |         |             | <b>ClrGraph</b>    |                    |
| List                    |         |             | <b>ClrList</b>     |                    |
| Matrix                  |         |             | <b>ClrMat_</b>     |                    |
| DISP                    | Stat    |             | <b>DrawStat</b>    |                    |
|                         | Graph   |             | <b>DrawGraph</b>   |                    |
|                         | Dyna    |             | <b>DrawDyna</b>    |                    |
|                         | F-TBL   | Table       |                    | <b>DispF-Tbl</b>   |
|                         |         | G-Con       |                    | <b>DrawFTG-Con</b> |
|                         | G-Plot  |             | <b>DrawFTG-Pit</b> |                    |
|                         | R-TBL   | Table       |                    | <b>DispR-Tbl</b>   |
|                         |         | Web         |                    | <b>DrawWeb_</b>    |
|                         |         | R-Con       |                    | <b>DrawR-Con</b>   |
|                         |         | RΣ-Con      |                    | <b>DrawRΣ-Con</b>  |
| R-Plot                  |         |             | <b>DrawR-Pit</b>   |                    |
| RΣ-Pit                  |         |             | <b>DrawRΣ-Pit</b>  |                    |

| [CTRL][F3](SET UP) key |         |                   |                   |
|------------------------|---------|-------------------|-------------------|
| Level 1                | Level 2 | Level 3           | Command           |
| ANGL                   | Deg     |                   | <b>Deg</b>        |
|                        | Rad     |                   | <b>Rad</b>        |
|                        | Gra     |                   | <b>Gra</b>        |
| DISP                   | Fix     |                   | <b>Fix_</b>       |
|                        | Sci     |                   | <b>Sci_</b>       |
|                        | Norm    |                   | <b>Norm</b>       |
|                        | EngOn   |                   | <b>EngOn</b>      |
|                        | EngOff  |                   | <b>EngOff</b>     |
| CPLX                   | Real    |                   | <b>Real</b>       |
|                        | a+bi    |                   | <b>a+bi</b>       |
| GRPH                   | G-FUNC  | On                | <b>FuncOn</b>     |
|                        |         | Off               | <b>FuncOff</b>    |
|                        | D-TYPE  | G-Con             | <b>G-Connect</b>  |
|                        |         | G-Plot            | <b>G-Plot</b>     |
|                        | BG      | None              | <b>BG-None</b>    |
|                        |         | Pict              | <b>BG-Pict_</b>   |
| SIMUL                  | On      | <b>SimulOn</b>    |                   |
|                        | Off     | <b>SimulOff</b>   |                   |
| COORD                  | On      | <b>CoordOn</b>    |                   |
|                        | Off     | <b>CoordOff</b>   |                   |
| GRID                   | On      | <b>GridOn</b>     |                   |
|                        | Off     | <b>GridOff</b>    |                   |
| AXES                   | On      | <b>AxesOn</b>     |                   |
|                        | Off     | <b>AxesOff</b>    |                   |
| LABEL                  | On      | <b>LabelOn</b>    |                   |
|                        | Off     | <b>LabelOff</b>   |                   |
| STAT                   | S-WIN   | Auto              | <b>S-WindAuto</b> |
|                        |         | Manual            | <b>S-WindMan</b>  |
|                        | RESID   | None              | <b>Resid-None</b> |
| List                   |         | <b>Resid-List</b> |                   |
| DERIV                  | On      | <b>DerivOn</b>    |                   |
|                        | Off     | <b>DerivOff</b>   |                   |
| T-VAR                  | Range   | <b>VarRange</b>   |                   |
|                        | List    | <b>VarList_</b>   |                   |
| Σ•DSP                  | On      | <b>ΣdispOn</b>    |                   |
|                        | Off     | <b>ΣdispOff</b>   |                   |



## Program Mode Command List

## BASE Program

| [SHIFT][OPTN](V-Window)key |         |         |             |
|----------------------------|---------|---------|-------------|
| Level 1                    | Level 2 | Level 3 | Command     |
| V-Win                      |         |         | ViewWindow_ |
| Sto                        |         |         | StoV-Win_   |
| Rcl                        |         |         | RclV-Win_   |

| Level 1 | Level 2 | Level 3 | Command |
|---------|---------|---------|---------|
| d~o     | d       |         | d       |
|         | h       |         | h       |
|         | b       |         | b       |
|         | o       |         | o       |
| LOG     | Neg     |         | Neg_    |
|         | Not     |         | Not_    |
|         | and     |         | and     |
|         | or      |         | or      |
|         | xor     |         | xor     |
|         | xnor    |         | xnor    |
| DISP    | ►Dec    |         | ►Dec    |
|         | ►Hex    |         | ►Hex    |
|         | ►Bin    |         | ►Bin    |
|         | ►Oct    |         | ►Oct    |

| [CTRL][F3](SETUP) key |         |         |         |
|-----------------------|---------|---------|---------|
| Level 1               | Level 2 | Level 3 | Command |
| Dec                   |         |         | Dec     |
| Hex                   |         |         | Hex     |
| Bin                   |         |         | Bin     |
| Oct                   |         |         | Oct     |

| [SHIFT][VARIS](PRGM) key |         |         |         |
|--------------------------|---------|---------|---------|
| Level 1                  | Level 2 | Level 3 | Command |
| Prog                     |         |         | Prog_   |
| JUMP                     | Lbl     |         | Lbl_    |
|                          | Goto    |         | Goto_   |
|                          | Isz     |         | Isz_    |
|                          | Dsz     |         | Dsz_    |
| ?                        |         |         | ?       |
| ▲                        |         |         | ▲       |
| = ≠ <                    | =       |         | =       |
|                          | ≠       |         | ≠       |
|                          | >       |         | >       |
|                          | <       |         | <       |
|                          | ≡       |         | ≡       |
|                          | ≠       |         | ≠       |
| :                        |         |         | :       |



## 8-8 Program Library

- Be sure to check how many bytes of unused memory is remaining before attempting to perform any programming.

### Program Name

### Prime Factorization

#### Description

This program continually divides a natural number by factors until all its prime factors are produced.

#### Purpose

This program accepts input of natural number A, and divides it by B (2, 3, 5, 7....) to find the prime factors of A.

- If a division operation does not produce a remainder, the result of the operation is assigned to A.
- The above procedure is repeated until  $B > A$ .



#### Example

$$440730 = 2 \times 3 \times 3 \times 5 \times 59 \times 83$$

```
ClrText↵
"INPUT NUMBER"?→A↵
2→B↵
Do↵
While Frac (A/B)≠0↵
B↵
A/B→A↵
WhileEnd↵
If B=2↵
Then 3→B↵
Else B+2→B↵
IfEnd↵
LpWhile B≤A↵
"END"
```



8-8-2  
Program Library

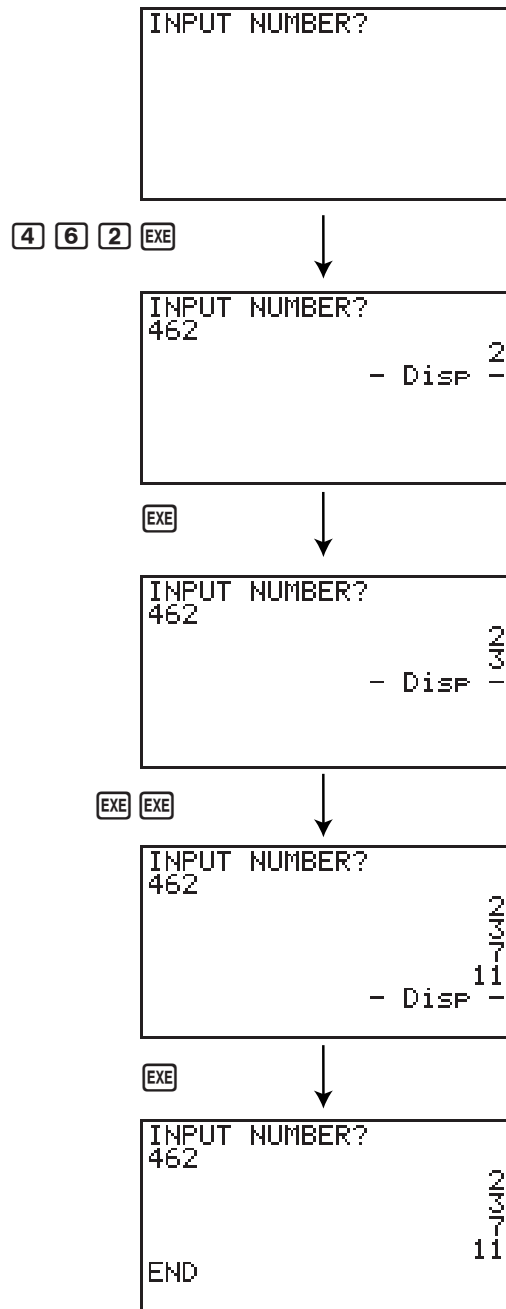

## Program Name Arithmetic-Geometric Sequence Differentiation

### Description

After input sequence terms 1, 2, and 3, this program determines whether it is an arithmetic sequence or geometric sequence based on the differences and ratios of the terms.

### Purpose

This program determines whether a specific sequence is an arithmetic sequence or geometric sequence.

• • • • •

**Example 1** 5, 10, 15, ... Arithmetic sequence

• • • • •

**Example 2** 5, 10, 20, ... Geometric sequence

```
ClrText↵
"A1"?→A↵
"A2"?→B↵
"A3"?→C↵
B-A→D↵
C-B→E↵
If D=E↵
Then ClrText↵
"AN = A1 + (N-1)D"↵
" "↵
"A1 ="↵
"D ="↵
Locate 6,3,A↵
Locate 6,4,D↵
IfEnd↵
B/A→F↵
C/B→G↵
If F=G↵
Then ClrText↵
"AN = A1×r^(N-1)"↵
" "↵
"A1 ="↵
"r ="↵
Locate 6,3,A↵
Locate 6,4,F↵
IfEnd↵
"END"
```



**Example 1**

```
A1?
```

5 EXE



```
A1?  
5  
A2?
```

1 0 EXE



```
A1?  
5  
A2?  
10  
A3?
```

1 5



```
A1?  
5  
A2?  
10  
A3?  
15
```

EXE



```
AN = A1 + (N-1)D  
A1 = 5  
D = 5  
- Disp -
```

**Example 2**

```
A1?
```

5 EXE



```
A1?  
5  
A2?
```

1 0 EXE



```
A1?  
5  
A2?  
10  
A3?
```

2 0



```
A1?  
5  
A2?  
10  
A3?  
20
```

EXE



```
AN = A1 × r^(N-1)  
A1 = 5  
r = 2  
END
```





## Program Name

## Ellipse

### Description

This program displays a number table of the following values based on input of the foci of an ellipse, the sum of the distance between the loci and foci, and the pitch (step size) of X.

Y1: Coordinate values of upper half of ellipse

Y2: Coordinate values of lower half of ellipse

Y3: Distances between right focus and loci

Y4: Distances between left focus and loci

Y5: Sum of Y3 and Y4

Next, the program plots the foci and values in Y1 and Y2.

### Purpose

This program shows that the sums of the distances between the loci and two foci of an ellipse are equal.

```

Do↓
ClrText↓
"FOCUS (C,0),(-C,0)"↓
"C="?→C↓
"SUM DISTANCE"?→D↓
LpWhile 2Abs C≥D Or D≤0↓
D/2→A↓
√(A²-C²)→B↓
Y=Type↓
"B√(1-X²/A²)"→Y1↓
"-Y1"→Y2↓
"√((X-C)²+Y1²)"→Y3↓
"√((X+C)²+Y1²)"→Y4↓
"Y3+Y4"→Y5↓
For 1→E To 20↓
If E≤5↓
Then G SelOn E↓
Else G SelOff E↓
IfEnd↓
Next↓
-Int A→F Start↓
Int A→F End↓
"F pitch"?→F pitch↓
DispF-Tbl↓
ClrGraph↓
1.2A→Xmax↓
-1.2A→Xmin↓
1.2B→Ymax↓
-1.2B→Ymin↓
G SelOff 3↓
G SelOff 4↓
G SelOff 5↓
DispF-Tbl↓
DrawFTG-Plt↓
PlotOn C,0↓
PlotOn -C,0↓
"END"

```



8-8-6  
Program Library

```
FOCUS (C,0),(-C,0)
C=?
3
```



```
FOCUS (C,0),(-C,0)
C=?
3
SUM DISTANCE?
10
```



```
FOCUS (C,0),(-C,0)
C=?
3
SUM DISTANCE?
10
F Pitch?
1
```



| X  | Y1    | Y2     | Y3  |
|----|-------|--------|-----|
| -5 | 0     | 0      | 8   |
| -4 | 2.4   | -2.4   | 7.4 |
| -3 | 3.2   | -3.2   | 6.8 |
| -2 | 3.666 | -3.666 | 6.2 |

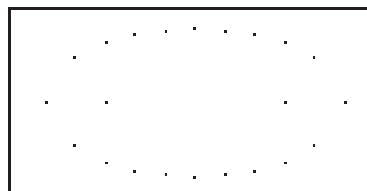

## Program Name

## Rotation

### Description

This program draws an angle at the coordinate defined by an input vertex, and then rotates it to a specified angle around the vertex.

### Purpose

This program demonstrates coordinate transformation using a matrix.

### Important!

Deg must be set as the angle unit for this program.

```

Do↓
ClrText↓
"VERTEX NUMBER"?)→A↓
LpWhile A≤0 Or Frac A≠0↓
{2,A}→Dim Mat A↓
ClrGraph↓
For 1→B To A↓
Text 1,1,"VERTEX"↓
Text 1,30,B↓
If B=1↓
Then Plot ↓
PlotOn X,Y↓
X→Mat A[1,B]↓
Y→Mat A[2,B]↓
Else Plot C,D↓
F-Line C,D,X,Y↓
X→Mat A[1,B]↓
Y→Mat A[2,B]↓
IfEnd↓
Mat A[1,B]→C↓
Mat A[2,B]→D↓
Next↓
Mat A[1,1]→E↓
Mat A[2,1]→F↓
F-Line C,D,E,F↓
Text 1,1,"--AXIS--"↓
Plot ↓
PlotOn X,Y↓
X→C↓
Y→D↓
A→Dim List 1↓
A→Dim List 2↓
Fill(C,List 1)↓
Fill(D,List 2)↓
List→Mat(List 1,List 2)↓
Trn Mat Ans→Mat C↓
Mat A-Mat C→Mat A↓
ClrText↓
"ANGLE"?)→E↓
[[cos E,-sin E][sin E,cos E]→Mat B↓
Mat B×Mat A→Mat D↓
Mat D+Mat C→Mat D↓
If A=1↓
Then PlotOn Mat D[1,1],Mat D[2,1]↓
Else For 1→B To A-1↓
Mat D[1,B]→F↓
Mat D[2,B]→G↓
Mat D[1,B+1]→H↓
Mat D[2,B+1]→I↓
F-Line F,G,H,I↓
Next↓
If A>2↓
Then Mat D[1,1]→F↓
Mat D[2,1]→G↓

```

```

F-Line H,I,F,G↓
IfEnd↓
IfEnd↓
Text 1,1,"--END--"

```



8-8-8  
Program Library

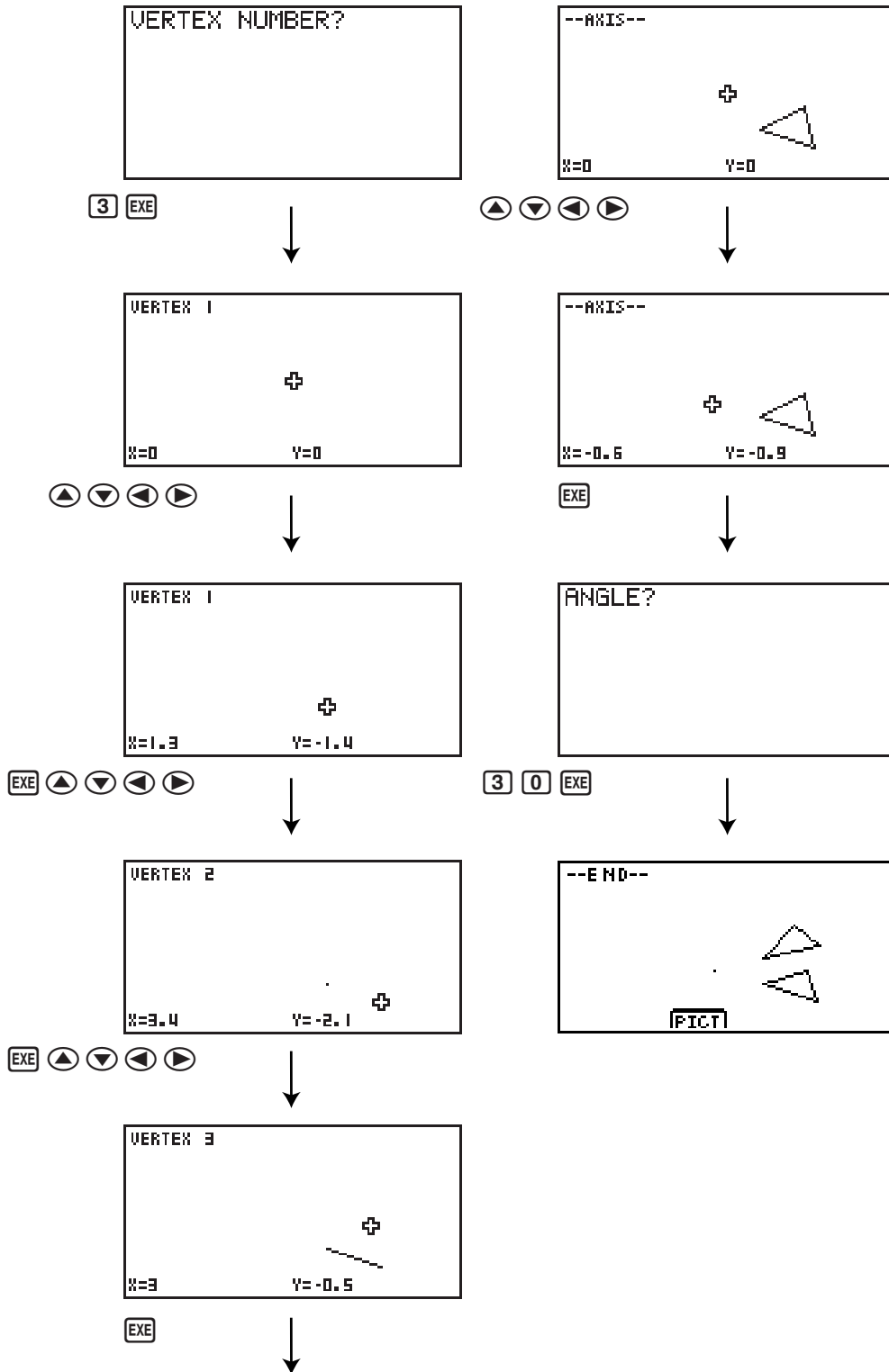

## Program Name Interior Angles and Surface Area of a Triangle

### Description

This program calculates the interior angles and surface area of a triangle defined by input coordinates for angles A, B, and C.

### Purpose

This program calculates the interior angles and surface area of a triangle defined by coordinates for angles A, B, and C.

### Important!

Inputting the same coordinates for any two angles (A, B, C) causes an error.

```

ClrText↓
"WHICH ANGLE?"↓
" 1.Deg"↓
" 2.Rad"↓
" 3.Gra"↓
Do↓
Getkey↓
LpWhile ((Ans=72) Or (Ans=62) Or (Ans=52))=0↓
If Ans=72↓
Then 1→θ↓
Deg↓
" "↓
"-Deg-Deg-Deg-Deg-Deg-"↓
IfEnd↓
If Ans=62↓
Then 2→θ↓
Rad↓
" "↓
"-Rad-Rad-Rad-Rad-Rad-"↓
IfEnd↓
If Ans=52↓
Then 3→θ↓
Gra↓
" "↓
"-Gra-Gra-Gra-Gra-Gra-"↓
IfEnd↓
"AX"→A↓
"AY"→B↓
"BX"→C↓
"BY"→D↓
"CX"→E↓
"CY"→F↓
A-C→G↓
B-D→H↓
C-E→I↓
D-F→J↓
E-A→K↓
F-B→L↓
-GI-HJ→M↓
-IK-JL→N↓
-KG-LH→O↓
√(G²+H²)→P↓
√(I²+J²)→Q↓
√(K²+L²)→R↓
M/PQ→S↓
N/QR→T↓
O/PR→U↓
cos⁻¹ S→V↓
cos⁻¹ T→W↓
cos⁻¹ U→X↓
PQ√(1-S²)→Y↓
ClrText↓
" <ABC ="↓
Locate 9,1,V↓

```

```

" <ACB ="↓
Locate 9,2,W↓
" <BAC ="↓
Locate 9,3,X↓
If θ=1↓
Then " (Deg)"↓
IfEnd↓
If θ=2↓
Then " (Rad)"↓
IfEnd↓
If θ=3↓
Then " (Gra)"↓
IfEnd↓
" AREA ="↓
Locate 9,5,Y/2↓
" "↓
"END"

```





# Chapter

# 9



## System Settings Menu

Use the system settings menu to view system information and make system settings. The system settings menu lets you do the following.

- View memory usage information
- Make contrast settings
- Make Auto Power Off settings
- Specify the system language
- Reset the calculator
- Tutorial Lock

### 9-1 Using the System Settings Menu

### 9-2 Memory Operations

### 9-3 System Settings

### 9-4 Reset

### 9-5 Tutorial Lock



## 9-1 Using the System Settings Menu

From the Main Menu, enter the **SYSTEM** Mode and display the following menu items.

```
System Manager
F1:Memory Usage
F2:Contrast
F3:Auto Power Off
F4:Language
F5:Reset
F6:Tutorial Lock
Meml <=> |APO|Lang|Reset|T-Lock|
```

- **F1** (Mem) ... {display current memory status and delete data stored in memory}
- **F2** (<=>) ... {display contrast adjustment}
- **F3** (APO) ... {Auto Power Off time setting}
- **F4** (Lang) ... {system language}
- **F5** (Reset) ... {system reset operations}
- **F6** (T-Lock) ... {Tutorial Lock}





## 9-2 Memory Operations

Use the Mem (Memory Usage) item to view current memory status and to delete certain data stored in memory.

While the initial System Settings Mode screen is displayed, press **[F1]** (Mem) to display the Memory usage screen.

| Memory Usage      |                |
|-------------------|----------------|
| Program           | : 0            |
| Matrix            | : 83           |
| Statistics        | : 376          |
| List File         | : 216          |
| V= Data           | : 214          |
| 137337 Bytes Free |                |
| <b>[DEL]</b>      | <b>[DEL/A]</b> |

### • To delete data



1. Use the **▲** and **▼** cursor keys to move the highlighting to the memory item whose data you want to delete.
2. Press **[F1]** (DEL).<sup>\*1</sup>
3. If you selected List File, Graph Memory, V-Win Memory, Picture or H-Copy Memory in step 1, a menu appears so you can select which data you want to delete.  
Input a number to specify the data and then press **[EXE]**.
4. In response to the confirmation message that appears, press **[EXE]** (Yes) to delete the data you specified, or **[ESC]** (No) to cancel.

Pressing **[ESC]** or **[SHIFT]** **[ESC]** (QUIT) returns to the initial System Settings Mode screen.





<sup>\*1</sup> Pressing **[F6]** (DEL • A) deletes all the data in the currently selected memory item.

• **To view memory usage information**

Use  and  to move the highlighting and view the amount of memory (in bytes) used for storage of each type of data.

The following table shows all of the data types that appear on the memory status screen.

| Data Type     | Meaning                                                              |
|---------------|----------------------------------------------------------------------|
| Program       | Program data                                                         |
| Matrix        | Matrix memory data                                                   |
| Statistics    | Statistical calculations and graphs                                  |
| List File     | List data                                                            |
| Y=Data        | Graph functions                                                      |
| Draw Memory   | Graph drawing conditions (View Window, enlargement/reduction factor) |
| Graph Memory  | Graph memory data                                                    |
| V-Win Memory  | View Window memory data                                              |
| Picture       | Picture memory data                                                  |
| Table         | Function Table & Graph data                                          |
| Dynamic Graph | Dynamic Graph data                                                   |
| Recursion     | Recursion Table & Graph data                                         |
| Equation      | Equation calculation data                                            |
| Algebra       | Algebra variable data                                                |
| Alpha Memory  | Alpha memory data                                                    |
| Function Mem  | Function memory data                                                 |
| H-Copy Memory | Screen shot transfer memory                                          |
| System        | System Variable data                                                 |

Pressing  or   (QUIT) returns to the initial System Settings Mode screen.



## 9-3 System Settings

### ■ Contrast Adjustment

Use the ◀▶ (Contrast) item to adjust display contrast.

While the initial System Settings Mode screen is displayed, press **F2**(◀▶) to display the Contrast Adjustment screen.

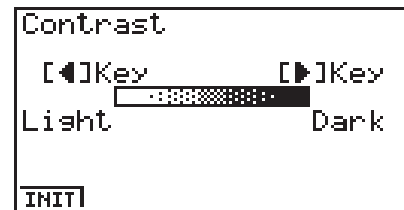

- The ▶ cursor key makes display contrast darker.
- The ◀ cursor key makes display contrast lighter.
- **F1**(INIT) returns display contrast to its initial default.

Pressing **ESC** or **SHIFT** **ESC** (QUIT) returns to the initial System Settings Mode screen.

You can adjust contrast while any screen besides the Main Menu is on the display by pressing **SHIFT** and then ▶ or ◀. To exit contrast adjustment, press **SHIFT** again.

### ■ APO Settings

You can specify either six minutes or 60 minutes as the Auto Power Off trigger time. The initial default setting is six minutes.

While the initial System Settings Mode screen is displayed, press **F3**(APO) to display the APO Setting screen.

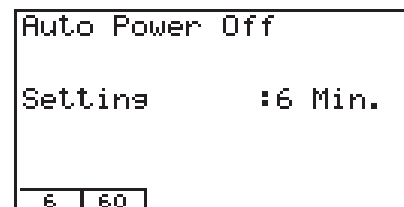

- **F1**(6) ... 6 minutes
- **F2**(60) ... 60 minutes

Pressing **ESC** or **SHIFT** **ESC** (QUIT) returns to the initial System Settings Mode screen.



## ■ System Language Setting

Use Lang to specify the display language for built-in applications. You can also use add-ins to install various other languages.

1. From the initial System Setting Mode screen, press **F4** (Lang) to display the system language setting screen.



```
Language
[English]
English
Español
Deutsch
Français
Italiano
sel
```

2. Use the **▲** and **▼** cursor keys to select the language you want, and then press **F1** (Sel).
3. The pop up window appears using the language you selected. Check the contents and then press **ESC**.

Press **ESC** or **SHIFT ESC** (QUIT) to return to the initial System Setting Mode screen.



# Installing a language with an add-in causes the installed language to be selected as the system language automatically. Changing the

system language from an add-in language to a built in language causes the add-in language to be deleted.

## 9-4 Reset

1. While the initial System Settings Mode screen is displayed, press **[F5]** (Reset) to display the Reset Menu screen.

```
*****  
*      RESET      *  
*****  
F1:Setup Data  
F2:Main Memories  
F3:Storage Memories  
F4:Initialize  
S/U|Main|Strg|Init|
```

- **[F1]** (S/U) ... {set up initialization}
  - **[F2]** (Main) ... {main memory data clear}
  - **[F3]** (Strg) ... {storage memory data and main memory data clear}
  - **[F4]** (Init) ... {all memory clear}
2. Press the function key that corresponds to the reset operation you want to perform.
  3. In response to the confirmation message that appears, press **[EXE]** (Yes) to perform the reset operation you specified, or **[ESC]** (No) to cancel.
  4. A message appears to let you know when the reset operation is complete.  
Press **[MENU]** to return to the Main Menu.



## 9-5 Tutorial Lock

You can temporarily disable the Tutorial Mode (for 180 minutes).

1. From the initial System Setting Mode screen, press **[F6]** (T-Lock) to display the Tutorial Lock screen.

```
Tutorial Lock
Tutorial Is Enabled
Lock
```

2. Pressing **[F1]** (Lock) displays the pop-up menu.

```
Tutorial Lock
Disable Tutorial?
Yes:[EXE]
No:[ESC]
Lock
```

3. Pressing **[EXE]** (Yes) locks the Tutorial Mode so it cannot be used for 180 minutes.

```
Tutorial Lock
Tutorial Is Disabled
Remainder :180Min.
Lock
```

Pressing **[ESC]** or **[SHIFT][ESC]** (QUIT) returns to the initial System Settings Mode screen.

Attempting to enter the Tutorial Mode while Tutorial Lock is enabled displays a screen that shows the remaining Tutorial Lock time.

```
Tutorial
Tutorial Is Disabled
Remainder :172Min.
```

Press **[ESC]** to return to the Main Menu.



# Chapter 10

## Data Communications

This chapter tells you everything you need to know to transfer programs between two CASIO Power Graphic calculators connected using the cable that is equipped as a standard accessory.

You can also use the cable to connect the calculator to a CASIO Label Printer to print screen data.

To transfer data between a calculator and a personal computer, you need to purchase the separately available CASIO FA-123 Connection Kit.

**10**

- 10-1 Connecting Two Units**
- 10-2 Connecting the Unit with a CASIO Label Printer**
- 10-3 Connecting the Unit to a Personal Computer**
- 10-4 Performing a Data Communication Operation**
- 10-5 Data Communications Precautions**
- 10-6 Sending a Screen Shot**
- 10-7 Add-ins**
- 10-8 MEMORY Mode**

## 10-1 Connecting Two Units

The following procedure describes how to connect two units with the connecting cable that comes equipped as a standard accessory.

---

• **To connect two units**

1. Check to make sure that the power of both units is off.
2. Remove the covers from the connectors of the two units.
3. Connect the two units using the cable.

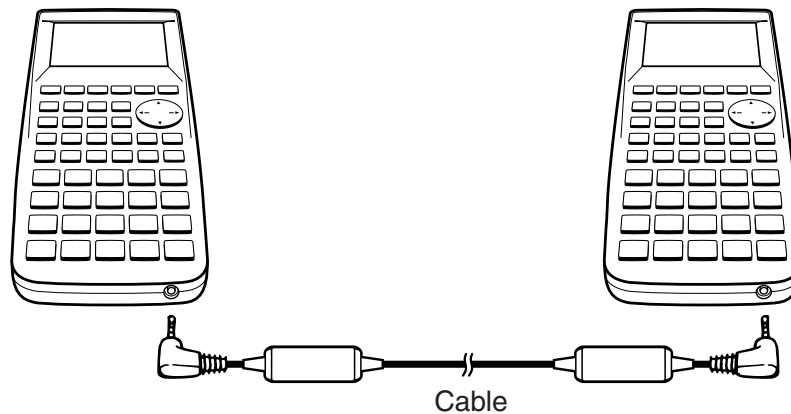

# Be sure you keep the connector covers in a safe place so you can replace them after you finish your data communications.

# Keep the connectors covered when you are not using them.



## 10-2 Connecting the Unit with a CASIO Label Printer

After you connect the unit to a CASIO Label Printer with cable, you can use the Label Printer to print screen shot data from the unit (see 10-6 Sending a Screen Shot). See the user's guide that comes with your Label Printer for details on how to perform this operation.

- The operation described above can be performed using the following Label Printer models: KL-2000, KL-2700, KL-8200, KL-8700 (as of February 1999).

### •To connect the unit to a Label Printer

1. Check to make sure that the power of the unit and the Label Printer is off.
2. Connect the cable to the Label Printer.
3. Remove the cover from the connector of the unit.
4. Connect the other end of the cable to the unit.
5. Turn on the power of the unit, followed by the Label Printer.

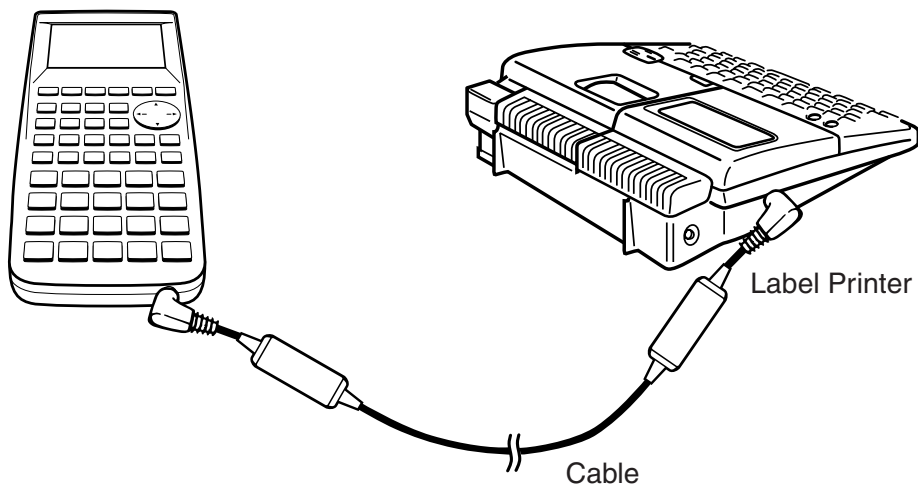

- After you finish data communications, turn off power in the sequence: the unit first, and then the Label Printer. Finally, disconnect the equipment.



# Be sure you keep the connector cover in a safe place so you can replace it after you

finish your data communications.



## 10-3 Connecting the Unit to a Personal Computer

To transfer data and screen shots between the unit and a personal computer, you must connect them through a separately available CASIO FA-123 Connection Kit.

For details on operation, the types of computer that can be connected, and hardware limitations, see the user's manual that comes with the FA-123.

Some types of data may not be able to be exchanged with a personal computer.

---

### • To connect the unit to a personal computer

1. Check to make sure that the power of the unit and the personal computer is off.
2. Connect the personal computer to the FA-123 Connection Kit.
3. Remove the cover from the connector of the unit.
4. Connect the unit to the FA-123 Connection Kit.
5. Turn on the power of the unit, followed by the personal computer.

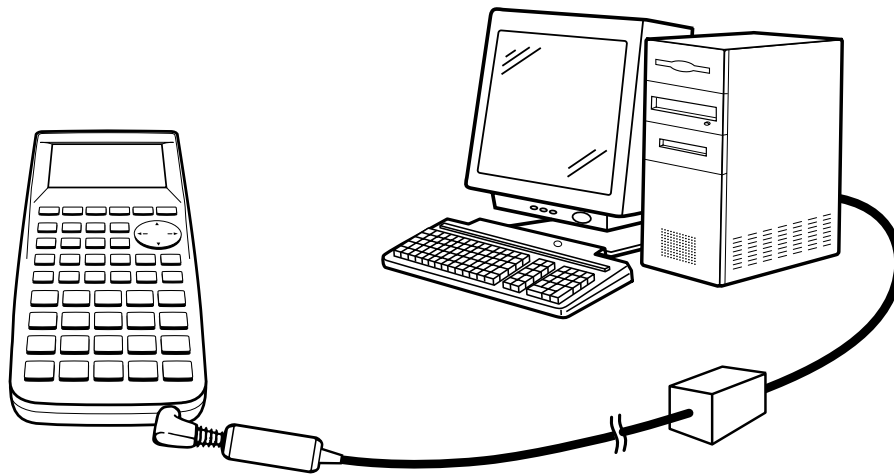

- After you finish data communications, turn off power in the sequence: the unit first, and then the personal computer. Finally, disconnect the equipment.



# Be sure you keep the connector cover in a safe place so you can replace it after you

finish your data communications.



## 10-4 Performing a Data Communication Operation

From the Main Menu, enter the LINK Mode. The following data communication main menu appears on the display.

```
Data Communication

F1:Transmit
F2:Receive
TRNS|RCV|
```

- {TRNS}/{Recv} ... menu of {send settings}/{receive settings}

Communications parameters are fixed at the following settings.

- Speed (BPS): 38.4 kbps (sending a data)  
9,600bps (sending a screen shot)
- Parity (PARITY): NONE

---

### ■ Performing a Data Transfer Operation

Connect the two units and then perform the following procedures.

#### Receiving unit

To set up the calculator to receive data, press **[F2]** (Recv) while the data communication main menu is displayed.

```
Receiving...

Cancel:[AC]
```

The calculator enters a data receive standby mode and waits for data to arrive. Actual data receive starts as soon as data is sent from the sending unit.



### Sending unit

To set up the calculator to send data, press **[F1]**(TRNS) while the data communication main menu is displayed.

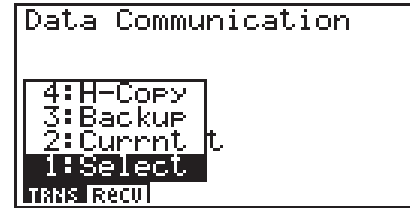

Press the number key that corresponds to the type of data you want to send.

- **{Select}** ... {selects data items and sends them}
- **{Curmnt}** ... {selects data items from among previously selected data items and sends them}
- **{Backup}** ... {sends all memory contents, including mode settings}
- **{H-Copy}** ... {selects H-Copy screen shot data and sends it}

---

#### • To send selected data items

Press **[1]** (Select) or **[2]** (Curmnt) to display a data item selection screen.

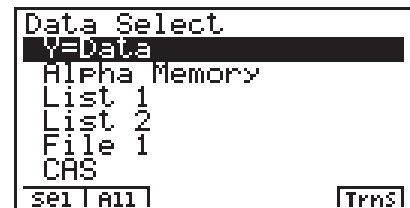

- **{Sel}** ... {selects data item where cursor is located}
- **{All}** ... {selects all data}
- **{Trns}** ... {sends selected data items}

Use the **▲** and **▼** cursor keys to move the cursor to the data item you want to select and press **[F1]**(Sel) to select it. Currently selected data items are marked with "▶". Pressing **[F6]** (Trns) sends all the selected data items.

- To deselect a data item, move the cursor to it and press **[F1]**(Sel) again.

Only items that contain data appear on the data item selection screen. If there are too many data items to fit on a single screen, the list scrolls when you move the cursor to the bottom line of the items on the screen.



### •To execute a send operation

After selecting the data items to send, press **F6** (Trns). A message appears to confirm that you want to execute the send operation.

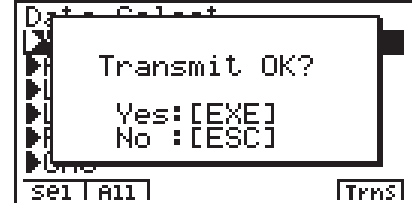

- **EXE** (Yes) ... sends data
- **ESC** (No) ... returns to data selection screen

Press **EXE** (Yes) to send the data.

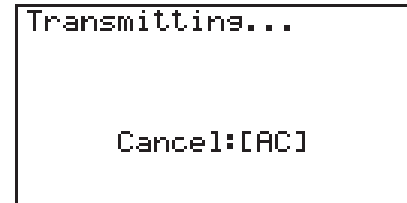

- You can interrupt a data operation at any time by pressing **AC**.

The following shows what the displays of the sending and receiving units look like after the data communication operation is complete.

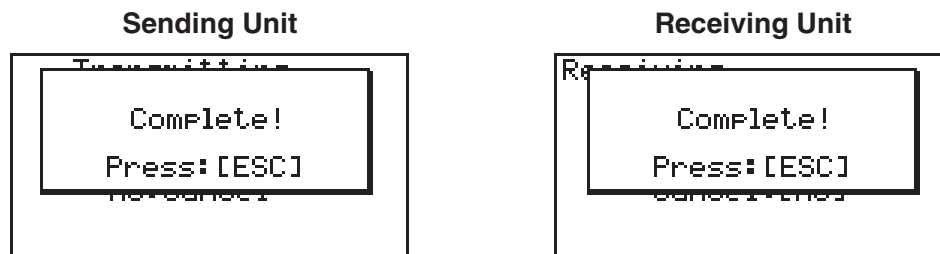

Press **ESC** to return to the data communication main menu.



### • To send backup data

This operation allows you to send all memory contents, including mode settings.

While the transmit data type selection menu is on the screen, press **[3]** (Backup), to display the screen shown below.

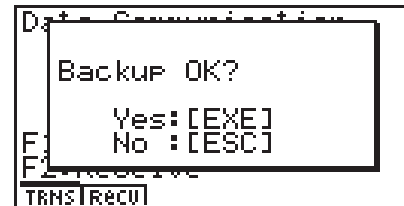

Press **[EXE]** (Yes) to start the send operation.

The following shows what the displays of the sending and receiving units look like after the data communication operation is complete.

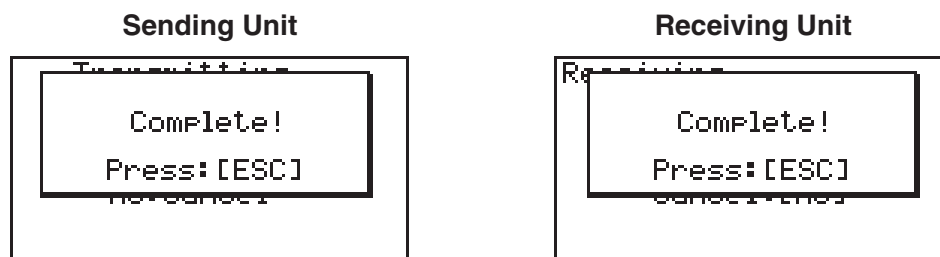

Press **[ESC]** to return to the data communication main menu.



# Data can become corrupted, necessitating a RESET of the receiving unit, should the connecting cable become disconnected during data transfer.

Make sure that the cable is securely connected to both units before performing any data communication operation.



## 10-5 Data Communications Precautions

The following are the types of data items that can be sent.

| Data Item                | Contents                                                                                | Overwrite Check* <sup>1</sup> | Password Check* <sup>2</sup> |
|--------------------------|-----------------------------------------------------------------------------------------|-------------------------------|------------------------------|
| Program names            | Program contents<br>(All programs are listed.)                                          | Yes                           | Yes                          |
| Mat <i>n</i>             | Matrix memory (A to Z) contents                                                         | Yes                           |                              |
| List <i>n</i>            | List memory (1 to 20) contents                                                          | Yes                           |                              |
| List File <i>n</i>       | List file memory (1 to 20) contents                                                     | Yes                           |                              |
| Y=Data                   | Graph expressions, graph write/<br>non-write status, V-Window contents,<br>zoom factors | No                            |                              |
| Graph Memory <i>n</i>    | Graph memory (1 to 20) contents                                                         | Yes                           |                              |
| V-Win Memory <i>n</i>    | V-Window memory contents                                                                | No                            |                              |
| Picture <i>n</i>         | Picture (graph) memory (1 to 20) data                                                   | No                            |                              |
| Dynamic Graph            | Dynamic Graph functions                                                                 | Yes                           |                              |
| Equation                 | Equation calculation coefficient values                                                 | No                            |                              |
| Alpha Memory             | Variable memory contents                                                                | No                            |                              |
| Function Mem             | Function memory contents                                                                | No                            |                              |
| CAS                      | CAS formula data contents                                                               | No                            |                              |
| Algebra                  | Algebra data contents                                                                   | No                            |                              |
| H-Copy Memory <i>n</i>   | H-Copy (screen shot) Memory data<br>(1 to 20)                                           | No                            |                              |
| Add-in application names | Add-in application data<br>(All add-in applications are listed.)                        | No                            |                              |

\*<sup>1</sup> No overwrite check: If the receiving unit already contains the same type of data, the existing data is overwritten with the new data.

With overwrite check: If the receiving unit already contains the same type of data, a message appears to ask if the existing data should be overwritten with the new data.

Data item name —

```

Overwrite Check
[Mat A ]
Already Exists
Overwrite OK?
F1: Yes
F6 :No
ESC:Cancel
YES | NO |

```



- **F1** (YES) ... {replaces the receiving unit's existing data with the new data}
- **F6** (NO) ... {skips to next data item}

\*2 With password check: If a file is password protected, a message appears asking for input of the password.

Name of password protected file —

Password input field —

|              |       |
|--------------|-------|
| Program Name | [AA ] |
| Password?    | [ ]   |
|              | [ ]   |

**SVBL**

After inputting the password, press **EXE**.

Note the following precautions whenever you perform data communications.

- An error occurs whenever you try to send data to a receiving unit that is not yet standing by to receive data. When this happens, press **ESC** to clear the error and try again, after setting up the receiving unit to receive data.
- An error occurs whenever the receiving unit does not receive any data approximately six minutes after it is set up to receive data. When this happens, press **ESC** to clear the error.
- An error occurs during data communications if the cable becomes disconnected, if the parameters of the two units do not match, or if any other communications problem occurs. When this happens, press **ESC** to clear the error and correct the problem before trying data communications again. If data communications are interrupted by **ESC** key operation or an error, any data successfully received up the interruption will be in the memory of the receiving unit.
- An error occurs if the receiving unit memory becomes full during data communications. When this happens, press **ESC** to clear the error and delete unneeded data from the receiving unit to make room for the new data, and then try again.





## 10-6 Sending a Screen Shot

Use the following procedures to send a hardcopy of the screen directly to a connected personal computer (or CASIO Label Printer) or to save a screen shot in memory to send later. Screen shots can also be sent to a CASIO Label Printer.

Use the LINK Mode set up (**CTRL** **F3** (SET UP)) to specify whether you want to send the screen shot now or save it in memory.

### • H-Copy

- {Dirct}/{Mem} ..... {direct send}/{save}

---

### • To send a screen shot directly to a connected computer (or CASIO Label Printer) (Direct)

1. Connect the unit to the computer (or CASIO Label Printer).  
On the computer (or CASIO Label Printer), perform the procedures required to set it up to receive data.
2. Display the screen you want to send.
3. Press **CTRL** **F6** (H-COPY).

---

### • To save a screen shot in memory (Memory)

1. Display the screen you want to save.
2. Press **CTRL** **F6** (H-COPY).
  - You can store up to 20 screen shots in memory. Saved screen shots are automatically assigned file names from Hcopy1 to Hcopy20.



- # You cannot send the following types of screens to a computer or a Label Printer.
- The screen that appears while a data communication operation is in progress.
  - A screen that appears while a calculation is in progress.
  - The screen that appears following the reset operation.
  - The low battery message.

- # The flashing cursor is not included in the screen image that is sent from the unit.
- # You cannot use 6mm wide tape to print a screen shot of a graph.



● **To send a saved screen shot to a computer or CASIO Label Printer**

1. Connect the unit to the computer (or CASIO Label Printer). On the computer (or CASIO Label Printer), perform the procedures required to set it up to receive data.
2. In the LINK Mode, press **[F1]**(TRNS) **[4]** (H-Copy) to display of list of screen shots in memory.

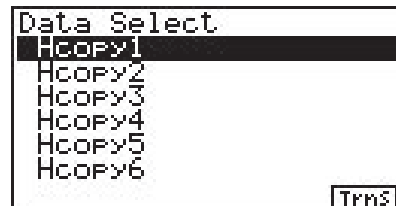

3. Use the **▲** and **▼** cursor keys to highlight the name of the screen shot you want to send, and then press **[F6]**(Trns).

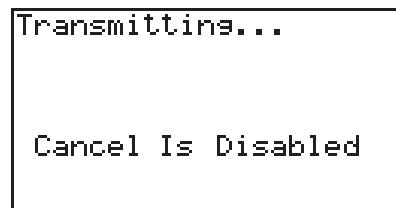

## 10-7 Add-ins

Add-in capabilities let you install separately available applications and other software to tailor the calculator to suit your particular needs.

Add-ins are installed from a computer using the data communication described on page 10-4-1.

The following are the types of software that can be installed as add-ins.

- **Add-in Application**

After you install an application, its icon appears in the Main Menu, and you can run it just as you would a built-in application.

- **Built-in Application Upgrades**

These are upgrades for the applications that are pre-programmed in the calculator's ROM. The icon of the upgrade replaces the icon of the original application.

- **On-screen Message Language Data**

This data required to display on-screen messages in other languages. Installing this data causes all on-screen messages to appear in the corresponding language.



## 10-8 MEMORY Mode

This calculator has two separate memory areas: a “current area” and a “storage area.” The current area is a work area where you can perform input data, perform calculations and run programs. Data in the current area is relatively safe, but it can be deleted when batteries go dead and when you perform a full reset.

The storage area uses “flash memory,” so data is safe even when power is interrupted. Normally, you would use the storage area for data you need to store securely for long periods and load into the current area only when you need it.

Use the MEMORY Mode to transfer data between the current area and storage area, and to perform other memory management operations.

From the Main Menu, select the **MEMORY** icon to enter the MEMORY Mode and display its initial screen.

```
Memory Manager
F1:Program Files
F2:Backup
F3:Optimization
PROG|BACK|OPT|
```

- {**PROG**} ..... {program file save, load, delete, search}
- {**BACK**} ..... {current area data backup and restore}
- {**OPT**} ..... {optimization of the storage area}

---

### ■ Storing and Loading Program Files

Use the following procedures to store a current area program file into the storage area, and to load a file from the storage area into the current area.



• **To store a program file into the storage area**

1. On the initial MEMORY Mode screen press **[F1]**(PROG).

- This displays a list of program files that are in the current area.\*1

| Current Area                         |      |
|--------------------------------------|------|
| HHH                                  | : 56 |
| SAMPLE                               | : 37 |
| TEST                                 | : 54 |
| 146765 BytesFree                     |      |
| SEL   DEL   DELA   SRC   SAVE   STRG |      |

2. Select the program file you want to store.

- Use the cursor **▲** and **▼** keys to highlight the name of the program file you want to store, and then press **[F1]**(SEL).

3. Press **[F5]** (SAVE).

The message “Complete!” appears when the store operation is finished.

Press **[ESC]** to return to the screen displayed in step 1.

A “Memory ERROR” occurs and the store operation is terminated if the storage area becomes full.

The following message appears if there is already a program file in the storage area with the same name as the program file you are trying to save.

| Current Area   |  |
|----------------|--|
| [SAMPLE ]      |  |
| Already Exists |  |
| Overwrite OK?  |  |
| Yes: [EXE]     |  |
| No : [ESC]     |  |

Press **[EXE]** (Yes) to save the new program file, or **[ESC]** (No) to cancel the save operation.



\*1 The screen appears as shown below if there are no program files in the current area when you start the save operation.

| Current Area |
|--------------|
| No Programs  |

• **To load a program file from the storage area**

1. On the initial MEMORY Mode screen press **[F1]** (PROG).

2. Press **[F6]** (STRG).

- This displays a list of program files that are in the storage area. \*1

```
Storage Area
SAMPLE : 37
XXX : 28

786175 BytesFree
SEL | DEL | DELA | SRC | LOAD | CRNT
```

3. Select the program file you want to load.

- Use the cursor **▲** and **▼** keys to highlight the name of the program file you want to load, and then press **[F1]** (SEL).

4. Press **[F5]** (LOAD).

The message “Complete!” appears when the load operation is finished.

Press **[ESC]** to return to the screen displayed in step 1.

A “Memory ERROR” occurs and the load operation is terminated if the current area becomes full.

The following message appears if there is already a program file in the current area with the same name as the program file you are trying to load.

```
Storage Area
[SAMPLE ]
Already Exists
Overwrite OK?
Yes:[EXE]
No:[ESC]
```

Press **[EXE]** (Yes) to load the new program file, or **[ESC]** (No) to cancel the load operation.



\*1 The screen appears as shown below if there are no program files in the storage area when you start the load operation.

```
Storage Area

No Programs
```

## ■ Deleting Program Files

Use the following procedures to delete individual files or all files in the current area or storage areas.

### • To delete a current area program file

1. On the initial MEMORY Mode screen press **[F1]** (PROG).
  - This displays a list of program files that are in the current area.
2. Use the cursor **▲** and **▼** keys to highlight the name of the program file you want to delete, and then press **[F2]** (DEL).

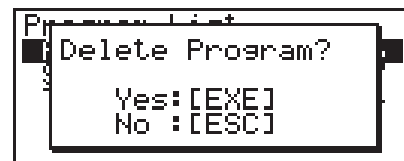

- Press **[EXE]** (Yes) to delete the program file.
- Press **[ESC]** (No) to cancel the delete operation.

### • To delete a storage area program file

1. On the initial MEMORY Mode screen press **[F1]** (PROG).
2. Press **[F6]** (STRG).
  - This displays a list of program files that are in the storage area.
3. Use the cursor **▲** and **▼** keys to highlight the name of the program file you want to delete, and then press **[F2]** (DEL).

- Press **[EXE]** (Yes) to delete the program file.
- Press **[ESC]** (No) to cancel the delete operation.

### • To delete all the program files in the current area

1. On the initial MEMORY Mode screen press **[F1]** (PROG).
  - This displays a list of program files that are in the current area.
2. Press **[F3]** (DEL·A).

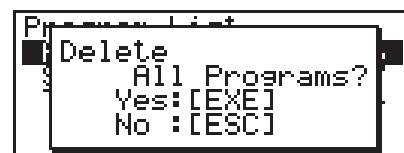

- Press **[EXE]** (Yes) to delete all the program files in the current area.
- Press **[ESC]** (No) to cancel the delete operation.



• **To delete all the program files in the storage area**

1. On the initial MEMORY Mode screen press **[F1]** (PROG).
  2. Press **[F6]** (STRG).
    - This displays a list of program files that are in the storage area.
  3. Press **[F3]** (DEL•A).
- Press **[EXE]** (Yes) to delete all the program files in the storage area.
  - Press **[ESC]** (No) to cancel the delete operation.

■ **Searching for a Program File**

Use the following procedures to search for a specific program file in the current area or in the storage area.

• **To search for a program file in the current area** \*1



**Example** To search for all program files in the current area whose names begin with the letter “C”

1. On the initial MEMORY Mode screen press **[F1]** (PROG).
  - This displays a list of program files that are in the current area.
2. Press **[F4]** (SRC).
  - Input the letter “C” for the keyword.



- The first program file name that begins with the letter “C” appears highlighted on display.



\*1 You can input up to eight characters for the keyword.

The message “Not Found” appears if there are no program file names that match your keyword.



---

• **To search for a program file in the storage area**



**Example** To search for all program files in the storage area whose names begin with the letter “S”

1. On the initial MEMORY Mode screen press **F1** (PROG).
2. Press **F6** (STRG).
  - This displays a list of program files that are in the storage area.
3. Press **F4** (SRC).
  - Input the letter “S” for the keyword.

- The first program file name that begins with the letter “S” appears highlighted on display.

| Storage Area |   |    |
|--------------|---|----|
| SAMPLE       | : | 37 |
| STORAGE      | : | 44 |
| TEST         | : | 54 |

Press **▼** or **F1** (SRC) to highlight the next file name that matches your keyword.

Press **▲** to highlight the previous file name that matches your keyword.

The message “Not Found” appears if there are no program file names that match your keyword.

Press **ESC** to exit the search.



## ■ Backing Up Current Area Data

You can back up all the data in the current area and store it in the storage area. Later you can restore the backed up data to the current area when necessary.

### • To back up current area data

1. On the initial MEMORY Mode screen press **[F2]** (BACK).
  - Screen A appears if there is already backup data in the storage area. Screen B appears if there is no backup data in the storage area.

Screen A

```
Backup
Backup Data Exists
  In Storage Area
-----
SAVE|LOAD|DEL|
```

Screen B

```
Backup
No Backup Data
  In Storage Area
-----
SAVE|
```

2. Press **[F1]** (SAVE) to backup the data.

The message "Complete!" appears when the backup operation is finished.

Press **[ESC]** to return to the screen displayed in step 1.

The following message appears if there is already backup data in the storage area.

```
Backup
Overwrite OK?
Yes:[EXE]
No :[ESC]
```

Press **[EXE]** (Yes) to back up the data, or **[ESC]** (No) to cancel the backup operation.

A "Memory ERROR" occurs when there is not enough space available in the storage area to complete the backup operation.



---

### • To restore backup data to the current area

1. On the initial MEMORY Mode screen press **[F2]** (BACK).
  - On the screen that appears, you can confirm whether or not there is backup data in the storage area.
2. Press **[F2]** (LOAD).
  - A message appears to confirm whether or not you really want to restore the backed up data.

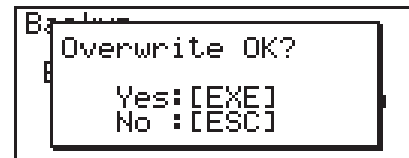

Press **[EXE]** (Yes) to restore the data and delete any data currently in the current area.

Press **[ESC]** (No) to cancel the data backup operation.

The message "Complete!" appears when the restore operation is finished.

Press **[ESC]** to return to the screen displayed in step 1.

---

### • To delete backup data from the storage area

1. On the initial MEMORY Mode screen press **[F2]** (BACK).
  - On the screen that appears, you can confirm whether or not there is backup data in the storage area.
2. Press **[F3]** (DEL).
  - A message appears to confirm whether or not you really want to delete the backed up data.

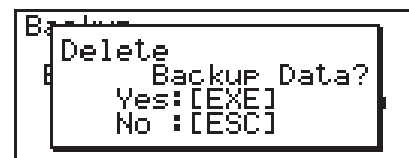

Press **[EXE]** (Yes) to delete the backed up data from the storage area.

Press **[ESC]** (No) to cancel the backup data delete operation.

The message "Complete!" appears when the delete operation is complete.

Press **[ESC]** to return to the screen displayed in step 1, which now contains the message "No Backup Data."



---

## ■ Optimizing the Storage Area

Storage area memory can become fragmented after many store and load operations. Fragmentation can cause blocks of memory to become unavailable for data storage. Because of this, you should periodically perform the storage area optimization procedure, which rearranges the data in the storage area and makes memory usage more economical.

---

### • To optimize the storage area

On the initial MEMORY Mode screen press **F3**(OPT) to start storage area optimization.

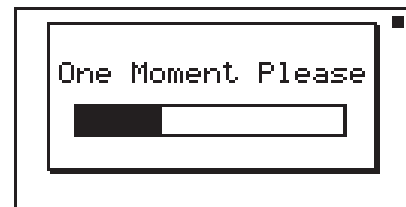

The message "Complete!" appears when the optimize operation is complete.

Press **ESC** to return to the initial MEMORY Mode screen.



# Appendix

- 1 Error Message Table
- 2 Input Ranges
- 3 Specifications
- 4 Index
- 5 Key Index
- 6 P Button (In case of hang up)
- 7 Power Supply



# 1 Error Message Table

| Message       | Meaning                                                                                                                                                                                                                                                                                                                                                                                                            | Countermeasure                                                                                                                                                                                                                                                                                                                                        |
|---------------|--------------------------------------------------------------------------------------------------------------------------------------------------------------------------------------------------------------------------------------------------------------------------------------------------------------------------------------------------------------------------------------------------------------------|-------------------------------------------------------------------------------------------------------------------------------------------------------------------------------------------------------------------------------------------------------------------------------------------------------------------------------------------------------|
| Syntax ERROR  | <ul style="list-style-type: none"> <li>Illegal syntax</li> <li>Attempt to input an illegal command</li> </ul>                                                                                                                                                                                                                                                                                                      | <ul style="list-style-type: none"> <li>Press <b>ESC</b> to display the error and make necessary corrections.</li> </ul>                                                                                                                                                                                                                               |
| Ma ERROR      | <ul style="list-style-type: none"> <li>Calculation result exceeds the display range.</li> <li>Calculation is outside the input range of a function.</li> <li>Mathematical error (division by zero, etc.)</li> <li>Sufficient precision could not be obtained for <math>\Sigma</math> calculation, differential calculation, etc.</li> <li>Solution could not be obtained for equation calculation, etc.</li> </ul> | <ul style="list-style-type: none"> <li>Check input values and make corrections to ensure that values are within allowable limits.</li> </ul>                                                                                                                                                                                                          |
| Go ERROR      | <ol style="list-style-type: none"> <li>No corresponding Lbl <math>n</math> for Goto <math>n</math>.</li> <li>No program stored in program area Prog "file name".</li> </ol>                                                                                                                                                                                                                                        | <ol style="list-style-type: none"> <li>Correctly input a Lbl <math>n</math> to correspond to the Goto <math>n</math>, or delete the Goto <math>n</math> if not required.</li> <li>Store a program in program area Prog "file name", or delete the Prog "file name" if not required.</li> </ol>                                                        |
| Nesting ERROR | <ul style="list-style-type: none"> <li>Nesting of subroutines by Prog "file name" exceeds 10 levels.</li> </ul>                                                                                                                                                                                                                                                                                                    | <ul style="list-style-type: none"> <li>Ensure that Prog "file name" is not used to return from subroutines to main routine. If used, delete any unnecessary Prog "file name".</li> <li>Trace the subroutine jump destinations and ensure that no jumps are made back to the original program area. Ensure that returns are made correctly.</li> </ul> |
| Stack ERROR   | <ul style="list-style-type: none"> <li>Execution of calculations that exceed the capacity of the stack for numeric values or stack for commands.</li> </ul>                                                                                                                                                                                                                                                        | <ul style="list-style-type: none"> <li>Simplify the formulas to keep stacks within 10 levels for the numeric values and 26 levels for the commands.</li> <li>Divide the formula into two or more parts.</li> </ul>                                                                                                                                    |



$\alpha$ -1-2  
Error Message Table

| Message         | Meaning                                                                                                                                                                                                                                                                                                                                                                                   | Countermeasure                                                                                                                                                                                                                                                                                                                        |
|-----------------|-------------------------------------------------------------------------------------------------------------------------------------------------------------------------------------------------------------------------------------------------------------------------------------------------------------------------------------------------------------------------------------------|---------------------------------------------------------------------------------------------------------------------------------------------------------------------------------------------------------------------------------------------------------------------------------------------------------------------------------------|
| Memory ERROR    | <ul style="list-style-type: none"> <li>Operation or memory storage operation exceeds remaining memory capacity.</li> </ul>                                                                                                                                                                                                                                                                | <ul style="list-style-type: none"> <li>Keep the number of variables you use for the operation within the number of variables currently available.</li> <li>Simplify the data you are trying to store to keep it within the available memory capacity.</li> <li>Delete no longer needed data to make room for the new data.</li> </ul> |
| Argument ERROR  | <ul style="list-style-type: none"> <li>Incorrect argument specification for a command that requires an argument.</li> </ul>                                                                                                                                                                                                                                                               | <ul style="list-style-type: none"> <li>Correct the argument.</li> </ul>                                                                                                                                                                                                                                                               |
| Dimension ERROR | <ul style="list-style-type: none"> <li>Illegal dimension or list used during matrix calculations.</li> </ul>                                                                                                                                                                                                                                                                              | <ul style="list-style-type: none"> <li>Check the matrix or list dimension.</li> </ul>                                                                                                                                                                                                                                                 |
| Range ERROR     | <ol style="list-style-type: none"> <li>Input of an improper V-Window value.</li> <li>V-Window range settings exceeded when a graph is redrawn.</li> <li>Input of an improper value on the range screen and use of that value for execution.</li> </ol>                                                                                                                                    | <ol style="list-style-type: none"> <li>Change the V-Window value so it is within range.</li> <li>Redraw using the proper settings.</li> <li>Input a proper range value.</li> </ol>                                                                                                                                                    |
| Condition ERROR | <ul style="list-style-type: none"> <li>Execution of a calculation or function before all conditions required for execution are met.</li> </ul>                                                                                                                                                                                                                                            | <ul style="list-style-type: none"> <li>Check the conditions and make any necessary corrections.</li> </ul>                                                                                                                                                                                                                            |
| Non-Real ERROR  | <ol style="list-style-type: none"> <li>Calculation that produces a complex number when Real is specified for the Complex Mode setting on the SET UP screen, even though the argument is a real number.</li> <li>Calculation that produces a complex number when Real is specified for the Answer Type setting on the SET UP screen, even though the argument is a real number.</li> </ol> | <ol style="list-style-type: none"> <li>Change the Complex Mode setting to something other than Real.</li> <li>Change the Answer Type setting to something other than Real.</li> </ol>                                                                                                                                                 |



$\alpha$ -1-3  
Error Message Table

| Message                                                        | Meaning                                                                                                                                                                                                         | Countermeasure                                                                                                                                                                          |
|----------------------------------------------------------------|-----------------------------------------------------------------------------------------------------------------------------------------------------------------------------------------------------------------|-----------------------------------------------------------------------------------------------------------------------------------------------------------------------------------------|
| Complex Number In List                                         | <ul style="list-style-type: none"> <li>Use of a list that contains complex numbers in a real number calculation.</li> </ul>                                                                                     | <ul style="list-style-type: none"> <li>Change all data in the list to real numbers.</li> </ul>                                                                                          |
| Complex Number In Matrix                                       | <ul style="list-style-type: none"> <li>Use of a matrix that contains complex numbers in a real number calculation.</li> </ul>                                                                                   | <ul style="list-style-type: none"> <li>Change all data in the matrix to real numbers.</li> </ul>                                                                                        |
| Can't Solve!<br>Adjust Initial Value Or Bounds. Then Try Again | <ul style="list-style-type: none"> <li>Solve could not obtain a solution within the specified range.</li> </ul>                                                                                                 | <ul style="list-style-type: none"> <li>Change the specified range.</li> <li>Correct the input expression.</li> </ul>                                                                    |
| No Variable                                                    | <ul style="list-style-type: none"> <li>No variable specified within a graph function being used for Dynamic Graph.</li> <li>No variable within a Solve equation.</li> </ul>                                     | <ul style="list-style-type: none"> <li>Specify a variable for the graph function.</li> </ul>                                                                                            |
| Iteration ERROR                                                | <ol style="list-style-type: none"> <li>No convergence of Solve solutions.</li> <li>No integration or differential calculation solution that satisfies operation ending condition (<i>tol</i> value).</li> </ol> | <ol style="list-style-type: none"> <li>Change the initial estimated value to one that is nearer to the solution.</li> <li>Increase the <i>tol</i> value to reduce precision.</li> </ol> |
| Com ERROR                                                      | <ul style="list-style-type: none"> <li>Problem with cable connection or parameter setting during program data communications.</li> </ul>                                                                        | <ul style="list-style-type: none"> <li>Check the cable connection.</li> </ul>                                                                                                           |
| Transmit ERROR                                                 | <ul style="list-style-type: none"> <li>Problem with cable connection or parameter setting during data communications.</li> </ul>                                                                                | <ul style="list-style-type: none"> <li>Check the cable connection.</li> </ul>                                                                                                           |
| Receive ERROR                                                  | <ul style="list-style-type: none"> <li>Problem with cable connection or parameter setting during data communications.</li> </ul>                                                                                | <ul style="list-style-type: none"> <li>Check the cable connection.</li> </ul>                                                                                                           |
| Memory Full                                                    | <ul style="list-style-type: none"> <li>Memory of receiving unit became full during program data communications.</li> </ul>                                                                                      | <ul style="list-style-type: none"> <li>Delete some data stored in the receiving unit and try again.</li> </ul>                                                                          |





*$\alpha$ -1-4  
Error Message Table*

| <b>Message</b>    | <b>Meaning</b>                                                                                                                                           | <b>Countermeasure</b>                                                                                                       |
|-------------------|----------------------------------------------------------------------------------------------------------------------------------------------------------|-----------------------------------------------------------------------------------------------------------------------------|
| Download<br>ERROR | <ul style="list-style-type: none"><li>• Data communication cable disconnect during add-in installation, or incorrect data transfer conditions.</li></ul> | <ul style="list-style-type: none"><li>• Press <b>EXE</b> and try again.</li><li>• Press <b>ESC</b> and try again.</li></ul> |
| Model<br>Mismatch | <ul style="list-style-type: none"><li>• Attempt to perform back up between two different models.</li></ul>                                               | <ul style="list-style-type: none"><li>• Use two identical models.</li></ul>                                                 |
| Overflow<br>ERROR | <ul style="list-style-type: none"><li>• Overflow of the calculation range in the Algebre Mode.</li></ul>                                                 | <ul style="list-style-type: none"><li>• Correct the input expression.</li></ul>                                             |
| Domain<br>ERROR   | <ul style="list-style-type: none"><li>• Overflow of the input element range in the Algebre Mode.</li></ul>                                               | <ul style="list-style-type: none"><li>• Correct the input expression.</li></ul>                                             |



## 2 Input Ranges

| Function                         | Input range for real number solutions                                                                                           | Internal digits | Precision                                          | Notes                                                                                                                                                          |
|----------------------------------|---------------------------------------------------------------------------------------------------------------------------------|-----------------|----------------------------------------------------|----------------------------------------------------------------------------------------------------------------------------------------------------------------|
| $\sin x$<br>$\cos x$<br>$\tan x$ | (DEG) $ x  < 9 \times (10^9)^\circ$<br>(RAD) $ x  < 5 \times 10^7 \pi \text{rad}$<br>(GRA) $ x  < 1 \times 10^{10} \text{grad}$ | 15 digits       | As a rule, precision is $\pm 1$ at the 10th digit. | However, for $\tan x$ :<br>$ x  \neq 90(2n+1)$ :DEG<br>$ x  \neq \pi/2(2n+1)$ :RAD<br>$ x  \neq 100(2n+1)$ :GRA<br>* Complex numbers can be used as arguments. |
| $\sin^{-1}x$<br>$\cos^{-1}x$     | $ x  \leq 1$                                                                                                                    | "               | "                                                  | * Complex numbers can be used as arguments.                                                                                                                    |
| $\tan^{-1}x$                     | $ x  < 1 \times 10^{100}$                                                                                                       |                 |                                                    |                                                                                                                                                                |
| $\sinh x$<br>$\cosh x$           | $ x  \leq 230.2585092$                                                                                                          | "               | "                                                  | For $\sinh$ and $\tanh$ , when $x = 0$ , errors are cumulative and precision is affected at a certain point.<br>* Complex numbers can be used as arguments.    |
| $\tanh x$                        | $ x  < 1 \times 10^{100}$                                                                                                       |                 |                                                    |                                                                                                                                                                |
| $\sinh^{-1}x$<br>$\cosh^{-1}x$   | $ x  < 5 \times 10^{99}$<br>$1 \leq x < 5 \times 10^{99}$                                                                       | "               | "                                                  | * Complex numbers can be used as arguments.                                                                                                                    |
| $\tanh^{-1}x$                    | $ x  < 1$                                                                                                                       |                 |                                                    |                                                                                                                                                                |
| $\log x$<br>$\ln x$              | $1 \times 10^{-99} \leq x < 1 \times 10^{100}$                                                                                  | "               | "                                                  | * Complex numbers can be used as arguments.                                                                                                                    |
| $10^x$<br>$e^x$                  | $-1 \times 10^{100} < x < 100$<br>$-1 \times 10^{100} < x \leq 230.2585092$                                                     | "               | "                                                  | * Complex numbers can be used as arguments.                                                                                                                    |
| $\sqrt{x}$<br>$x^2$              | $0 \leq x < 1 \times 10^{100}$<br>$ x  < 1 \times 10^{50}$                                                                      | "               | "                                                  | * Complex numbers can be used as arguments.                                                                                                                    |
| $1/x$<br>$\sqrt[3]{x}$           | $ x  < 1 \times 10^{100}, x \neq 0$<br>$ x  < 1 \times 10^{100}$                                                                | "               | "                                                  | * Complex numbers can be used as arguments.                                                                                                                    |
| $x!$                             | $0 \leq x \leq 69$<br>(x is an integer)                                                                                         | "               | "                                                  |                                                                                                                                                                |
| $nPr$<br>$nCr$                   | Result $< 1 \times 10^{100}$<br>$n, r$ (n and r are integers)<br>$0 \leq r \leq n,$<br>$n < 1 \times 10^{10}$                   | "               | "                                                  |                                                                                                                                                                |



α-2-2  
Input Ranges

| Function           | Input range for real number solutions                                                                                                                                                                                                          | Internal digits | Precision                                          | Notes                                                                                                                               |
|--------------------|------------------------------------------------------------------------------------------------------------------------------------------------------------------------------------------------------------------------------------------------|-----------------|----------------------------------------------------|-------------------------------------------------------------------------------------------------------------------------------------|
| Pol (x, y)         | $\sqrt{x^2 + y^2} < 1 \times 10^{100}$                                                                                                                                                                                                         | 15 digits       | As a rule, precision is $\pm 1$ at the 10th digit. |                                                                                                                                     |
| Rec (r, $\theta$ ) | $ r  < 1 \times 10^{100}$<br>(DEG) $ \theta  < 9 \times (10^9)^\circ$<br>(RAD) $ \theta  < 5 \times 10^7 \pi$ rad<br>(GRA) $ \theta  < 1 \times 10^{10}$ grad                                                                                  | "               | "                                                  | However, for $\tan \theta$ :<br>$ \theta  \neq 90(2n+1)$ :DEG<br>$ \theta  \neq \pi/2(2n+1)$ :RAD<br>$ \theta  \neq 100(2n+1)$ :GRA |
| ◦, ,,              | $ a , b, c < 1 \times 10^{100}$<br>$0 \leq b, c$                                                                                                                                                                                               | "               | "                                                  |                                                                                                                                     |
| ←<br>◦, ,,         | $ x  < 1 \times 10^{100}$<br>Sexagesimal display:<br>$ x  < 1 \times 10^7$                                                                                                                                                                     |                 |                                                    |                                                                                                                                     |
| $^{(x^y)}$         | $x > 0$ :<br>$-1 \times 10^{100} < y \log x < 100$<br>$x = 0 : y > 0$<br>$x < 0$ :<br>$y = n, \frac{1}{2n+1}$ (n is an integer or a fraction)<br>However;<br>$-1 \times 10^{100} < \frac{1}{y} \log  x  < 100$                                 | "               | "                                                  | * Complex numbers can be used as arguments.                                                                                         |
| $^x \sqrt{y}$      | $y > 0 : x \neq 0$<br>$-1 \times 10^{100} < \frac{1}{x} \log y < 100$<br>$y = 0 : x > 0$<br>$y < 0 : x = 2n + 1, \frac{1}{n}$<br>( $n \neq 0, n$ is an integer or a fraction)<br>However;<br>$-1 \times 10^{100} < \frac{1}{x} \log  y  < 100$ | "               | "                                                  | * Complex numbers can be used as arguments.                                                                                         |
| $a^{b/c}$          | Total of integer, numerator and denominator must be within 10 digits (includes division marks).                                                                                                                                                | "               | "                                                  |                                                                                                                                     |

\* Errors may be cumulative and precision may be affected by  $^{(x^y)}$ ,  $^x \sqrt{y}$ ,  $x^y$ ,  $^3 \sqrt{x}$  and other functions that require internal continuous calculations, and by calculations involving complex numbers.



*α-2-3*  
*Input Ranges*

| <b>Function</b>                                             | <b>Input range</b>                                                                                                                                                                                                                                                                                                                                                                                                              |
|-------------------------------------------------------------|---------------------------------------------------------------------------------------------------------------------------------------------------------------------------------------------------------------------------------------------------------------------------------------------------------------------------------------------------------------------------------------------------------------------------------|
| Binary,<br>octal,<br>decimal,<br>hexadecimal<br>calculation | Values fall within following ranges after conversion:<br>DEC: $-2147483648 \leq x \leq 2147483647$<br>BIN: $1000000000000000 \leq x$<br>$\leq 1111111111111111$ (negative)<br>$0 \leq x \leq 0111111111111111$ (0, positive)<br>OCT: $20000000000 \leq x \leq 37777777777$ (negative)<br>$0 \leq x \leq 17777777777$ (0, positive)<br>HEX: $80000000 \leq x \leq FFFFFFFF$ (negative)<br>$0 \leq x \leq 7FFFFFFF$ (0, positive) |



## 3 Specifications

---

**Variables:** 28

**Calculation range:**

$\pm 1 \times 10^{-99}$  to  $\pm 9.999999999 \times 10^{99}$  and 0. Internal operations use 15-digit mantissa.

**Exponential display range:** Norm 1:  $10^{-2} > |x|$ ,  $|x| \geq 10^{10}$

Norm 2:  $10^{-9} > |x|$ ,  $|x| \geq 10^{10}$

**Program capacity:** 144 kbytes (max.)

**Power supply:**

**Main:** Four AAA-size batteries (LR03 (AM4) or R03 (UM-4))

**Back-up:** One CR2032 lithium battery

**Power consumption:** 0.2 W

**Approximate battery life**

**Main:**

LR03 (AM4): 230 hours (continuous display of main menu)

150 hours continuous operation (5 minutes calculation, 55 minutes display)

R03 (UM-4): 140 hours (continuous display of main menu)

90 hours continuous operation (5 minutes calculation, 55 minutes display)

**Back-up:** 2 years

**Auto power off:**

Power is automatically turned off approximately six minutes or 60 minutes after last operation.

**Ambient temperature range:** 0 °C to 40 °C

**Dimensions:** 19.5 mm (H) × 82 mm (W) × 178 mm (D)

$\frac{3}{4}$ " (H) × 3  $\frac{1}{4}$ " (W) × 6  $\frac{7}{8}$ " (D)

**Weight:** Approx. 213 g (including batteries)



**Data Communications**

**Method:** Start-stop (asynchronous), half-duplex

**Transmission speed (BPS):** 38400 bits/second (normal)  
9600 bits/second (H-Copy & Send/Receive)

**Parity:** None

**Bit length:** 8 bits

**Stop bit:**

Send: 3 bits

Receive: 2 bits

Includes parity (None) 1-bit

**X ON/X OFF Control:** None



## 4 Index

### Symbols

- $\Delta$ List ..... 3-2-7
- $\Sigma$  calculation ..... 2-5-10

### A

- Absolute value ..... 2-6-2
- Add-ins ..... 10-7-1
- Algebra Mode ..... 7-2-1
- Algebra Mode operation ..... 7-1-2
- Angle unit ..... 2-3-1, 2-4-2
- Ans ..... 2-2-5
- Answer function ..... 2-2-5
- Answer memory ..... 2-2-5, 7-1-5
- APO settings ..... 9-3-1
- Argument ..... 2-6-2
- Arithmetic calculations ..... 2-1-1
- Asymptotes ..... 5-11-21
- Auto Mode ..... 7-3-8
- Auto power off ..... 9-3-1,  $\alpha$ -7-5
- Axis of symmetry ..... 5-11-20

### B

- Backing up data ..... 10-8-7
- Backup data, sending ..... 10-4-4
- Bar graph ..... 6-2-1
- Binary calculation ..... 2-7-1
- Box zoom ..... 5-2-7

### C

- Calc window ..... 5-2-12
- Calculation execution indicator ..... 1-2-5
- Calculation priority sequence ..... 2-1-3

- Calculation results of a paired-variable graph ..... 6-3-11, 6-4-2
- Calculation results of a single-variable graph ..... 6-2-4, 6-4-2
- CAS Mode ..... 7-1-1
- Catalog ..... 1-3-5
- Cell, editing ..... 3-1-3
- Center ..... 5-11-19
- Circle ..... 5-1-5
- Clipboard ..... 1-3-4
- Column operations ..... 2-8-9
- Combination ..... 2-4-9
- Comments ..... 5-10-3
- Complex number calculations ..... 2-6-1
- CONICS Mode ..... 5-1-5
- Conjugate complex number ..... 2-6-3
- Connecting the unit to a personal computer ..... 10-3-1
- Connecting the unit with a CASIO Label Printer ..... 10-2-1
- Connecting two units ..... 10-1-1
- Continuous calculations ..... 2-2-5, 7-1-5
- Contrast adjustment ..... 9-3-1
- Coordinate conversion ..... 2-4-2, 2-4-8
- Coordinate rounding ..... 5-11-7
- Coordinates for given points ..... 5-11-13
- Coordinates on a graph line ..... 5-11-1
- Copy range ..... 1-3-4
- Copying a regression graph formula ..... 6-3-11
- Copying a table column to a list ..... 5-7-8
- Corrections ..... 1-3-4
- Cubic regression graph ..... 6-3-7
- Current area ..... 10-8-1



## D

- Data communication operation ..... 10-4-1
- DATA ERROR message .....  $\alpha$ -6-1
- Debugging ..... 8-3-1
- Decimal calculations ..... 2-7-1
- Decimal places ..... 2-1-2, 2-3-1
- Degrees/minutes/seconds ..... 1-2-5, 2-4-2
- Derivative item ..... 5-7-3, 5-11-3
- Determinant ..... 2-8-18
- Differential calculations ..... 2-5-2
- Directrix ..... 5-11-20
- Display format ..... 2-3-1
- Display screens ..... 1-2-3
- Draw/non draw status of a graph ..... 5-3-4
- Drawing a line ..... 5-10-1
- Dual graph ..... 5-5-1
- DYNA Mode ..... 5-8-1
- Dynamic graph ..... 5-8-1
- Dynamic graph functions in a program  
..... 8-6-5
- Dynamic graph memory ..... 5-8-6

## E

- Eccentricity ..... 5-11-21
- Editing calculations ..... 1-3-1
- Ellipse ..... 5-1-5
- Eng ..... 2-3-2, 2-4-11
- Eqn memory ..... 7-1-4
- EQUA Mode ..... 4-1-1
- Error message ..... 2-1-5,  $\alpha$ -1-1
- Estimated value ..... 6-4-4
- Exponential function ..... 2-4-4
- Exponential regression graph ..... 6-3-8

## F

- Factor zoom ..... 5-2-9

- File name, editing ..... 8-4-2
- File name, registering ..... 8-1-1, 8-1-2
- Flash memory ..... 10-8-1
- FMEM ..... 2-2-2
- Focus ..... 5-11-18
- Formula memory ..... 7-1-3
- Formula number area ..... 7-1-1
- Fraction ..... 1-2-5, 2-4-10
- Freehand drawing ..... 5-10-5
- Function analysis ..... 5-11-1
- Function memory ..... 2-2-2
- Function menu ..... 1-2-3, 5-2-11
- Function, edit/change/delete ..... 5-3-3

## G

- Generating a table ..... 5-7-2
- Graph background ..... 5-10-7
- Graph function, recall ..... 5-3-5
- Graph functions in a program ..... 8-6-3
- Graph functions, store ..... 5-3-5
- Graph memory ..... 5-3-5, 7-1-4
- Graph parameters, changing ..... 6-1-2
- Graph screen ..... 1-2-3
- Graph to table ..... 5-11-5
- Graph type, specifying ..... 5-3-1
- Graph, store/recall ..... 5-4-1
- Graph-Table linking ..... 5-7-15
- GRPH•TBL Mode ..... 5-1-1

## H

- Hexadecimal calculation ..... 1-2-5, 2-7-1
- High degree equations ..... 4-2-1
- Histogram ..... 6-2-1
- Hyperbola ..... 5-1-5
- Hyperbolic function (HYP) ..... 2-4-2, 2-4-5





## I

|                                       |               |
|---------------------------------------|---------------|
| Icon .....                            | 1-2-1         |
| Imaginary part .....                  | 2-6-3         |
| Implicit function .....               | 5-11-17       |
| Inequality .....                      | 5-3-2         |
| Input area .....                      | 7-1-1         |
| Input ranges .....                    | $\alpha$ -2-1 |
| Inputting calculations .....          | 1-3-1         |
| Integral value for a given range .... | 5-11-15       |
| Integration calculation .....         | 2-5-7         |
| Integration graph .....               | 5-6-3         |
| Intercepts .....                      | 5-11-19       |
| Inverse hyperbolic function .....     | 2-4-2, 2-4-5  |
| Inverse trigonometric function .....  | 2-4-3         |

## K

|                    |       |
|--------------------|-------|
| Key markings ..... | 1-1-3 |
| Key table .....    | 1-1-2 |

## L

|                                        |         |
|----------------------------------------|---------|
| Latus rectum .....                     | 5-11-18 |
| Line graph .....                       | 6-2-3   |
| Linear equation .....                  | 7-3-2   |
| Linear inequality .....                | 7-3-2   |
| Linear regression graph .....          | 6-3-6   |
| LINK Mode .....                        | 10-4-1  |
| List data, manipulating .....          | 3-2-1   |
| List files, switching .....            | 3-4-1   |
| List sort functions in a program ..... | 8-6-8   |
| List, arithmetic calculations .....    | 3-3-1   |
| List, inputting and editing .....      | 3-1-1   |
| Logarithmic function .....             | 2-4-4   |
| Logarithmic regression graph .....     | 6-3-8   |
| Logical operation .....                | 2-7-4   |
| Logistic regression graph .....        | 6-3-10  |

|                           |                      |
|---------------------------|----------------------|
| Low battery message ..... | 1-8-2, $\alpha$ -7-1 |
|---------------------------|----------------------|

## M

|                                            |                |
|--------------------------------------------|----------------|
| Main screen .....                          | 5-5-1          |
| Manual graphing .....                      | 5-6-1          |
| Manual Mode .....                          | 7-3-6          |
| MatAns .....                               | 2-8-1          |
| Matrices using matrix commands<br>.....    | 2-8-10, 2-8-13 |
| Matrix arithmetic operation .....          | 2-8-17         |
| Matrix inversion .....                     | 2-8-19         |
| Matrix row operations in a program ..      | 8-6-1          |
| Matrix transposition .....                 | 2-8-18         |
| Matrix, dimension .....                    | 2-8-2, 2-8-12  |
| Matrix, inputting and editing .....        | 2-8-2          |
| Maximum/minimum value calculation<br>..... | 2-5-12         |
| Med-box graph .....                        | 6-2-2          |
| Med-Med graph .....                        | 6-3-6          |
| Memory .....                               | 2-2-1          |
| Memory capacity .....                      | 2-1-6          |
| Memory Mode .....                          | 10-8-1         |
| Memory operations .....                    | 9-2-1          |
| Menu bar command .....                     | 1-2-3          |
| Mode set up .....                          | 1-7-1          |
| Modified box graph .....                   | 6-2-2          |
| Multi-Replay .....                         | 1-3-3          |
| Multiple graphs .....                      | 6-3-12         |
| Multiplication sign .....                  | 2-1-5          |
| Multistatements .....                      | 2-2-7          |

## N

|                                   |                     |
|-----------------------------------|---------------------|
| Natural result display area ..... | 7-1-1               |
| Negative value .....              | 2-7-4               |
| Norm 1/2 mode .....               | 1-2-4, 2-3-2        |
| Normal display .....              | 1-2-4, 2-1-2, 2-3-2 |



Normal distribution curve ..... 6-2-3  
Normal probability plot ..... 6-2-1  
Number system ..... 2-7-3  
Number system transformation ..... 2-7-5  
Numeric calculations (NUM) ..... 2-4-1

## O

Octal calculations ..... 2-7-1  
Optimizing the storage area ..... 10-8-9  
Option (OPTN) menu ..... 1-4-1  
Output area ..... 7-1-1  
Overflow ..... 2-1-5  
Overwrite the graphs ..... 5-6-5

## P

P button .....  $\alpha$ -6-1  
Paired-variable statistical graph ..... 6-3-1  
Parabola ..... 5-1-5  
Parametric function ..... 5-3-2  
Parentheses ..... 2-1-1  
Password ..... 8-4-3  
Pasting text ..... 1-3-5  
Permutation ..... 2-4-9  
Picture memory ..... 5-4-1  
Plot ..... 5-1-4  
Point of intersection of two graphs  
..... 5-11-11  
Polar coordinate function ..... 5-3-1  
Polar form transformation ..... 2-6-4  
POLY ..... 4-2-1  
Power regression graph ..... 6-3-9  
Power supply .....  $\alpha$ -7-1  
PRGM Mode ..... 8-1-1  
Probability distribution graph ..... 6-4-7  
Probability/distribution calculations  
(PROB) ..... 2-4-1, 6-4-5

Program (PRGM) menu ..... 1-6-1  
Program file, load ..... 10-8-3  
Program file, searching ..... 8-4-1, 10-8-5  
Program file, store ..... 10-8-2  
Program files, deleting ..... 10-8-4  
Program library ..... 8-8-1  
Program mode command ..... 8-7-1  
Program, BASE Mode ..... 8-2-2  
Program, deleting ..... 8-4-2  
Program, editing ..... 8-3-1  
Program, inputting ..... 8-2-1  
Program, running ..... 8-1-1  
Program, searching for data ..... 8-3-4  
Pull-up menu ..... 1-2-3

## Q

Quadratic differential calculation ..... 2-5-5  
Quadratic equation ..... 7-3-2  
Quadratic regression graph ..... 6-3-7  
Quartic regression graph ..... 6-3-7

## R

Radius ..... 5-11-19  
Raising a matrix to a power ..... 2-8-20  
Random number ..... 2-4-7  
Real part ..... 2-6-3  
Rectangular coordinate function ..... 5-3-1  
Rectangular transformation ..... 2-6-4  
RECUR Mode ..... 5-9-1  
Recursion formula number table ..... 5-9-1  
Recursion Table & Graph functions in a  
program ..... 8-6-7  
Regression calculation ..... 6-4-3  
Regression graph ..... 6-3-3  
Replay ..... 1-3-3, 7-1-5  
Reset ..... 9-4-1



Residual calculation ..... 6-3-10  
Root ..... 5-11-9  
Row calculations ..... 2-8-5  
RUN•MAT Mode ..... 2-1-1

## **S**

Scalar product ..... 2-8-17  
Scatter diagram ..... 6-3-1  
Screen shot, saving ..... 10-6-1  
Screen shot, sending ..... 10-6-1  
Set up screen ..... 1-7-1  
Sexagesimal operations ..... 1-2-5, 2-4-2  
Significant digits ..... 2-1-2, 2-3-2  
SIML ..... 4-1-1  
Simultaneous linear equations  
..... 4-1-1, 7-3-1  
Single-variable statistical graph ..... 6-2-1  
Sinusoidal regression graph ..... 6-3-9  
Sketch ..... 5-10-1  
Solve calculation ..... 2-5-1, 4-3-1  
Solve calculation function in a program  
..... 8-6-9  
Solve Mode ..... 7-3-4  
Sorting list values ..... 3-1-5  
Squaring a matrix ..... 2-8-19  
Stacks ..... 2-2-6  
STAT Mode ..... 6-1-1  
Statistical calculation data lists ..... 6-4-1  
Statistical calculations and graphs in a  
program ..... 8-6-9  
Statistical data list ..... 6-1-1  
Storage area ..... 10-8-1  
Sub-screen ..... 5-5-1  
Submenu ..... 1-2-3  
System language setting ..... 9-3-2  
SYSTEM Mode ..... 9-1-1  
System setting menu ..... 9-1-1

## **T**

Table & Graph functions in a program  
..... 8-6-6  
Table range ..... 5-7-1  
Table, deleting ..... 5-7-7  
Tables ..... 5-7-1  
Tables, editing ..... 5-7-5  
Text display ..... 8-6-1  
Text screen ..... 1-2-3  
Trace ..... 5-11-1  
Trigonometric function ..... 2-4-3  
TUTOR ..... 7-3-1  
Tutorial lock ..... 9-5-1  
Tutorial Mode ..... 7-3-1

## **V**

V-Window ..... 5-2-1  
V-Window memory ..... 5-2-4  
Variable ..... 2-2-1  
Variable data (VARS) menu ..... 1-5-1  
Verify Mode ..... 7-3-4  
Vertex ..... 5-11-18

## **W**

WEB graph ..... 5-9-7

## **X**

X = constant expression ..... 5-3-2  
xy line graph ..... 6-3-1

## **Z**

Zoom ..... 5-2-7



## CAS, ALGEBRA, TUTOR Command Index

|                   |        |                  |        |
|-------------------|--------|------------------|--------|
| absExpand .....   | 7-2-2  | getRight .....   | 7-1-16 |
| andConnect .....  | 7-3-7  | lim .....        | 7-1-12 |
| approx .....      | 7-1-11 | numerator .....  | 7-1-14 |
| arcLen .....      | 7-1-13 | rclAllEqn .....  | 7-1-15 |
| arrange .....     | 7-2-1  | rclEqn .....     | 7-1-15 |
| cExpand .....     | 7-1-10 | replace .....    | 7-2-1  |
| clear .....       | 7-1-17 | rewrite .....    | 7-1-15 |
| clearVarAll ..... | 7-1-17 | rFactor .....    | 7-1-7  |
| collect .....     | 7-1-10 | simplify .....   | 7-1-9  |
| combine .....     | 7-1-10 | solve .....      | 7-1-8  |
| denominator ..... | 7-1-14 | substitute ..... | 7-1-10 |
| diff .....        | 7-1-12 | tanLine .....    | 7-1-14 |
| eliminate .....   | 7-1-16 | taylor .....     | 7-1-13 |
| eqn .....         | 7-1-16 | tCollect .....   | 7-1-8  |
| exchange .....    | 7-1-15 | tExpand .....    | 7-1-8  |
| expand .....      | 7-1-7  | trigToExp .....  | 7-1-9  |
| expToTrig .....   | 7-1-9  | $\int$ .....     | 7-1-12 |
| factor .....      | 7-1-7  | $\Sigma$ .....   | 7-1-13 |
| gcd .....         | 7-1-14 | $\Pi$ .....      | 7-1-13 |























## PRGM Command Index

|                                |        |                                                  |        |
|--------------------------------|--------|--------------------------------------------------|--------|
| Break .....                    | 8-5-6  | Goto~Lbl .....                                   | 8-5-10 |
| ClrGraph .....                 | 8-5-11 | If~Then~(Else~)IfEnd .....                       | 8-5-4  |
| ClrList .....                  | 8-5-11 | Isz .....                                        | 8-5-11 |
| ClrMat .....                   | 8-5-12 | Locate .....                                     | 8-5-16 |
| ClrText .....                  | 8-5-12 | Prog .....                                       | 8-5-7  |
| DispF-Tbl, DispR-Tbl .....     | 8-5-12 | Receive ( /Send ( .....                          | 8-5-17 |
| Do~LpWhile .....               | 8-5-5  | Return .....                                     | 8-5-8  |
| DrawDyna .....                 | 8-5-12 | Stop .....                                       | 8-5-8  |
| DrawFTG-Con, DrawFTG-Plt ..... | 8-5-13 | While~WhileEnd .....                             | 8-5-6  |
| DrawGraph .....                | 8-5-13 | ? (Input Command) .....                          | 8-5-2  |
| DrawR-Con, DrawR-Plt .....     | 8-5-13 | ▲ (Output Command) .....                         | 8-5-3  |
| DrawRΣ-Con, DrawRΣ-Plt .....   | 8-5-14 | : (Multi-statement Command) .....                | 8-5-3  |
| DrawStat .....                 | 8-5-14 | ↵ (Carriage Return) .....                        | 8-5-3  |
| DrawWeb .....                  | 8-5-14 | ' (Comment Text Delimiter) .....                 | 8-5-3  |
| Dsz .....                      | 8-5-9  | =, ≠, >, <, ≥, ≤<br>(Relational Operators) ..... | 8-5-18 |
| For~To~(Step~)Next .....       | 8-5-4  |                                                  |        |
| Getkey .....                   | 8-5-15 |                                                  |        |

























## 5 Key Index





















| Key                                                                                          | Primary Function                | Combined with  | Combined with  |
|----------------------------------------------------------------------------------------------|---------------------------------|---------------------------------------------------------------------------------------------------|---------------------------------------------------------------------------------------------------|
| COPY<br>    | Selects 1st function menu item. | Performs copy operation.                                                                          |                                                                                                   |
| PASTE<br>   | Selects 2nd function menu item. | Performs paste operation.                                                                         |                                                                                                   |
| SET UP<br>  | Selects 3rd function menu item. | Shows the set up display.                                                                         |                                                                                                   |
| CAT/CAL<br> | Selects 4th function menu item. | Shows the Catalog or opens the Calc Window.                                                       |                                                                                                   |
| G ↔ T<br>   | Selects 5th function menu item. | Switches display between graph and text screens.                                                  |                                                                                                   |
| H-COPY<br>  | Selects 6th function menu item. | Sends a shot of the current screen to a connected device.                                         |                                                                                                   |
|             | Enters number 0.                | Toggles function menu display on and off.                                                         |                                                                                                   |

| Key                                                                                                                                                                        | Primary Function                                                 | Combined with  | Combined with  |
|----------------------------------------------------------------------------------------------------------------------------------------------------------------------------|------------------------------------------------------------------|-----------------------------------------------------------------------------------------------------|-----------------------------------------------------------------------------------------------------|
|                                                                                         | Activates shift functions of other keys and function menus.      |                                                                                                     |                                                                                                     |
|                                                                                         | Activates functions marked above function keys.                  |                                                                                                     |                                                                                                     |
| V-Window<br>                                                                            | Displays option menu.                                            | Displays View Window parameter input screen.                                                        |                                                                                                     |
|                                                                                         | Returns to the Main Menu.                                        |                                                                                                     |                                                                                                     |
| <br> | Allows entry of alphanumeric characters shown in red.            | Locks/Unlocks entry of alphanumeric characters.                                                     |                                                                                                     |
| PRGM <i>r</i><br>                                                                       | Displays the variable data menu.                                 | Displays program command menu.                                                                      | Enters character <i>r</i> .                                                                         |
| $\sqrt[\theta]{\phantom{x}}$<br>                                                        | Press between two values to make second value exponent of first. | Press between entering values for X & Y to show <i>x</i> th root of <i>y</i> .                      | Enters character <i>θ</i> .                                                                         |
| QUIT<br>                                                                                | Back steps to the previous screen without making any changes.    | Returns directly to initial screen of the mode.                                                     |                                                                                                     |



| Key                                                                                                                             | Primary Function                                                                                                                                                            | Combined with  | Combined with  |
|---------------------------------------------------------------------------------------------------------------------------------|-----------------------------------------------------------------------------------------------------------------------------------------------------------------------------|---------------------------------------------------------------------------------------------------|---------------------------------------------------------------------------------------------------|
|                                                | Moves cursor upward. Scrolls screen. Switches to previous function in trace mode.                                                                                           |                                                                                                   |                                                                                                   |
|                                                | Moves cursor downward. Scrolls screen. Switches to next function in trace mode.                                                                                             |                                                                                                   |                                                                                                   |
|                                                | Moves cursor to left. Scrolls screen. Press after  to display calculation from end.        |                                                                                                   |                                                                                                   |
|                                                | Moves cursor to right. Scrolls screen. Press after  to display calculation from beginning. |                                                                                                   |                                                                                                   |
| <sup>A</sup><br>                               | Allows input of variable X, $\theta$ , and T.                                                                                                                               |                                                                                                   | Enters letter A.                                                                                  |
| <sup>10<sup>x</sup></sup> <sup>B</sup><br>     | Press before entering value to calculate common logarithm.                                                                                                                  | Press before entering exponent value of 10.                                                       | Enters letter B.                                                                                  |
| <sup>e<sup>x</sup></sup> <sup>C</sup><br>     | Press before entering value to calculate natural logarithm.                                                                                                                 | Press before entering exponent value of e.                                                        | Enters letter C.                                                                                  |
| <sup>sin<sup>-1</sup></sup> <sup>D</sup><br> | Press before entering value to calculate sine.                                                                                                                              | Press before entering value to calculate inverse sine.                                            | Enters letter D.                                                                                  |
| <sup>cos<sup>-1</sup></sup> <sup>E</sup><br> | Press before entering value to calculate cosine.                                                                                                                            | Press before entering value to calculate inverse cosine.                                          | Enters letter E.                                                                                  |
| <sup>tan<sup>-1</sup></sup> <sup>F</sup><br> | Press before entering value to calculate tangent.                                                                                                                           | Press before entering value to calculate inverse tangent.                                         | Enters letter F.                                                                                  |
| <sup>d/c</sup> <sup>G</sup><br>              | Press between entering fraction values.<br>Converts fraction to decimal.                                                                                                    | Displays improper fractions.                                                                      | Enters letter G.                                                                                  |
| <sup>√</sup> <sup>H</sup><br>                | Press after entering value to calculate square.                                                                                                                             | Press before entering value to calculate square root.                                             | Enters letter H.                                                                                  |
| <sup>∛</sup> <sup>I</sup><br>                | Enters open parenthesis in formula.                                                                                                                                         | Press before entering value to calculate cube root.                                               | Enters letter I.                                                                                  |
| <sup>x<sup>-1</sup></sup> <sup>J</sup><br>   | Enters close parenthesis in formula.                                                                                                                                        | Press after entering value to calculate reciprocal.                                               | Enters letter J.                                                                                  |
| <sup>K</sup><br>                             | Enters comma.                                                                                                                                                               |                                                                                                   | Enters letter K.                                                                                  |
| <sup>L</sup><br>                             | Assigns value to a value memory name.                                                                                                                                       |                                                                                                   | Enters letter L.                                                                                  |
| <sup>M</sup><br>                             | Enters number 7.                                                                                                                                                            |                                                                                                   | Enters letter M.                                                                                  |
| <sup>N</sup><br>                             | Enters number 8.                                                                                                                                                            |                                                                                                   | Enters letter N.                                                                                  |



| Key                                                                                          | Primary Function                                   | Combined with  | Combined with  |
|----------------------------------------------------------------------------------------------|----------------------------------------------------|---------------------------------------------------------------------------------------------------|---------------------------------------------------------------------------------------------------|
|             | Enters number 9.                                   |                                                                                                   | Enters letter O.                                                                                  |
|             | Deletes character at current cursor location.      | Allows insertion of characters at cursor location.                                                |                                                                                                   |
|             | Turns power on.<br>Clears the display.             | Turns power off.                                                                                  |                                                                                                   |
|             | Enters number 4.                                   |                                                                                                   | Enters letter P.                                                                                  |
|             | Enters number 5.                                   |                                                                                                   | Enters letter Q.                                                                                  |
|             | Enters number 6.                                   |                                                                                                   | Enters letter R.                                                                                  |
|             | Multiplication function.                           | Enters open curly bracket.                                                                        | Enters letter S.                                                                                  |
|            | Division function.                                 | Enters close curly bracket.                                                                       | Enters letter T.                                                                                  |
| List      | Enters number 1.                                   | Inputs List command.                                                                              | Enters letter U.                                                                                  |
| Mat       | Enters number 2.                                   | Inputs Mat command.                                                                               | Enters letter V.                                                                                  |
|           | Enters number 3.                                   |                                                                                                   | Enters letter W.                                                                                  |
| [         | Addition function.<br>Specifies positive value.    | Enters open bracket.                                                                              | Enters letter X.                                                                                  |
| ]         | Subtraction function.<br>Specifies negative value. | Enters close bracket.                                                                             | Enters letter Y.                                                                                  |
| <i>i</i>  | Enters number 0.                                   | Inputs imaginary number unit.                                                                     | Enters letter Z.                                                                                  |
| = SPACE   | Enters decimal point.                              | Enters character =.                                                                               | Enters a blank space.                                                                             |
| $\pi$ "   | Enables entry of exponent.                         | Inputs value of pi.<br>Enters pi symbol.                                                          | Enters double quotation mark.                                                                     |
| Ans       | Enter before value to specify as negative.         | Recalls most recent calculation result.                                                           |                                                                                                   |
|           | Displays result of calculation.                    | Inputs a new line.                                                                                |                                                                                                   |





## 6 P Button (In case of hang up)

---

Pressing the P button resets the calculator to its initial defaults.

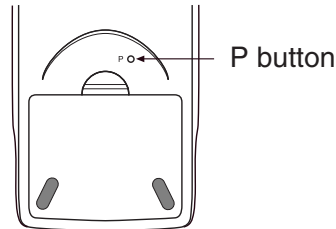

### Warning!

Never perform this operation unless you want to totally clear the memory of the calculator. If you need the data currently stored in memory, be sure to write it down somewhere before performing the P button operation.

- Pressing the P button while a calculation operation is being performed (while the calculator is performing a calculation internally) deletes all data in memory.
- You can also reset the calculator using front panel key operations (see 9-4 Reset). Use the P button to reset only while the front panel keys are disabled for some reason.

---

### • DATA ERROR Message

A data error indicates that data in calculator memory is seriously corrupted. This can be due to exposure of the calculator to strong electrostatic charge, temperature extremes, high humidity, etc. A data error is indicated by appearance of the screen shown below.

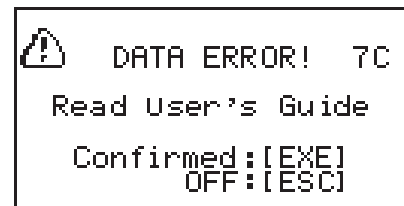

Press the **[EXE]** key to reset the calculator.

- The data error screen appears when you press the P button to reset the calculator or when you turn on calculator power.

### Warning!

Pressing **[EXE]** deletes all data in calculator memory.

If a data error occurs when you press **[EXE]**, it could mean that your calculator is malfunctioning. If the data error screen keeps appearing, press **[ESC]** to turn off power. Next, take the calculator to the retailer where you purchased it or to your local CASIO service provider.



## 7 Power Supply

---

This calculator is powered by four AAA-size (LR03 (AM4) or R03 (UM-4)) batteries. In addition, it uses a single CR2032 lithium battery as a back up power supply for the memory.

If either of the following messages appears on the display, immediately turn off the calculator and replace main batteries or the back up battery as instructed.

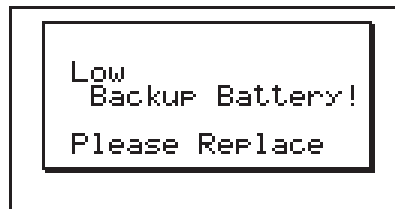
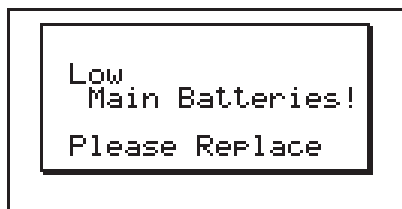

If you try to continue using the calculator, it will automatically turn off in order to protect memory contents. You will not be able to turn power back on until you replace batteries.

Be sure to replace the main batteries at least once every two years, no matter how much you use the calculator during that time.

The batteries that come with this calculator discharge slightly during shipment and storage. Because of this, they may require replacement sooner than the normal expected battery life.

### **Warning!**

All memory contents will be deleted if you remove both the main power supply and the memory back up batteries at the same time. If you ever remove both batteries, correctly reload them and then perform the reset operation.



## ■ Replacing Batteries

### Precautions:

Incorrectly using batteries can cause them to burst or leak, possibly damaging the interior of the calculator. Note the following precautions:

- Be sure that the positive (+) and negative (–) poles of each battery are facing in the proper directions.
- Never mix batteries of different types.
- Never mix old batteries and new ones.
- Never leave dead batteries in the battery compartment.
- Remove the batteries if you do not plan to use the calculator for long periods.
- Never try to recharge the batteries supplied with the calculator.
- Do not expose batteries to direct heat, let them become shorted, or try to take them apart.

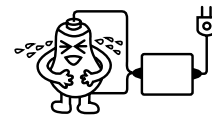
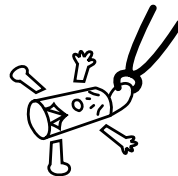

(Should a battery leak, clean out the battery compartment of the calculator immediately, taking care to avoid letting the battery fluid come into direct contact with your skin.)

Keep batteries out of the reach of small children. If swallowed, consult with a physician immediately.

### ● To replace the main power supply batteries

- \* Before replacing the main power supply batteries, turn on the calculator and check to see if the “Low Backup Battery!” message appears on the display. If it does, replace the memory back up battery before replacing the main power supply batteries.
- \* Never remove the main power supply and the memory back up batteries from the calculator at the same time.
- \* Never turn on the calculator while the main power supply batteries are removed or not loaded correctly. Doing so can cause memory data to be deleted and malfunction of the calculator. If mishandling of batteries causes such problems, correctly load batteries and then perform the RESET operation to resume normal operation.
- \* Be sure to replace all four batteries with new ones.



1. Press **SHIFT** **AC/ON** (OFF) to turn off the calculator.

**Warning!**

\*Be sure to turn the calculator off before replacing batteries. Replacing batteries with power on will cause data in memory to be deleted.

2. Making sure that you do not accidentally press the **AC/ON** key, slide the case onto the calculator and then turn it over.

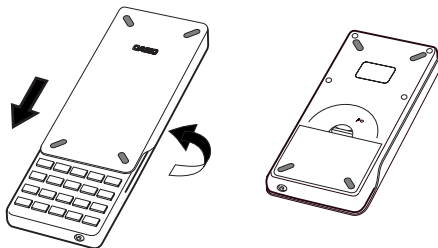

3. Remove the back cover from the calculator by pulling with your finger at the point marked ①.

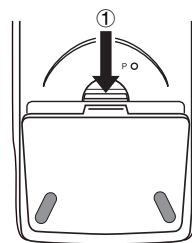

4. Remove the four old batteries.

5. Load a new set of four batteries, making sure that their positive (+) and negative (-) ends are facing in the proper directions.

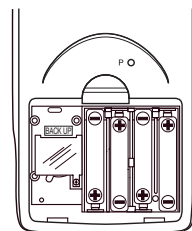

6. Replace the back cover.

7. Turn the calculator front side up and slide off its case. Next, press **AC/ON** to turn on power.



# Power supplied by memory back up battery while the main power supply batteries are removed for replacement retains memory contents.

# Do not leave the calculator without main power supply batteries loaded for long periods. Doing so can cause deletion of data stored in memory.

# If the figures on the display appear too light and hard to see after you turn on power, adjust the tint.

## ● To replace the memory back up battery

- \* Before replacing the memory back up battery, check to make sure the main batteries are not dead.
- \* Never remove the main power supply and the memory back up batteries from the calculator at the same time.
- \* Be sure to replace the back up power supply battery at least once 2 years, regardless of how much you use the calculator during that time. Failure to do so can cause data in memory to be deleted.

1. Press **SHIFT** **AC/ON** (OFF) to turn off the calculator.

### Warning!

- \* Be sure to turn the calculator off before replacing battery. Replacing battery with power on will cause data in memory to be deleted.

2. Making sure that you do not accidentally press the **AC/ON** key, slide the case onto the calculator and then turn it over.

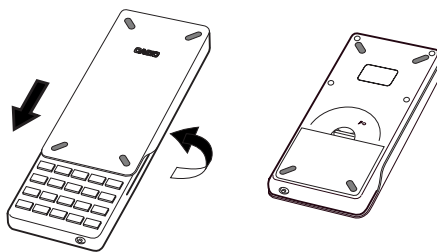

3. Remove the back cover from the calculator by pulling with your finger at the point marked ①.
4. Remove screw ① on the back of the calculator, and remove the back up battery compartment cover.
5. Insert a thin, pointed non-metal object (such as a toothpick) into the hole marked ② and remove the old battery.

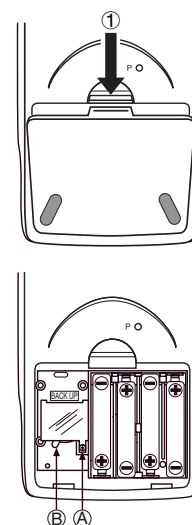

*α-7-5*  
*Power Supply*

6. Wipe off the surfaces of a new battery with a soft, dry cloth. Load it into the calculator so that its positive (+) side is facing up.
7. Install the memory protection battery cover onto the calculator and secure it in place with the screw. Next, replace the back cover.
8. Turn the calculator front side up and slide off its case. Next, press **AC/ON** to turn on power.

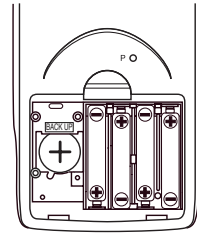

---

## ■ About the Auto Power Off Function

Calculator power turns off automatically if you do not perform any operation within the Auto Power Off trigger time you specify. You can specify either six minutes or 60 minutes as the trigger time (see “APO Settings” on page 9-3-1). To restore power, press **AC/ON**.



# MEMO

# MEMO



# MEMO

# CASIO®

**CASIO COMPUTER CO., LTD.**

6-2, Hon-machi 1-chome  
Shibuya-ku, Tokyo 151-8543, Japan

U.S. Pats. 4,938,263 / 4,410,956

Printed on recycled paper.  
Imprimé sur papier recyclé.  
Gedruckt auf wiederverwertetem Papier.

SA9906-A Printed in Malaysia  
A313984-11