

SHARP

POCKET COMPUTER

MODEL **PC-1245**

INSTRUCTION MANUAL

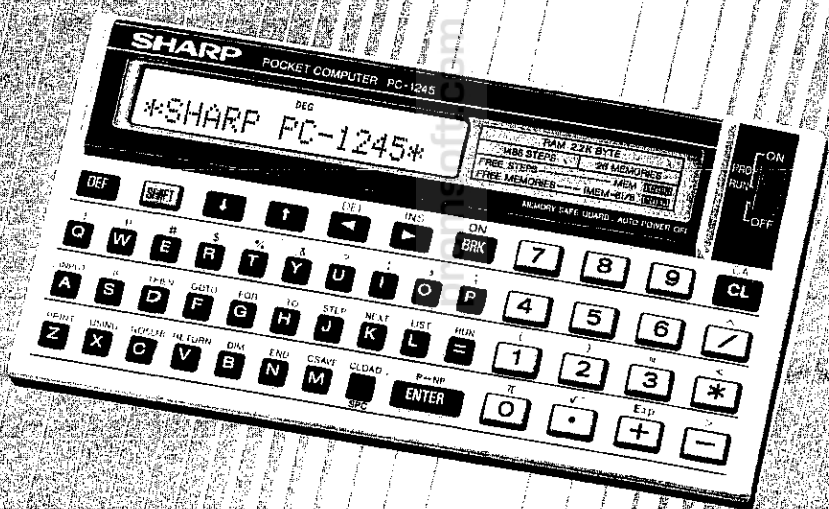

promsoft.com

TABLE OF CONTENTS

	Page
INTRODUCTORY NOTE	4
CHAPTER 1. HOW TO USE THIS MANUAL.....	5
CHAPTER 2. INTRODUCTION TO THE PC-1245.....	7
Description of System	7
Description of Keys	8
Description of Display	11
ALL RESET Button.....	12
Cell Replacement	14
CHAPTER 3. USING THE PC-1245 AS A CALCULATOR.....	17
Start Up	17
Shut Down.....	17
Auto Off	17
Some Helpful Hints	17
Key operation.....	19
Simple Calculations	19
Recalling Entries	20
Errors	24
Serial Calculations	24
Negative Numbers	26
Compound Calculations and Parentheses	26
Using Variables in Calculations.....	27
Chained Calculations	29
CHAPTER 4. CONCEPTS AND TERMS OF BASIC.....	30
Numeric Constants	30
Scientific Notation	30
Limits	31
Hexadecimal Numbers	32
String Constants	32
Variables	33
Simple Numeric Variables	33
Simple String Variables.....	33
Numeric Array Variables.....	33
String Array Variables	34
Preallocated Variables	34
Expressions	35
Numeric Operators	36
String Expressions	36

Table of Contents

	Page
Relational Expressions	37
Logical Expressions	38
Parentheses and Operator Precedence	40
Calculator Mode	40
Functions	40
CHAPTER 5. PROGRAMMING THE PC-1245	42
Programs	42
BASIC Statements	42
Line Numbers	42
BASIC Verbs	42
BASIC Commands	43
Modes	43
Beginning to Program on the PC-1245	44
Example 1 – Entering and Running a Program	44
Example 2 – Editing a Program	45
Example 3 – Using Variables in Programming	47
Example 4 – More Complex Programming	49
Storing Programs in the PC-1245 's Memory	50
CHAPTER 6. SHORTCUTS	52
The DEF Key and Labelled Programs	52
Template	53
CHAPTER 7. USING THE CE-125 PRINTER/MICROCASSETTE RECORDER	54
Description of System	54
Introduction to the Machine	54
Power	56
Connecting the PC-1245 to the CE-125	57
Loading the Paper	59
Using the Printer	60
Using the Microcassette Recorder	61
Using an External Tape Playback Unit	63
Care and Maintenance	64
Errors	64
CHAPTER 8. BASIC REFERENCE	67
Commands	67
Verbs	68
Functions	69

	Page
Pseudovariables	127
Numeric Functions	128
String Functions	133
CHAPTER 9. TROUBLESHOOTING	135
Machine Operation	135
BASIC Debugging	136
CHAPTER 10. MAINTENANCE OF THE PC-1245	137
APPENDICES	
Appendix A: Error Messages	138
Appendix B: ASCII Character Code Chart	140
Appendix C: Formatting Output	142
Appendix D: Expression Evaluation and Operator Priority	147
Appendix E: Feature Comparison of the PC-1211, PC-1245, PC-1251, and PC-1500	150
Appendix F: Numeric Precision on the PC-1245	155
Appendix G: Specifications	157
PROGRAM EXAMPLES	159
INDEX	205

INTRODUCTORY NOTE

Welcome to the world of **SHARP** owners!

Few industries in the world today can match the rapid growth and technological advances being made in the field of personal computing. Computers which just a short time ago would have filled a huge room, required a Ph.D. to program, and cost thousands of dollars, now fit in the palm of your hand, are easily programmed, and cost so little that they are within the reach of nearly everyone.

Your new **SHARP PC-1245** was designed to bring you all of the latest state of the art features of this computing revolution. As one of the most sophisticated hand held computers in the world today it incorporates many advanced capabilities:

- * **MEMORY SAFE GUARD** — the **PC-1245** remembers stored programs and variables even when you turn it off.
- * Battery powered operation for true portability.
- * **AUTO POWER OFF** function which conserves the batteries by turning the power off if no activity takes place within a specified time limit.
- * Programmable functions which allow the **PC-1245** to be used as a "smart" calculator.
- * An expanded version of **BASIC** which provides formatted output, two-dimensional arrays, variable length strings, program chaining and many other advanced features.
- * An optional printer/microcassette recorder (Model **CE-125**) for long term storage and hard copy printout of programs and data.

Congratulations on entering an exciting and enjoyable new world. We are sure that you will find this purchase one of the wisest you have ever made. The **SHARP PC-1245** is a powerful tool, designed to meet your specific mathematical, scientific, engineering, business and personal computing needs. With the **SHARP PC-1245** you can begin **NOW** providing the solutions you'll need tomorrow!

CHAPTER 1

HOW TO USE THIS MANUAL

This manual is designed to introduce you to the capabilities and features of your **PC-1245** and to serve as a valuable reference tool. Whether you are a "first time user" or an "old hand" with computers, you should acquaint yourself with the **PC-1245** by reading and working through Chapters 2 through 6.

- * Chapter 2 describes the physical features of the **PC-1245**.
- * Chapter 3 demonstrates the use of the **PC-1245** as a calculator.
- * Chapter 4 defines some terms and concepts which are essential for BASIC programming, and tells you about the special considerations of these concepts on the **PC-1245**.
- * Chapter 5 introduces you to BASIC programming on the **PC-1245**, showing you how to enter, correct, and run programs.
- * Chapter 6 discusses some shortcuts that make using your new computer easier and more enjoyable.

Experienced BASIC programmers may then read through Chapter 8 to learn the specific features of BASIC as implemented on the **PC-1245**. Since every dialect of BASIC is somewhat different, read through this material at least once before starting serious programming.

Chapter 8 is a reference section covering all the verbs, commands, and functions of BASIC arranged in convenient alphabetical groupings.

If you have never programmed in BASIC before, we suggest that you buy a separate book on beginning BASIC programming or attend a BASIC class, before trying to work through these chapters. This manual is not intended to teach you how to program.

The remainder of the manual consists of:

- * Chapter 7 — Basic information on the optional **CE-125 Printer/Micro-cassette Recorder**.
- * Chapter 9 — A troubleshooting guide to help you solve some operating and programming problems.

How to Use This Manual

- * Chapter 10 — The care and maintenance of your new computer.

Detailed Appendices, at the end of the manual, provide you with useful charts, comparisons, and special discussions concerning the use and operation of the PC-1245.

Using the Hard Cover

When the computer is not being used, mount the hard cover on the operation panel of the computer.

- When the computer is not used.

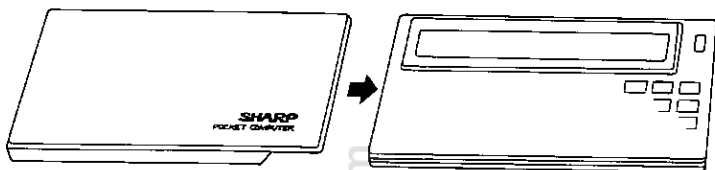

- When the computer is to be used.

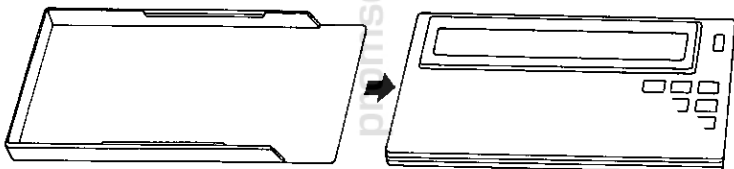

CHAPTER 2

INTRODUCTION TO THE PC-1245

The SHARP PC-1245 system consists of:

- * 52-character keyboard.
- * 16-character display.
- * Powerful BASIC in 24KB ROM.
- * 8-bit CMOS processor.
- * 2.2KB RAM.
- * Option: CE-125 Printer/Microcassette Recorder.

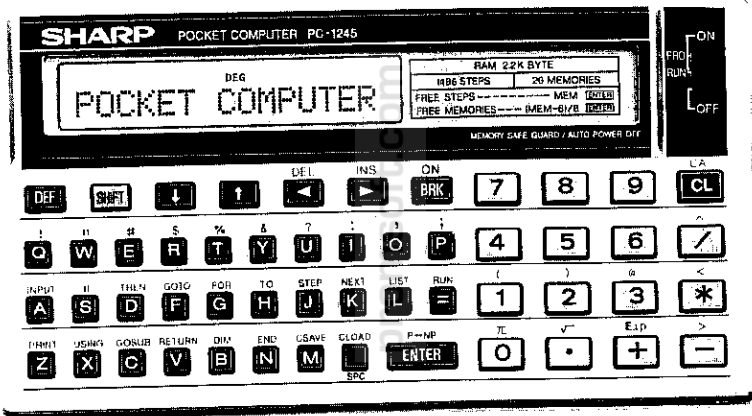

To familiarize you with the placement and functions of parts of the PC-1245 keyboard, we will now study each section of the keyboard. For now just locate the keys and read the description of each. In Chapter 3 we will begin using your new machine.

DESCRIPTION OF KEYS

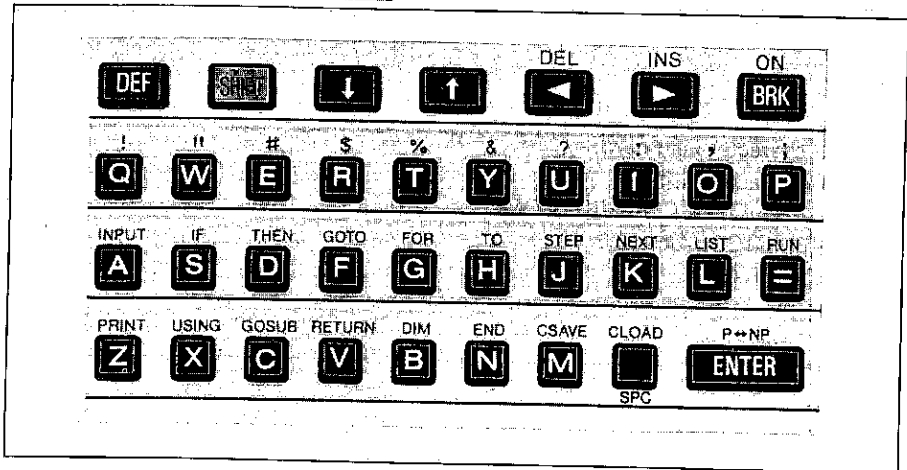

A ~ **Z** Alphabet keys. You are probably familiar with these keys from the standard typewriter keyboard. On the **PC-1245** display the characters always appear in the upper case.

= Equals key. On the **PC-1245** this key is **not** used to indicate the end of a calculation; in BASIC programming this symbol has a special function.

SPaCe key. Pressing this key advances the cursor leaving a blank space. Pressing **SPC** while the cursor is positioned over a character, erases that character.



P←NP
ENTER **ENTER** key. When you type this key, whatever you previously typed is "entered" into the computer's memory. This key is similar to the Carriage Return key on a typewriter. You must press **ENTER** before the **PC-1245** will act on alphanumeric input from the keyboard. Pressing **SHIFT** before pressing this key will cause the **PC-1245** to switch on and off the printing of calculations on the the **CE-125** printer.



DEF **DEF** key. This is a special key used to execute BASIC programs.



SHIFT **SHIFT** key. Press this key before pressing any key which has a character above it and the character above is displayed. (Note: Not used to capitalize letters as all alphabet keys on the **PC-1245** are in the upper case).

↓ Down Arrow key. Press this key to display the next program line.

 Up Arrow key. Press this key to display the previous program line.



 Backspace key. This key allows you to move the cursor to the left without erasing previously typed characters. Pressing  before pressing this key will DELete whatever character the cursor is "on top of".



 Forward key. This key allows you to move the cursor to the right without erasing previously typed characters. Pressing  before pressing this key makes a space directly before the character the cursor is "on top of". You can then INSert new characters into this space.

 BREAK key. The  key temporarily interrupts a program which is being executed. Pressing this key after an AUTO OFF turns the computer back on.

! " #
\$ % &
? : ,
;

These symbols are found above the top row of alphabet keys. Pressing  and then the alphabet key under the character desired displays these symbols.

INPUT

IF

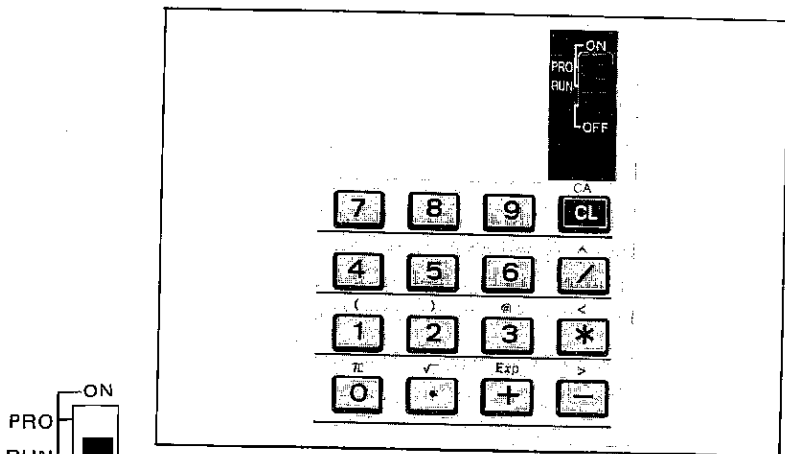
}
CLOAD

Preset command and statement keys. Pressing  and then the alphabet (including equals, space and ) key under the command and statement desired enters the designated command and statement to the PC-1245.



Use this power slide switch to turn ON and OFF the PC-1245. Notice that the machine is ON when this switch is positioned in any one of two modes, RUN and PROgram.

0 ~ **9** **.** Number keys. The layout of these keys is similar to that found on the standard calculator.

(**1** Number key. Pressing **SHIFT** and then this key produces a left parenthesis.

) **2** Number key. Pressing **SHIFT** and then this key produces a right parenthesis.

CA
CL Clear key. Pressing CClear erases the characters you have just typed in and "release" error. Pressing **SHIFT** before pressing this key activates the CA (reset) function. CA clears the display and resets the computer.

/ Division key. Press this key to include the division operator in calculations. Pressing **SHIFT** and then this key will display the "power" symbol, indicating that a number is to be raised to a specific power.

^
***** Multiplication key. Press this key to include the multiplication operator in calculations. Pressing **SHIFT** and then this key displays the "less than" character.

>
- Subtraction key. Press this key to include the subtraction operator in calculations. Pressing **SHIFT** and then this key displays the "greater than" character.

Exp
+ Addition key. Press this key to include the addition operator in calculations. Pressing **SHIFT** and then this key displays the exponentiation character used in scientific notation.

π $\sqrt{\quad}$ @ These three characters are found above the zero, decimal point and 3 keys. They are displayed by pressing **SHIFT** and then the character under the symbol desired.

DESCRIPTION OF DISPLAY

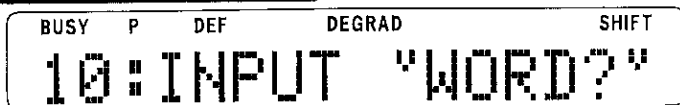

The liquid crystal display of the **SHARP PC-1245** shows up to 16 characters at one time. Although you may input up to 80 characters including **ENTER** in one line, only the first 16 characters are displayed. To review the remaining characters in a line, move the cursor to the far right and the display will 'scroll' — that is as characters drop off the left, new characters appear on the right.

The display consists of:

- $\>$ The prompt. This symbol appears when the computer is awaiting input. As you type, the prompt disappears and is replaced by the cursor.
- The cursor. This symbol (the underline) tells you the location of the next character to be typed in. As you begin typing the cursor replaces the prompt. The cursor is also used to position the computer over certain characters when using the **INSert** and **DELeTe** functions.
- BUSY** Program Execution Indicator. When the **PC-1245** is executing a program this indicator is lit (except when characters are displayed). The **PC-1245** will not undergo **AUTO OFF** while the **BUSY** indicator is on. **BUSY** disappears from the display when execution is completed.
- P** Printer Indicator. This indicator appears whenever you elect the print option when using the **PC-1245** as a calculator.
- DEF** Definable Mode Indicator. This symbol lights up whenever you press the **DEF** key.
- DEGRAD** Angular Measurement Indicator. This indicator displays the current unit of angles for the input of trigonometric functions. Depending on the mode in use the display will read **DEG** (degrees), **RAD** (radians), or **GRAD** (gradients).
- SHIFT** Shift Key Indicator. This indicator lights up when the **SHIFT** key has been depressed. Remember, the **SHIFT** key must be released before depressing any other key.

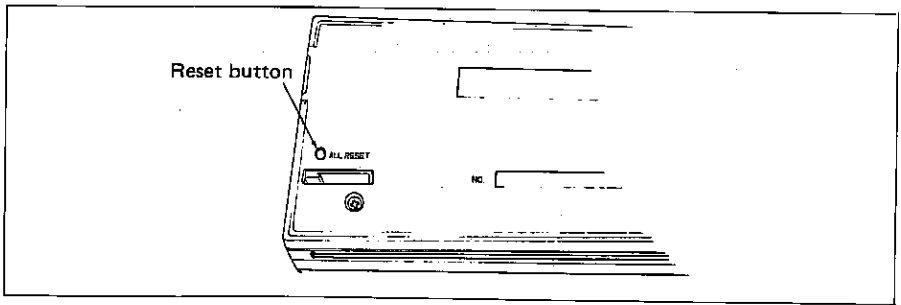

ALL RESET: Reset button. This button is used to reset the computer when CLeAr or CA is not sufficient to correct the problem.

NOTE

To reset the PC-1245 hold down any key on the keyboard and simultaneously press the RESET button on the back. This preserves all programs, variables, and reserve memory.

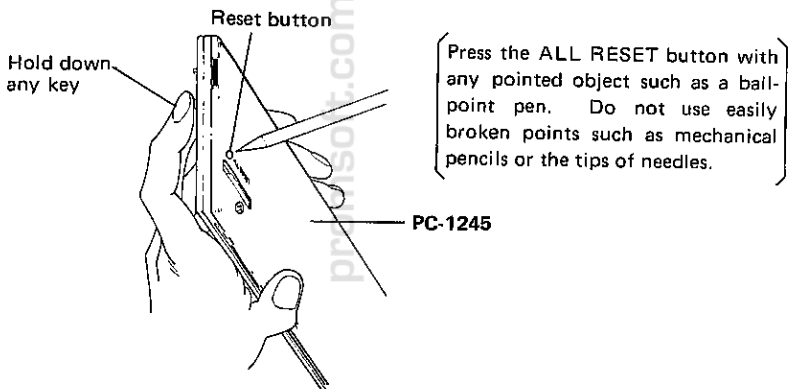

If you get no response from any key even when the above operation is performed, push RESET button without any key.

This operation will clear the program, data and all reserved contents, so do not press the RESET button without any key except when necessary.

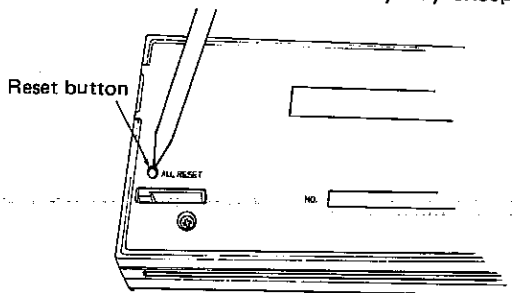

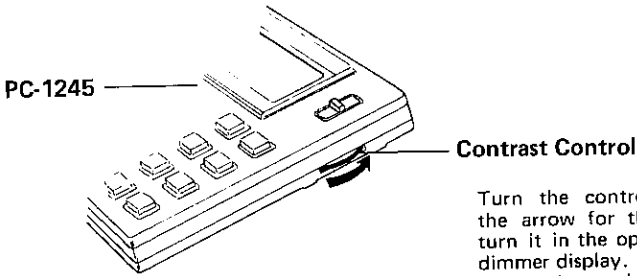

Turn the control in the direction of the arrow for the clearer display, and turn it in the opposite direction for the dimmer display. Adjust it so that the display is easy to see.

Reading the Table Beside the Display

	RAM 2.2K BYTE		← ②
① →	1486 STEPS	26 MEMORIES	← ③
	FREE STEPS - - - - -	MEM <input type="button" value="ENTER"/>	← ④
⑤ →	FREE MEMORIES - - -	(MEM-6) / 8 <input type="button" value="ENTER"/>	

- ①: indicates the available program size for the computer (1486 steps or 1486 bytes).
- ②: Indicates the RAM capacity in the computer (2.2 KB).
- ③: Indicates the number of memory locations (space for 26 fixed variables).
- ④: Indicates the method of determining the size of the vacant program data area.
- ⑤: Indicates the method of determining the number of variables which can be used by one variable name (array variable).

Step: Unit for counting statements, symbols or characters that constitute a program. Used to denote the program size.

Byte: A binary number that is eight binary bits or three octal digits or two hexadecimal digits long. Generally can be thought of as one character.

When denoting the program size, the number of steps is equal to the number of bytes.

CELL REPLACEMENT

The PC-1245 operates on the lithium cell alone. When connected to the CE-125, the PC-1245 can also be supplied from the CE-125 if it has enough power voltage and the lithium cell power decreases. This minimizes the power consumption of the lithium cell.

When replacing the cells these cautionary instructions will eliminate many problems:

- Always replace both of the cells at the same time.
- Do not mix a new cell with a used cell.
- Use only: Lithium cell (type CR-2032), two required

INSTALLING THE CELLS

The display is dim and uneasy to see when viewed from the front even by turning the contrast control on the right of the computer counterclockwise as far as it goes. This indicates that the cell power is consumed. In this case, replace the cell promptly. (Using the optional CE-125 peripheral equipment, record programs and data on tape in advance.)

- (1) Turn off the computer by setting the power slide switch to the OFF position.
- (2) Remove the screws from the back cover with a small screw driver. (Fig. 1)

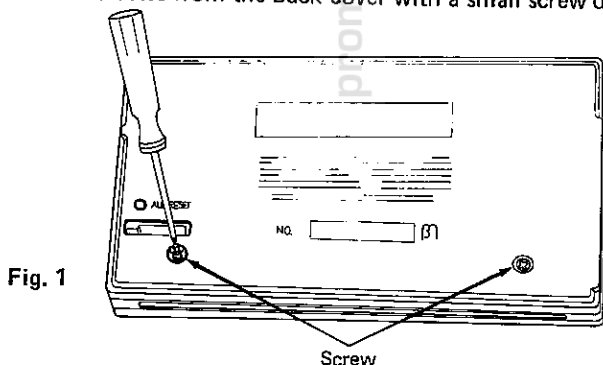

- (3) Remove the cell cover by sliding it in the direction of the arrow shown in Figure 2.

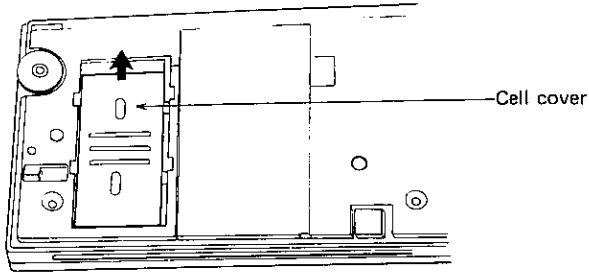

Fig. 2

- (4) Replace the two cells. (Fig. 3)

Always replace both of the cells at the same time.

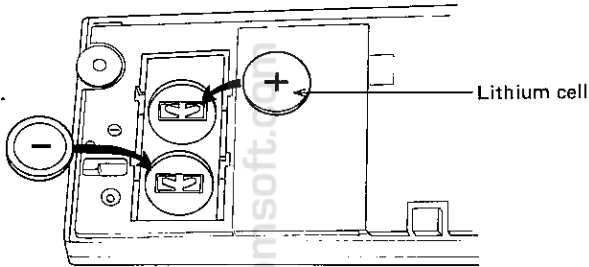

Fig. 3

- (5) Replace the cell cover by sliding it in the reverse direction of the arrow shown in figure 2.
- (6) Hook the claws of the back cover into the slits of the computer proper. (Fig. 4)

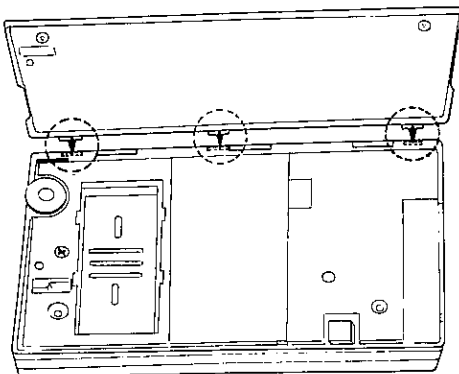
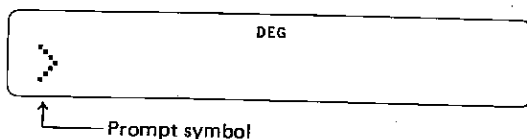



Fig. 4

Introduction to the PC-1245

- (7) Push the back cover in slightly while replacing the screws.
- (8) Turn on the computer by setting the power slide switch to the ON position and press the RESET button to clear the computer.
The display should look like this:



If the display is blank or displays any other symbol than the prompt , remove the cells and install them again, then check the display.

NOTE:

Keeping a dead cell in the computer may result in damage to the computer from solvent leakage of the cell. Remove a dead cell promptly.

CAUTION: Keep cell out of reach of children.

CHAPTER 3

USING THE PC-1245 AS A CALCULATOR

Now that you are familiar with the layout and components of the SHARP PC-1245, we will begin investigating the exciting capabilities of your new computer.

Because the PC-1245 allows you the full range of calculating functions, plus the increased power of BASIC programming abilities (useful in more complex calculations), it is commonly referred to as a "smart" calculator. That, of course, makes you a "smart" user!

(Before using the PC-1245, be sure that the batteries are correctly installed.)

Start Up

To turn ON the PC-1245, slide the power switch up and select one of two modes, RUN or PRO. For use as a calculator, the PC-1245 must be in the RUN mode. When the machine is ON the prompt (>) will appear on the display.

Shut Down

To turn OFF the PC-1245, slide the power switch to the OFF position.

When you turn OFF the machine, you clear (erase) the display. However, the PC-1245 does remember all programs, and mode setting which were in use when the computer was turned OFF. All of these settings are still in effect when the machine is turned back ON.

When the BEEP instruction or CLOAD command is executed, stop the execution by pressing the **[BRK]** key and slide the power switch to the OFF position.

Auto Off

In order to conserve on battery wear, the PC-1245 automatically powers down when no keys have been pressed for about 11 minutes. (Note: The PC-1245 will not AUTO OFF while you are executing a program.)

To restart the computer after a AUTO OFF press the **[ON
BRK]** key. All settings will be exactly as they were when the AUTO OFF occurred.



Some Helpful Hints

Until you are used to your new machine, you are bound to make mistakes while entering data. Later we will discuss some simple ways to correct these mistakes. For now, if you get an Error Message, press CLEAr and retype the entry. If the computer "hangs up" — you cannot get it to respond at all — press the ALL RESET button (See Chapter 2).





Using the PC-1245 as a Calculator

The PROMPT (>) tells you that the PC-1245 is awaiting input. As you enter data the prompt disappears and the CURSOR (_) moves to the right indicating the next available location in the display.

The right  and left  arrows move the cursor within a line.





 informs the PC-1245 that you are finished entering data and signals the computer to perform the indicated operations. **YOU MUST PRESS  AT THE END OF EACH LINE OF INPUT OR YOUR CALCULATIONS WILL NOT BE ACTED UPON BY THE COMPUTER.**

When performing numeric calculations input appears on the left of the screen: the results appear on the right of the display.

When using the  key in conjunction with another key (to access square root for example) press , release the , then press the other key.  is active for only one key at a time.

Do not use dollar signs or commas when entering calculations into the PC-1245. These characters have special meaning in the BASIC programming language.

In this manual we use the \emptyset to indicate zero, so that you can distinguish between the number (\emptyset) and the letter (O).

To help get you started entering data correctly, we will show each keystroke necessary to type in the example calculations. When  is used we will represent the desired character in the following keystroke. For example pressing  and  will produce the (character. These keystrokes are written  .

Be sure to enter CLear after each calculation (unless you are performing serial calculations). CLear erases the display and resets the error conditon. It does not erase anything stored in the computer's memory.

Key operation

Now let's operate the keys. Set the switch to RUN and press the following keys while watching the display:

(Example)

PRINT Z	USING X	GGSUB C	→ Z X C _		
(1) 2	√ •	^e 3	→ Z X C 1 2 . 3 _	
CA CL	→ >				
INPUT A	RUN =	4	+	5	→ A = 4 + 5 _
					↑ Cursor

If you press an alphabet or number key, the item denoted on the key will be entered. When you wish to enter the character or symbol denoted above each key, press **SHIFT** before operating the key.

(Example)

↓ Clears the display.

CA CL	SHIFT	PRINT Z	→ P R I N T _			
SHIFT	[#] W	SHIFT	(SHIFT	√	→ P R I N T " (√ _

The **SHIFT** key is used to enter the characters or symbols labeled in brown above each key that has two functions. If you repeatedly press the **SHIFT** key, the **SHIFT** symbol in the top right corner of the display will go on and off. The **SHIFT** symbol indicates that the **SHIFT** key is activated and the characters labeled in brown can be entered.

Simple Calculations

The **PC-1245** performs calculations with ten-digit precision. If you have not already done so, turn ON your computer by setting it in the RUN mode. Now try these simple arithmetic examples. Remember to **CLear** between calculations.

Input	Display
5 0 + 5 0 ENTER	100.
1 0 0 - 5 0 ENTER	50.
6 0 * 1 0 ENTER	600.
3 0 0 / 5 ENTER	60.
1 0 SHIFT ^ 2 ENTER	100.
2 * SHIFT π ENTER	6.283185307
SHIFT $\sqrt{\quad}$ 6 4 ENTER	8.

Recalling Entries

Even after the PC-1245 has displayed the results of your calculation, you can re-display your last entry. To recall, use the left \blacktriangleleft and right \blacktriangleright arrows.

The left arrow \blacktriangleleft recalls the expression with the cursor positioned after the last character.

The right arrow \blacktriangleright recalls the expression with the cursor positioned "on top of" the first character.

Remember that the left and right arrows are also used to position the cursor along a line. The right and left arrows are very helpful in editing (or modifying) entries without having to retype the entire expression.

You will become familiar with the use of the right and left arrows in the following examples. Now, take the role of the manager and perform the calculations as we discuss them.

As the head of personnel in a large marketing division, you are responsible for planning the annual sales meeting. You expect 300 people to attend the three day conference. For part of this time, the sales force will meet in small groups. You believe that groups of six would be a good size. How many groups would this be?

Input	Display
3 0 0 / 6 ENTER	50.

On second thought you decide that groups containing an odd number of participants might be more effective. Recall your last entry using the \leftarrow arrow.

Input



Display

300 / 6 _

To calculate the new number of groups you must replace the six with an odd number. Five seems to make more sense than seven. Because you recalled using the \leftarrow arrow, the cursor is positioned at the end of the display. Use the \leftarrow to move the cursor one space to the left.

Input



Display

300 / 6

Notice that after you move the cursor it becomes a flashing block \blacksquare . Whenever you position the cursor "on top of" an existing character, it will be displayed as the flashing cursor.

Type in a 5 to replace the 6. One caution in replacing characters — once you type a new character over an existing character, the original is gone forever! You cannot recall an expression that has been typed over.

Input

5

ENTER

Display

300 / 5 _

60.

Sixty seems like a reasonable number of groups, so you decide that each small group will consist of five participants.

Recall is also useful to verify your last entry, especially when your results do not seem to make sense. For instance, suppose you had performed this calculation:

Input

3 0 / 5 ENTER

Display

6.

Using the PC-1245 as a Calculator



Even a tired, overworked manager like you realizes that 6 does not seem to be a reasonable result when you are dealing with hundreds of people! Recall your entry using the .

Input



Display

30 / 5

Because you recalled using the  the flashing cursor is now positioned over the first character in the display. To correct this entry you wish to insert an added zero. Using the , move the cursor until it is positioned over the zero. When making an INSert, you position the flashing cursor over the character **before** which you wish to make the insertion.

Input



Display

30 / 5

Use the INSert key to make space for the needed character.

Input



Display

3 0 / 5

Pressing INSert moves all the characters one space to the right, and inserts a bracketed open slot. The flashing cursor is now positioned over this open space, indicating the location of the next typed input. Type in your zero. Once the entry is corrected, display your new result.

Input



Display

300 / 5

60.

On the other hand, suppose that you had entered this calculation:

Input

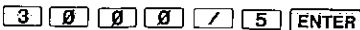

Display

600.

The results seem much too large. If you only have 300 people attending the meeting, how could you have 600 "small groups"? Recall your entry using the  .

Input



Display

3 0 0 0 / 5

The flashing cursor is now positioned over the first character in the display. To correct this entry eliminate one of the zeros. Using the  move the cursor to the first zero (or any zero). When deleting a character, you position the cursor "on top of" the character to be deleted.

Input



Display

3 0 0 0 / 5

Now use the DELete key to get rid of one of the zeros.

Input

Display

3 0 0 / 5

Pressing DELete causes all the characters to shift one space to the left. It deletes the character it is "on top of" and the space the character occupies. The flashing cursor stays in the same position indicating the next location for input. Since you have no other changes to make, complete the calculation.

Input



Display

6 0 .

(Note: Pressing the SPaCe key, when it is positioned over a character, replaces the character leaving a blank space. DELete eliminates the character and the space it occupied.)

Errors

Recalling your last entry is essential when you get the dreaded ERROR message. Let us imagine that, unintentionally, you typed this entry into the PC-1245:

Input

3 0 0 / / 5 ENTER

Display

ERROR 1

Naturally you are surprised when this message appears! ERROR 1 is simply the computer's way of saying, "I don't know what you want me to do here". To find out what the problem is, recall your entry using either the ◀ or ▶ arrow.

Input

◀

Display

300 / / 5

Whether you use the ◀ or ▶ key, the flashing cursor indicates the point at which the computer got confused. And no wonder, you have too many operators! To correct this error use the DELete key.

Input

SHIFT DEL ENTER

Display

60.

If, upon recalling your entry after an ERROR 1, you find that you have omitted a character, use the INSert sequence to correct it.

When using the PC-1245 as a calculator, the majority of the errors you encounter will be ERROR 1 (an error in syntax). For a complete listing of error messages, see APPENDIX A.

Serial Calculations

The PC-1245 allows you to use the results of one calculation as part of the following calculation.

Part of your responsibility in planning this conference is to draw up a detailed budget for approval. You know that your total budget is \$150.00 for each attendant. Figure your total budget:

Input

3 0 0 * 1 5 0 ENTER

Display

45000.

Of this amount you plan to use 15% for the final night's awards presentation. When performing serial calculations it is not necessary to retype your previous results, but DO NOT Clear between entries. What is the awards budget?

Input

[*] [.] [1] [5]

Display

45000. *. 15_

Notice that as you type in the second calculation (* . 15), the computer automatically displays the result of your first calculation at the left of the screen and includes it in the new calculation. In serial calculations the entry must begin with an operator. As always, you end the entry with **ENTER**:

NOTE: The $\%$ key cannot be used in the calculation. The $\%$ key should be used as a character only.

Example: 45000 [*] 15 [SHIFT] [%] → ERROR 1

Input**ENTER**Display

6750.

Continue allocating your budget. The hotel will cater your dinner for \$4000:

Input

[-] [4] [0] [0] [0]

Display

6750. -4000_

ENTER

2750.

Decorations will be \$1225:

Input[-] [1] [2] [2] [5] **ENTER**Display

1525.

Finally, you must allocate \$2200 for the speaker and entertainment:

Input[-] [2] [2] [0] [0] **ENTER**Display

-675.

Obviously, you will have to change either your plans or your allocation of resources!

Negative Numbers

Since you want the awards dinner to be really special, you decide to stay with the planned agenda and spend the additional money. However, you wonder what percentage of the total budget will be used up by this item. First, change the sign of the remaining sum:

Input

***** **-** **1**

ENTER

Display

-675.*-1_

675.

Now you add this result to your original presentation budget:

Input

+ **6** **7** **5** **0** **ENTER**

Display

7425.

Dividing by 45000 gives you the percentage of the total budget this new figure represents:

Input

/ **4** **5** **0** **0** **0** **ENTER**

Display

0.165

Fine, you decide to allocate 16.5% to the awards presentation.

Compound Calculations and Parentheses

In performing the above calculations, you could have combined several of these operations into one step. For instance, you might have typed both these operations on one line:

$$675+6750/45000$$

Compound calculations, however, must be entered very carefully:

675+6750/45000 might be interpreted as

$$\frac{675 + 6750}{45000}$$

or

$$675 + \frac{6750}{45000}$$

When performing compound calculations, the **PC-1245** has specific rules of expression evaluation and operator priority (see APPENDIX D). Be sure you get the calculation you want by using parentheses to clarify your expressions:

$$(675+6750) / 45000 \quad \text{or} \quad 675+(6750 / 45000)$$

To illustrate the difference that the placement of parentheses can make, try these two examples:

Input

SHIFT (6 7 5 + 6
7 5 0 SHIFT) / 4
5 0 0 0 ENTER

Display

0.165

6 7 5 + SHIFT (6
7 5 0 / 4 5 0 0
0 SHIFT) ENTER

675.15

Using Variables in Calculations

The **PC-1245** can store up to 26 simple numeric **variables** under the alphabetic characters A to Z. If you are unfamiliar with the concept of variables, they are more fully explained in Chapter 4. You designate variables with an Assignment Statement:

$$A = 5$$

$$B = -2$$

You can also assign the value of one variable (right) to another variable (left):

$$C = A + 3$$

$$D = E$$

A variable may be used in place of a number in any calculation.

Now that you have planned your awards dinner, you need to complete arrangements for your conference. You wish to allocate the rest of your budget by percentages also. First you must find out how much money is still available. Assign a variable (R) to be the amount left from the total:

Using the PC-1245 as a Calculator

Input

R = 4 5 0 0 0
- 7 4 2 5

ENTER

Display

R=45000-7425_

37575.

As you press **ENTER** the **PC-1245** performs the calculation and displays the new value of R. You can display the current value of any variable by entering the alphabetic character it is stored under:

Input

R ENTER

Display

37575.

You can then perform calculations using your variable. The value of (R) will not change until you assign it a new value.

You wish to allocate 60% of the remaining money to room rental:

Input

R * . 6 0

ENTER

Display

R * . 60_

22545.

Similarly, you want to allocate 25% of your remaining budget to conduct management training seminars:

Input

R * . 2 5 ENTER

Display

9393.75

Variables will retain their assigned values even if the machine is turned OFF or undergoes an AUTO OFF. Variables are lost only when:

- * You assign a new value to the same variable.
- * You type in CLEAR **ENTER** (not the CClear key).
- * You clear the machine using the ALL RESET button.
- * The batteries are changed.

There are certain limitations on the assignment of variables, and certain programming procedures which cause them to be changed. See Chapter 4 for a discussion of assignment. See Chapter 5 for a discussion of the use of variables in programming.

Chained Calculations

In addition to combining several operators in one calculation, the PC-1245 also allows you to perform several calculations one after the other — without having to press **ENTER** before moving on. You must separate the equations with commas. Only the result of the final calculation is displayed. (Remember too, that the maximum line length accepted by the computer is 80 characters including **ENTER**.)

You wonder how much money would have been available for rooms if you had kept to your original allocation of 15% for the awards dinner:

Input

R = . 8 5 * 4 5 0 0 0 , R * . 6 0 -
 0 0 0 SHIFT . R *
 . 6 0 0

Display

. 8 5 * 4 5 0 0 0 , R * . 6 0 -

Although the computer performs all the calculations in the chain, it displays only the final result:

Input

ENTER

Display

22950.

To find the value of R used in this calculation, enter R:

Input

R ENTER

Display

38250.

Now It's Your Turn

This concludes our discussion of using the PC-1245 as a calculator. Undoubtedly, as you become more familiar with your machine's capabilities and special features, you will find many new and useful applications for this "smart" calculator.

But calculating is only one of the many potential uses of the PC-1245. In the next chapter we will examine the concepts and terms of the BASIC language, as it is used by the PC-1245. Then you can begin to create your own, unique, problem-solving programs.

CHAPTER 4 CONCEPTS AND TERMS OF BASIC

In this Chapter we will examine some concepts and terms of the BASIC language. Because the **PC-1245** uses many features of BASIC when used as a calculator, some of these concepts are also useful for advanced calculator functions.

Numeric Constants

In Chapter 3 you entered simple numbers for use in calculations, without worrying about the different ways that numbers can be represented, or the range of numbers that the **SHARP PC-1245** can process. Some of you, however, may need or desire to know more about how this computer uses numbers.

The **SHARP PC-1245** recognizes three different ways to represent numbers:

- * Decimals.
- * Exponential or scientific notation.
- * Hexadecimal numbers.

Decimal numbers are familiar to most of you. Scientific notation and hexadecimal numbers may require some explanation.

Scientific Notation

People who need to deal with very large and very small numbers often use a special format called exponential or **scientific notation**. In scientific notation a number is broken down into two parts.

The first part consists of a regular decimal number between 1 and 10 . The second part represents how large or small the number is in powers of 10 .

As you know, the first number to the left of the decimal point in a regular decimal number shows the number of 1's, the second shows the number of 10 's, the third the number of 100 's, and the fourth the number of 1000 's. These are simply increasing powers of 10 :

$$10^0 = 1, 10^1 = 10, 10^2 = 100, 10^3 = 1000, \text{ etc.}$$

Scientific notation breaks down a decimal number into two parts: one shows what the numbers are, the second other shows how far a number is to the left, or right, of the decimal point. For example:

Hexadecimal Numbers

The decimal system is only one of many different systems to represent numbers. Another which has become quite important when using computers is the hexadecimal system. The hexadecimal system is based on 16 instead of 10. To write hexadecimal numbers you use the familiar 0 ~ 9 and 6 more "digits": A, B, C, D, E, and F. These correspond to 10, 11, 12, 13, 14, and 15. When you want the PC-1245 to treat a number as hexadecimal put an ampersand '&' character in front of the numeral:

```
&A    = 10
&10   = 16
&100  = 256
&FFFF = 65535
```

Those with some computer background may notice that the last number (65535) is the same as the largest number in the special group of limits discussed in the last paragraph. Hexadecimal notation is never required in using the PC-1245, but there are special applications where it is convenient.

String Constants

In addition to numbers, there many ways that the SHARP PC-1245 uses letters and special symbols. These letters, numbers, and special symbols are called characters. These characters are available on the PC-1245:

```
1 2 3 4 5 6 7 8 9 0
A B C D E F G H I J K L M N O P Q R S T U V W X Y Z
! " # $ % & ( ) * + , - . / : ; < = > ? @ √ π ^ E
```

In BASIC, a collection of characters is called a **string**. In order for the PC-1245 to tell the difference between a string and other parts of a program, such as verbs or variable names, you must enclose the characters of the string in quotation marks ("").

The following are examples of string constants:

```
"HELLO"
"GOODBYE"
"SHARP PC-1245"
```

The following are not valid string constants:

```
"COMPUTER ..... No ending quote
"ISN" T" ..... Quote can't be used within a string
```

Variables

In addition to constants, whose values do not change during a program, BASIC has **variables**, whose values can change. Variables are names used to designate locations where information is stored. These variables are like the letters used in algebraic equations. Just as there are numeric and string constants, there are numeric and string variables.

Simple Numeric Variables

You have already used **simple numeric variables** when working with the **PC-1245** as a calculator in Chapter 3. Simple numeric variables are used to store a single number and are designated by a single letter (A – Z):

$$A = 5$$

$$C = 12.345$$

Simple numeric variables may take the same range of values as numeric constants.

Simple String Variables

String variables are used to hold strings (a collection of characters). They are named by a single letter followed by a dollar sign:

A\$

C\$

A string variable may be from 0 to 7 characters long. If you try to store more than 7 characters in a string variable, only the first 7 will be saved. When a string variable is empty, or its length is zero, it is called NUL or the NUL string.

Numeric Array Variables

For some purposes it is useful to deal with numbers as an organized group, such as a list of scores or a tax table. In BASIC these groups are called **arrays**. An array can be either **one-dimensional**, like a list, or **two-dimensional**, like a table. Array names are designated in the same manner as simple variable names, except that they are followed by parentheses. The elements of an array are referred to by a number inside the parentheses; when the array is two dimensional there must be two numbers separated by a comma:

A(5) The fifth element of a one-dimensional array A

B(3,2) The element in the third row and second column of a two dimensional B array

Concepts and Terms of BASIC

Arrays are created using the DIM verb or command. To create an array you give its name and its size:

```
DIM X(5)
DIM Y(32)
```

Note that DIM X(5) actually creates an array with six entries:

```
X(0) X(1) X(2) X(3) X(4) X(5)
```

Similarly DIM Y(2, 2) creates an extra 0 row and a extra 0 column:

```
Y(0,0) Y(0,1) Y(0,2)
Y(1,0) Y(1,1) Y(1,2)
Y(2,0) Y(2,1) Y(2,2)
```

This extra element, or row and column, is often used by programmers to hold partial products during computations. For example, you might total the elements of the X array by summing them into X(0).

The form and use of the DIM verb is covered in detail in Chapter 8.

Note: the A array **does not** have the extra 0 element and does not need to be DIMensioned (see section below on Preallocated Variables).

String Array Variables

String array variables have the same relationship to numeric array variables as simple string variables have to simple numeric variables, — their names are the same except for the addition of a dollar sign:

```
C$(5)    The fifth string element in the array C$
```

With string arrays the length of each string will be 16 characters unless you specifically choose a different length in the DIM statement:

```
DIM X$(12)*8    DIMensions a string array with 13 elements, each a string
                  8 characters long
```

Chapter 8 details the use of the DIM statement.

Preallocated Variables

Some of the variables which you will use most frequently have already been allocated space in the PC-1245's memory. Twenty-six locations are reserved for numeric variables A — Z, string variables A\$ — Z\$, numeric array A(26), OR string array A\$(26). The locations are assigned as follows:

<u>Loc.</u>	<u>Num. Var.</u>	<u>Str. Var.</u>	<u>Num. Arr. Var.</u>	<u>Str. Arr. Var.</u>
1	A	A\$	A(1)	A\$(1)
2	B	B\$	A(2)	A\$(2)
3	C	C\$	A(3)	A\$(3)
4	D	D\$	A(4)	A\$(4)
⋮	⋮	⋮	⋮	⋮
23	W	W\$	A(23)	A\$(23)
24	X	X\$	A(24)	A\$(24)
25	Y	Y\$	A(25)	A\$(25)
26	Z	Z\$	A(26)	A\$(26)

NOTE: There are only twenty-six locations and you must be careful not to use the same location in two different ways.

If you use location 24 to store a numeric value in X and then try to print X\$, you will get an ERROR 9. Similarly, if you store a number in A(24) and then store another number in X you will over-write the first number, but you will not get an error message.

The A() and A\$() arrays are different from all other arrays – they don't have a zero element. It is possible to use DIM to make A() or A\$() larger than 26, but if you do, the first 26 elements will use the reserved locations while the elements from 26 on will be stored in a different part of the memory. The only way that you will notice this, however, is that these 26 special locations are not cleared when you RUN a program. All other array variables are cleared with each new RUN. By using good programming practice and always initializing your variables to the desired value, you will avoid any possible confusion.

If DIM is used to allocate the A() or A\$() arrays larger than 26 elements, there are certain special conditions in which an error can cause the part of the array from A(27) or A\$(27) on to become inaccessible. If this occurs, it is necessary to re-dimension the array.

Expressions

An **expression** is some combination of variables, constants, and operators which can be evaluated to a single value. The calculations which you entered in Chapter 3 were examples of expressions. Expressions are an intrinsic part of BASIC programs. For example, an expression might be a formula that computes an answer to some equation, a test to determine the relationship between two quantities, or a means to format a set of strings.

Numeric Operators

The **PC-1245** has five **numeric operators**. These are the arithmetic operators which you used when exploring the use of the **PC-1245** as a calculator in Chapter 3:

- + Addition
- Subtraction
- * Multiplication
- / Division
- ^ Power

A **numeric expression** is constructed in the same way that you entered compound calculator operations. Numeric expressions can contain any meaningful combination of numeric constants, numeric variables, and these numeric operators:

$$(A * B) \wedge 2$$
$$A(2, 3) + A(3, 4) + 5.0 - C$$
$$(A/B) * (C+D)$$

In certain circumstances the multiplication operator can be implied:

$$2A \text{ is the same as } 2 * A$$
$$7C \text{ is the same as } 7 * C$$
$$ABC \text{ is the same as } A * B * C$$

As you can see from the last example, there is a possibility that implied multiplication could be confused with other BASIC words, so don't use this form unless the context is very clear.

String Expressions

String expressions are similar to numeric expressions except that there is only one string operator — concatenation (+). This is the same symbol used for plus. When used with a pair of strings, the + attaches the second string to the end of the first string and makes one longer string. You should take care in making more complex string concatenations and other string operations because the work space used by the **PC-1245** for string calculations is limited to only 79 characters.

NOTE: String quantities and numeric quantities cannot be combined in the same expression unless one uses one of the functions which convert a string value into a numeric value or vice versa:

$"15" + 10$ is illegal
 $"15" + "10"$ is $"1510"$, not $"25"$

Relational Expressions

A **relational expression** compares two expressions and determines whether the stated relationship is True or False. The relational operators are:

- > Greater Than
- >= Greater Than or Equal To
- = Equals
- <> Not Equal To
- <= Less Than or Equal To
- < Less Than

The following are valid relational expressions:

$A < B$
 $C(1, 2) >= 5$
 $D(3) <> 8$

If A was equal to 10, B equal to 12, C(1, 2) equal to 6, and D(3) equal to 9, all of these relational expressions would be True.

Character strings can also be compared in relational expressions. The two strings are compared character by character according to their ASCII value starting at the first character (see Appendix B for ASCII values). If one string is shorter than the other, a 0 or NUL will be used for any missing positions. All of the following relational expressions are True:

$"ABCDEF" = "ABCDEF"$
 $"ABCDEF" <> "ABCDE"$
 $"ABCDEF" > "ABCDE"$

Relational expressions evaluate to either True or False. The **PC-1245** represents True by a 1; False is represented by a 0. In any logical test an expression which evaluates to 1 or more will be regarded as True while one which evaluates to 0 or less will be considered False. Good programming practice, however, dictates the use of an explicit relational expression instead of relying on this coincidence.

Logical Expressions

Logical expressions are relational expressions which use the operators AND, OR, and NOT. AND and OR are used to connect two relational expressions; the value of the combined expression is shown in the following tables:

A AND B		Value of A	
		True	False
Value of B	True	True	False
	False	False	False

A OR B		Value of A	
		True	False
Value of B	True	True	True
	False	True	False

(Note: Value of A and B must be 0 or 1)

- Decimal numbers can be expressed in the binary notation of 16 bits as follows:

DECIMAL NOTATION	BINARY NOTATION OF 16-BIT
32767	0111111111111111
⋮	
3	0000000000000011
2	0000000000000010
1	0000000000000001
0	0000000000000000
-1	1111111111111111
-2	1111111111111110
-3	1111111111111101
⋮	
-32768	1000000000000000

The negative (NOT) of a binary number 0000000000000001 is taken as follows:

NOT 0000000000000001
 (Negative) → 1111111111111110

Thus, 1 is inverted to 0, and 0 to 1 for each bit, which is called "to take negative (NOT)."

Then, the following will result when 1 and NOT 1 are added together:

$$\begin{array}{r} 0000000000000001 \quad (1) \\ +) \quad 1111111111111110 \quad (\text{NOT } 1) \\ \hline 1111111111111111 \quad (-1) \end{array}$$

Thus, all bits become 1. According to the above number list, the bits become -1 in decimal notation, that is $1 + \text{NOT } 1 = -1$.

The relationship between numerical value X and its negative (NOT X) is:

$$X + \text{NOT } X = -1$$

This results in an equation of NOT $X = -X - 1$

$$\text{i.e. NOT } X = -(X + 1)$$

From the equation the following are found to result.

$$\begin{array}{l} \text{NOT } 0 = -1 \\ \text{NOT } -1 = 0 \\ \text{NOT } -2 = 1 \end{array}$$

More than two relational expressions can be combined with these operators. You should take care to use parentheses to make the intended comparison clear.

$$\begin{array}{l} (A < 9) \text{ AND } (B > 5) \\ (A \geq 10) \text{ AND NOT } (A > 20) \\ (C = 5) \text{ OR } (C = 6) \text{ OR } (C = 7) \end{array}$$

The **PC-1245** implements logical operators as "bitwise" logical functions on 16 bit quantities. (See note on relational expressions and True and False). In normal operations this is not significant because the simple 1 and 0 (True and False) which result from a relational expression uses only a single bit. If you apply a logical operator to a value other than 0 or 1, it works on each bit independently. For example if A is 17, and B is 22, (A OR B) is 23:

$$\begin{array}{l} 17 \text{ in binary notation is } 10001 \\ 22 \text{ in binary notation is } 10110 \\ 17 \text{ OR } 22 \text{ is } \quad \quad \quad 10111 \quad (1 \text{ if } 1 \text{ in either number, otherwise } 0) \\ 10111 \text{ is } 23 \text{ in decimal.} \end{array}$$

Concepts and Terms of BASIC

If you are a proficient programmer, there are certain applications where this type of operation can be very useful. Beginning programmers should stick to clear, simple True or False relational expressions.

Parentheses and Operator Precedence

When evaluating complex expressions the PC-1245 follows a predefined set of priorities which determine the sequence in which operators are evaluated. This can be quite significant:

$5 + 2 * 3$ could be

$$5 + 2 = 7$$

$$7 * 3 = 21$$

or

$$2 * 3 = 6$$

$$6 + 5 = 11$$

The exact rules of "operator precedence" are given in Appendix D.

To avoid having to remember all these rules and to make your program clearer, always use parentheses to determine the sequence of evaluation. The above example is clarified by writing either:

$$(5 + 2) * 3$$

or

$$5 + (2 * 3)$$

Calculator Mode

In general, any of the above expressions can be used in the calculator mode well as in programming a BASIC statement. In the RUN mode an expression is computed and displayed immediately. For example:

Input

$(5 > 3)$ AND $(2 < 6)$

Display

1.

The 1 means that the expression is True.

Functions

Functions are special components of the BASIC language which take one value and transform it into another value. Functions act like variables whose value is determined by the value of other variables or expressions. ABS is a function which produces the absolute value of its argument:

ABS (-5) is 5

ABS (6) is 6

LOG is a function which computes the log to the base 10 of its argument.

LOG (100) is 2
 LOG (1000) is 3

A function can be used any place that a variable can be used. Many functions do not require the use of parentheses:

LOG 100 is the same as LOG (100)

You must use parentheses for functions which have more than one argument. Using parentheses always makes programs clearer.

See Chapter 8 for a complete list of functions available on the **PC-1245**.

CHAPTER 5

PROGRAMMING THE PC-1245

In the previous chapter we examined some of the concepts and terms of the BASIC programming language. In this chapter you will use these elements to create programs on the PC-1245. Let us reiterate however, this is **not** a manual on how to program in BASIC. What this chapter will do is familiarize you with the use of BASIC on your PC-1245.

Programs

A **program** consists of a set of instruction to the computer. Remember the PC-1245 is only a machine. It will perform the exact operations that you specify. You, the programmer, are responsible for issuing the correct instructions.

BASIC Statements

The PC-1245 interprets instructions according to a predetermined format. This format is called a **statement**. You always enter BASIC statements in the same pattern. Statements must start with a line number:

```
10: PRINT "HELLO"  
20: READ B (10)  
30: END
```

Line Numbers

Each line of a program must have a unique line number — any integer between 1 and 999. Line numbers are the reference for the computer. They tell the PC-1245 the order in which to perform the program. You need not enter lines in sequential order (although if you are a beginning programmer, it is probably less confusing for you to do so). The computer always begins execution with the lowest line number and moves sequentially through the lines of a program in ascending order.

When programming it is wise to allow increments in your line numbering (10, 20, 30, . . . 10, 30, 50 etc). This enables you to insert additional lines if necessary. **CAUTION: Do not use the same line numbers in different programs.** If you use the same line number, the oldest line with that number is deleted when you enter the new line.

BASIC Verbs

All BASIC statements must contain **verbs**. Verbs tell the computer what action to perform. A verb is always contained within a program, and as such is not acted upon immediately.

```

10: PRINT "HELLO"
20: READ B (10)
30: END

```

Some statements require or allow an **operand**:

```

10: PRINT "HELLO"
20: READ B (10)
30: END

```

Operands provide information to the computer telling it what data the verb will act upon. Some verbs require operands, with other verbs they are optional. Certain verbs do not allow operands. (See Chapter 8 for a complete listing of BASIC verbs and their use on the **PC-1245**).

BASIC Commands

Commands are instructions to the computer which are entered outside of a program. Commands instruct the computer to perform some action with your program or to set modes which effect how your programs are executed.

Unlike verbs, commands have immediate effects — as soon as you complete entering the command (by pressing the **ENTER** key), the command will be executed. Commands are **not** preceded by a line number:

```

RUN
NEW
RADIAN

```

Some verbs may also be used as commands. (See Chapter 8 for a complete listing of BASIC commands and their use on the **PC-1245**).

Modes

You will remember that when using the **PC-1245** as a calculator, it is set in the RUN mode.

The RUN mode is also used to execute the programs you create.

The PROgram mode is used to enter and edit your programs.

Beginning to Program on the PC-1245

After all your practice in using the PC-1245 as a calculator you are probably quite at home with the keyboard. From now on, when we show an entry, we will **not** show every keystroke. Remember to use **SHIFT** to access characters above the keys and **END EVERY LINE BY PRESSING THE ENTER KEY**.

Now you are ready to program! Set the slide switch to the PROgram mode and enter this command:

Input

NEW

Display

>

The NEW command clears the PC-1245's memory of all existing programs and data. The prompt appears after you press **ENTER**, indicating that the computer is awaiting input.

Example 1 – Entering and Running a Program

Make sure the PC-1245 is in the PRO mode and enter the following program:

Input

10 PRINT "HELLO"

Display

10: PRINT "HELLO"

Notice that when you push **ENTER** the PC-1245 displays your input, automatically inserting a colon (:) between the line number and the verb. Verify that the statement is in the correct format.

Now slide the selector switch to the RUN mode:

Input

RUN

Display

HELLO

Since this is the only line of the program, the computer will stop executing at this point. Press **ENTER** to get out of the program and reenter RUN if you wish to execute the program again.

Example 2 – Editing a Program

Suppose you wanted to change the message that your program was displaying, that is you wanted to edit your program. With a single line program you could just retype the entry, but as you develop more complex programs editing becomes a very important component of your programming. Let's edit the program you have just written.

Are you still in the RUN mode? If so switch back to the PROgram mode.

You need to recall your program in order to edit it. Use the Up Arrow (↑) to recall your program. If your program was completely executed, the (↑) will recall the last line of the program. If there was an error in the program, or if you used the BREAK (BRK) key to stop execution, the (↑) will recall the line in which the error or BREAK occurred. To make changes in your program use the (↑) to move up in your program (recall the previous line) and the (↓) to move down in your program (display the next line). If held down the (↑) and the (↓) will scroll vertically, that is they will display each line moving up or down in your program.

You will remember that to move the cursor within a line you use the ► (right arrow) and ◀ (left arrow). Using the ► position the cursor over the first character you wish to change:

Input

↑

Display

10: PRINT "HELLO"

◀◀◀◀

10 PRINT "HELLO"

Notice that the cursor is now in the flashing block form indicating that it is "on top of" an existing character. Type in:

Input

GOOD"

Display

10 "GOOD"!_

Don't forget to press **ENTER** at the end of the line. Switch into the RUN mode.

Input

RUN

Display

ERROR 1 IN 10

This is a new kind of error message. Not only is the error type identified (our old friend the syntax error) but the **line number** in which the error occurs is also indicated.

Switch back into the PROgram mode. You must be in the PROgram mode to make changes in a program. Using the ↑, recall the last line of your program.

Input

↑

Display

10: PRINT "GOOD" !

The flashing cursor is positioned over the problem area. In Chapter 4 you learned that when entering string constants in BASIC all characters must be contained within quotation marks. Use the DELeTe key to eliminate the "!":

Input

DEL

Display

10 PRINT "GOOD" _

Now let's put the ! in the correct location. When editing programs, DELeTe and INSert are used in exactly the same way as they are in editing calculations (See Chapter 3). Using the ◀ position the cursor on top of the character which will be the first character following the insertion.

Input

◀

Display

10 PRINT "GOOD" !

Press the INSert key. A □ will indicate the spot where the new data will be entered:

Input

INS

Display

10 PRINT "GOOD" □

Type in the !. The display looks like this:

Input

!

Display

10 PRINT "GOOD!"

Remember to press **ENTER** so the correction will be entered into the program.

NOTE: If you wish to DELETE an entire line from your program just type in the line number and the original line will be eliminated.

Example 3 — Using Variables in Programming

If you are unfamiliar with the use of numeric and string variables in BASIC, reread these sections in Chapter 4.

Using variables in programming allows much more sophisticated use of the PC-1245's computing abilities.

Remember, you assign simple numeric variables using any letter from A to Z:

```
A = 5
```

To assign string variables you also use a letter, followed by a dollar sign. **Do not use the same letter in designating a numeric and a string variable.** You cannot designate A and A\$ in the same program.

Remember that simple string variables cannot exceed 7 characters in length:

```
A$ = "TOTAL"
```

The values assigned to a variable can change during the execution of a program, taking on the values typed in or computed during the program. One way to assign a variable is to use the INPUT verb. In the following program the value of A\$ will change in response to the data typed in answering the inquiry "WORD?". Enter this program:

```
10 INPUT "WORD? "; A$
20 B = LEN (A$)
30 PRINT "WORD_IS_"; B; " LTRS"
40 END
```

_____ means space

Before you RUN the program notice several new features. Line 30 of this program exceeds the 16 character maximum of the PC-1245's display. When a line is longer than 16 characters (up to the 79 character maximum), PC-1245 moves the characters to the left as the 16 character maximum is exceeded. This does not destroy the previous input. This move to the left is referred to as horizontal scrolling.

The second new element in this program is the use of the END statement to signal the completion of a program. END tells the computer that the program is completed. It is always good programming practice to use an END statement.

As your programs get more complex you may wish to review them before you begin execution. To look at your program, use the LIST command. LIST, which can only be used in the PROgram mode, displays programs beginning with the lowest line number.

Try listing this program:

Input

LIST

Display

10: INPUT "WORD?"

Use the and arrows to move through your program until you have reviewed the entire program. To review a line which contains more than 16 characters move the cursor to the extreme right of the display and the additional characters will appear on the screen. After checking your program, run it:

Input

RUN

HELP

Display

WORD? _

WORD IS 4. LTRS

>

This is the end of your program. Of course you may begin it again by entering RUN. However, this program would be a bit more entertaining if it presented more than one opportunity for input. We will now modify the program so it will keep running without entering RUN after each answer.

Return to the PRO mode and use the up or down arrows (or LIST) to reach line 40.

You may type 40 to Delete the entire line or use the to position the cursor over the E in End. Change line 40 so that it reads:

40: GOTO 10

Now RUN the modified program.

The GOTO statement causes the program to loop (keep repeating the same operation). Since you put no limit on the loop it will keep going forever (an "infinite" loop). To stop this program hit the BREAK () key.

When you have stopped a program using the [BRK] key, you can restart it using the CONT command. CONT stands for CONTINUE. With the CONT command the program will restart on the line which was being executed when the [BRK] key was pressed.

Example 4 – More Complex Programming

The following program computes N Factorial (N!). The program begins with 1 and computes N! up to the limit which you enter. Enter this program.

```

100 F = 1: WAIT 128
110 INPUT "LIMIT? "; L
120 FOR N = 1 TO L
130 F = F * N
140 PRINT N, F
150 NEXT N
160 END

```

Several new features are contained in this program. The WAIT verb in line 100 controls the length of time that displays are held before the program continues. The numbers and their factorials are displayed as they are computed. The time they appear on the display is set by the WAIT statement to approximately 2 seconds, instead of waiting for you to press **ENTER**.

Also in line 100, notice that there are two statements on the same line separated by a colon (:). You may put as many statements as you wish on one line, separating each by a colon, up to the 80 character maximum including **ENTER**. Multiple statement lines can make a program hard to read and modify, however, so it is good programming practice to use them only where the statements are very simple or there is some special reason to want the statements on one line.

Also in this program we have used the FOR verb in line 120 and the NEXT verb in line 150 to create a loop. In Example 3 you created an "infinite" loop which kept repeating the statements inside the loop until you pressed the [BRK] key. With this FOR/NEXT loop the PC-1245 adds 1 to N each time execution reaches the NEXT verb. It then tests to see if N is larger than the limit L. If N is less than or equal to L, execution returns to the top of the loop and the statements are executed again. If N is greater than L, execution continues with line 160 and the program stops.

You may use any numeric variable in a FOR/NEXT loop. You also do not have to start counting at 1 and you can add any amount at each step. See Chapter 8 for details.

We have labelled this program with line numbers starting with 100. Labelling programs with different line numbers allows you to have several programs in memory at one time. To RUN this program instead of the one at line 10 enter:

RUN 100

In addition to executing different programs by giving their starting line number, you can give programs a letter name and start them with the DEF key (see Chapter 6).

You will notice that while the program is running, the BUSY indicator is lit at those times that there is nothing on the display. RUN the program a few more times and try setting N at several different values.

Storing Programs in the PC-1245's Memory

You will remember that settings, and functions remain in the computer even after it is turned OFF. Programs also remain in memory when you turn off the PC-1245, or it undergoes an AUTO OFF. Even if you use the **BRK**, **Clear** or **CA** keys the programs will remain.

Programs are lost from memory only when you perform the following actions:

- * You enter NEW before beginning programming.
- * You initialize the computer using the ALL RESET button.
- * You create a new program using the SAME LINE NUMBERS as a program already in memory.
- * You change the batteries.

This brief introduction to programming on the PC-1245 should serve to illustrate the exciting programming possibilities of your new computer.

The following table shows the number of bytes used to define each variable and the number used by each program statement.

Variable	Variable name	Data
Numeric array variable	6 bytes	8 bytes
String array variable	6 bytes	Specified number of bytes*

* For example, if DIM Z\$(2, 3) * 10 is specified, 12 variables, each capable of storing 10 characters, are reserved. This requires 6 bytes (variable name) + 10 bytes (number of characters) x 12 = 126 bytes.

Element	Line number	Statement & function	Others
Number of bytes used	2 bytes	1 byte	1 byte

Remaining Number of Bytes and Number of Usable Variables

The number of remaining bytes in the program/data area can be determined by operating:

MEM

To determine the number of numeric variables which can be reserved by the DIM statement use the following formula:

$(MEM - 6) / 8$

↑ When calculating the number of string variables, replace this "8" with the necessary number of characters.

CHAPTER 6 SHORTCUTS

The **PC-1245** includes several features which make programming more convenient by reducing the number of keystrokes required to enter repetitive material.

One such feature is in the availability of abbreviations for verbs and commands (See Chapter 8)

This chapter discusses the additional feature which can eliminate unnecessary typing — the DEF key.

The DEF Key and Labelled Programs

Often you will want to store several different programs in the **PC-1245's** memory at one time. (Remember that each must have unique line numbers). Normally, to start a program with a **RUN** or **GOTO** command, you need to remember the beginning line number of each program (see Chapter 8). But, there is an easier way! You can label each program with a letter and execute the program using only two keystrokes. This is how to label a program and execute it using **DEF**:

Note: Put a label on the first line of each program that you want to reference. The label consists of a single character in quotes, followed by a colon:

```
10: "A": PRINT "FIRST"
20: END
80: "B": PRINT "SECOND"
90: END
```

Any one of the following characters can be used: A, S, D, F, G, H, J, K, L, =, Z, X, C, V, B, N, M, and SPC. Notice that these are the keys in the last two rows of the alphabetic portion of the keyboard.

Note: To execute the program, instead of typing **RUN 80** or **GOTO 10**, you need only press the **DEF** key and then the letter used as a label. In the above example, pressing **DEF** and then 'B' would cause 'SECOND' to appear on the display.

When **DEF** is used to execute a program, variables and mode settings are affected in the same way as when **GOTO** is used. See Chapter 8 for details.

Template

One template is provided with the **PC-1245**. You can use this template to help you remember frequently used DEF key assignments. After you have labelled the programs, mark the template so you know what is associated with each key. You can then execute programs using the two-keystroke operation.

For example, if you have one group of programs which you often use at the same time, label the programs with letters and mark the template so that you can easily begin execution of any of the programs with two keystrokes.

Example:

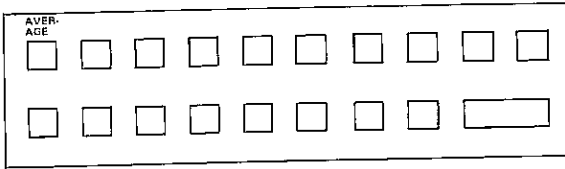

CHAPTER 7

USING THE CE-125 PRINTER/ MICROCASSETTE RECORDER

The CE-125 Printer/Microcassette Recorder allows you to add a printer and microcassette recorder to your SHARP PC-1245 Pocket Computer.

The CE-125 features:

- * 24 character wide thermal printer with approximately 48 line per minute print speed.
- * Convenient paper feed and tear bar.
- * Simultaneous printing of calculations as desired.
- * Easy control of display or printer output in BASIC.
- * Complete built-in microcassette playback/recorder unit including fast forward and tape counter.
- * Manual and program control of recorder for storing programs, data, and reserve key settings.
- * Filenames and passwords on tape for control and security.
- * Jack for external playback unit.
- * Built-in rechargeable Ni-Cad batteries for portability.
- * Recharger (EA-23E) supplied.
- * Automatic Stop Function of Microcassette when the end of tape is reached. (PLAY and RECORD modes only)

Introduction to the Machine

Before you begin to use the CE-125 you should first become familiar with its components. Let's examine the front of the machine:

The commands for the printer are only available on the optional printer/microcassette recorder CE-125.

Also, if the printing is executed when the printer switch of the CE-125 is set at OFF position, printing causes an error (ERROR code 8). In this case, turn the printer switch to ON position, and press the **CL** key. Then, execute the printing again.

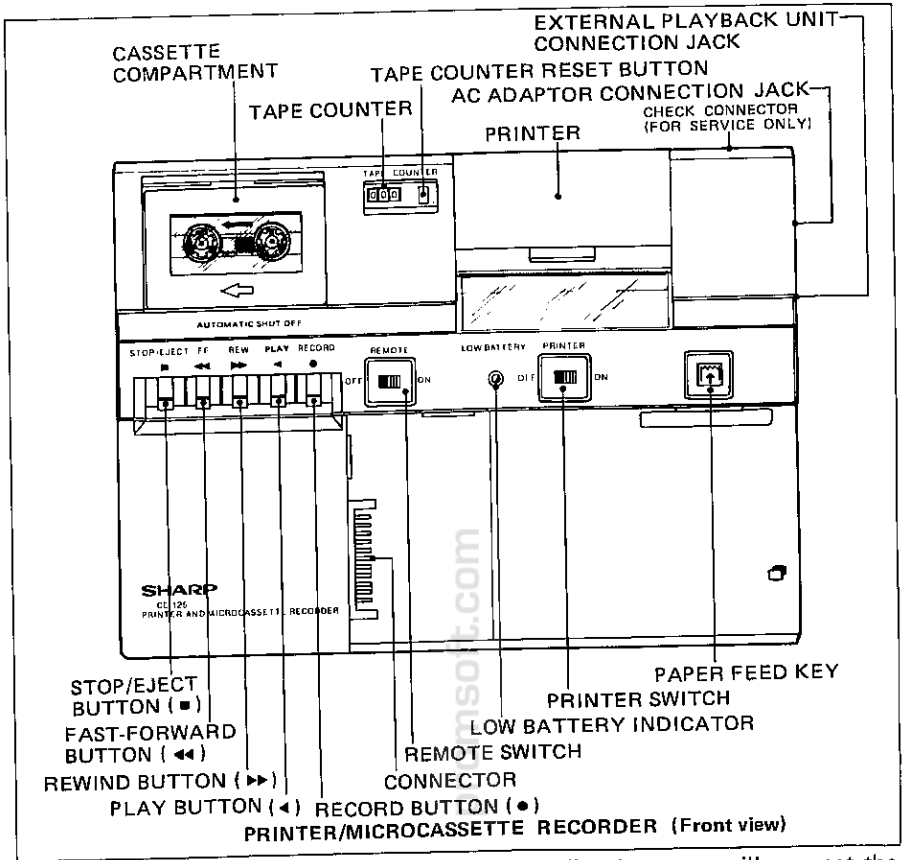

In the lower left corner of the machine is the cradle where you will connect the PC-1245 to the CE-125. The connector at the left end of this area will mate with the corresponding plug on the PC-1245. Notice the controls which run across the machine in the darkened strip. From left to right these are:

- * Microcassette recorder controls — STOP/EJECT, FF, REW, PLAY, and RECORD. These should be familiar from standard tape recorders.
- * REMOTE switch. This switch is used to operate the microcassette manually.
- * LOW BATTERY indicator. This indicates when there is insufficient power to operate the CE-125.
- * PRINTER ON/OFF. This switch is used to turn the printer on and off to conserve batteries when not in use.
- * Paper feed key. Pressing this key will feed the paper in the printer.

At the top edge of the machine, between the microcassette and the printer, is the tape counter.

Power

The CE-125 is powered by a rechargeable Ni-Cad battery. It is necessary to recharge the battery when the low battery indicator comes ON.

To recharge the battery, turn the computer and printer/recorder power OFF, connect the AC adaptor (EA-23E) to the printer/recorder, and plug the AC adaptor into a wall outlet. It will take about 15 hours before the battery is fully charged.

Important Note! Using any AC adaptor other than the one supplied (EA-23E) may damage the Printer/Recorder.

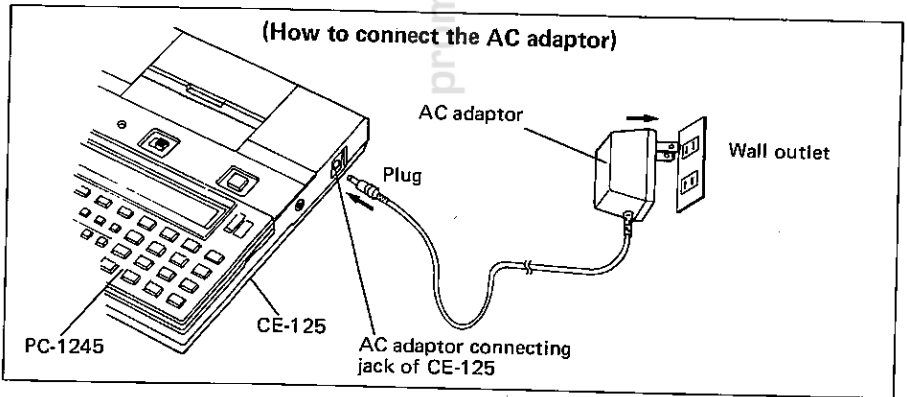
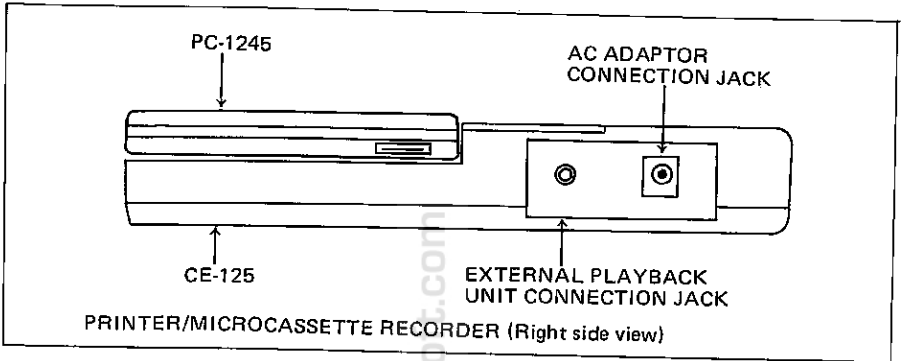

Always connect the recharger to the CE-125 first. Then plug the recharger into the wall socket.

When the batteries in the **CE-125** become discharged, the low battery indicator on the front of the unit lights up and the unit will not function. At this point you must recharge the batteries. When you first receive your **CE-125** it is likely that the batteries will have inadequate charge due to storage. The unit will require charging before its first use.

NOTE: When the computer is used with the **CE-125** and the battery power of the computer decrease, the power will be supplied to the computer from the **CE-125**.

Connecting the PC-1245 to the CE-125

To connect the **PC-1245** Pocket Computer to the **CE-125** Print/Microcassette Recorder use the following procedure:

1. Turn OFF the power in both units.

NOTE: It is important that the power be OFF on the **PC-1245** before connecting the units or the computer may "hang up". If this should occur use the ALL RESET button to clear the computer.

2. Place the upper edge of the computer into the "cradle" so that the Printer/Recorder guides match-up with the computer guide slots.
3. Lay the computer down flat.
4. Gently slide the computer to the left so that the pins on the Printer/Recorder are inserted into the plug on the computer.

DO NOT FORCE the computer and Printer/Recorder together. If the two parts do not mate easily, **STOP** and check to see that the parts are correctly aligned.

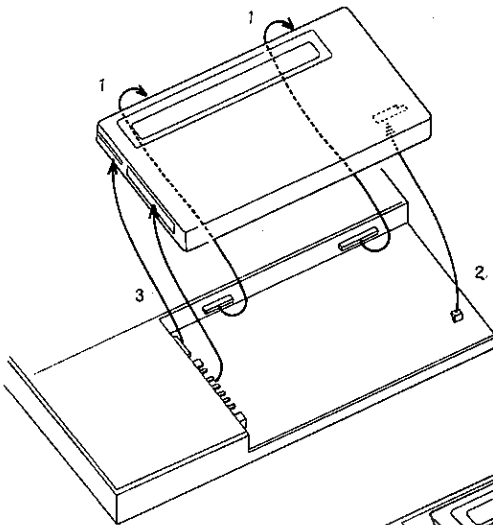

Fig. 1

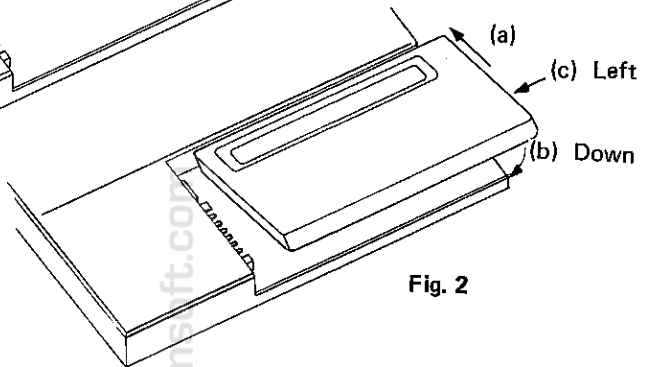

Fig. 2

5. To use the printer, turn on the PC-1245 and then the CE-125.

Press the **CL** key. If the **CL** key is not pressed, the printer may not operate.

Note: If executed when the printer switch is set at the OFF position, printing causes an error (ERROR code 8). (Low battery indicator may lit at the moment.)

In this case, turn the printer switch to ON position, and press the **CL** key. Then, execute the printing again.

Loading the Paper

- (1) Turn off the printer switch.
- (2) Open the paper cover. (Fig. 1)

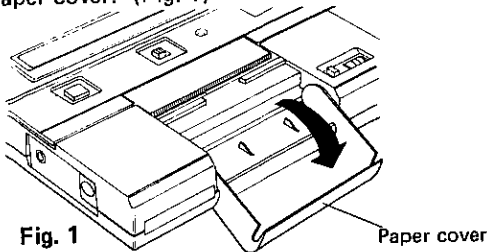

Fig. 1

Paper cover

- (3) Insert the leading edge of the roll of paper into the slot located in the paper tape compartment. (Fig. 2) (Fig. 3)
(Any curve or crease near the beginning of the paper makes insertion difficult.)

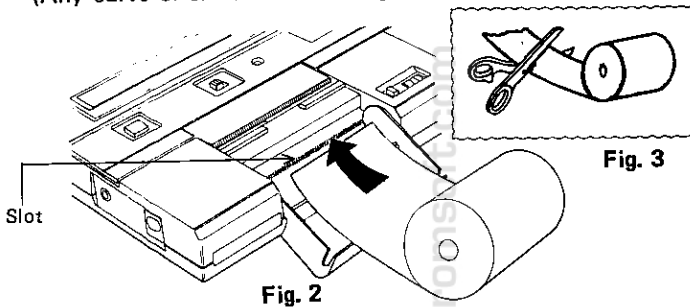

Fig. 2

Fig. 3

NOTE: Use of irregular paper tape may cause irregular paper feeding or paper misfeed. Therefore, be sure to tighten the roll before using as shown in the figure.

Paper tape roll



Wrong



Right

- (4) Turn on the printer switch and press the paper feed key until the paper comes out of the printer mechanism. (Fig. 4)

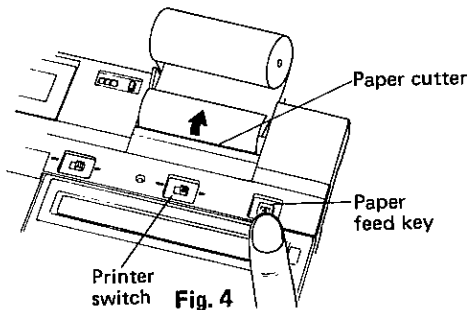

Printer switch Fig. 4

(5) Install the roll of paper into the compartment.

(6) Close the paper cover. (Fig. 5)

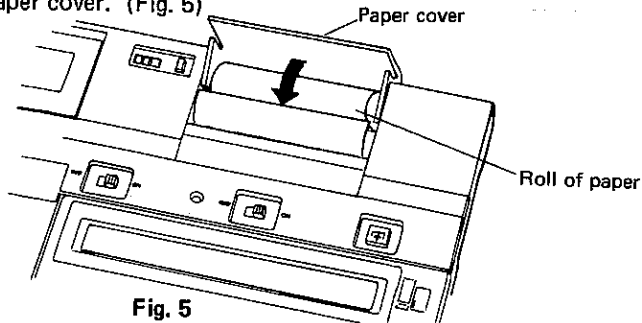

Fig. 5

- If it is necessary to remove the paper, cut the paper on the paper roll compartment side and pull the remaining paper through the printer in the direction of normal paper movement.

Do not pull the paper backwards as this may cause damage to printer mechanism.

CAUTION:

Paper tape is available wherever the CE-125 is sold.

Please order product No EA-1250P (5 rolls per package) when reordering the paper tape. The paper tape is specifically designed for this unique printer.

Use of any other paper tape may cause damage to the unit.

Using the Printer

If you are using the PC-1245 as a calculator, you may use the CE-125 to simultaneously print your calculations. This is easily accomplished by pressing the **SHIFT** key and then the **ENTER** key (P ↔ NP) while in the RUN mode. The printer indicator "P" will light up on the display. After this, when you press **ENTER** at the end of a calculation, the contents of the display will be printed on one line and the results will be printed on the next. For example:

Input

300 / 50

Paper

300 / 50
6.

You may print output on the printer from within BASIC programs by using the LPRINT statement (see Chapter 8 for details). LPRINT can be used in the same form as the PRINT statement. The difference is that if you PRINT something to the display which is longer than 16 characters, there is no way for you to see the extra characters. With the LPRINT verb, the extra characters will be printed on a second and possibly a third line as is required.

Programs which have been written with PRINT can be converted to work with the printer by including a PRINT=LPRINT statement in the program (see Chapter 8 for details). All PRINT statements following this statement will act as if they were LPRINT statements. PRINT=PRINT will reset this condition to its normal state. This structure may also be included in a program in an IF statement allowing a choice of output at the time the program is used.

You may also list your programs on the printer with the LLIST command (see Chapter 8 for details). If used without line numbers LLIST will list all program lines currently in memory in their numerical order by line number. A line number range may also be given with LLIST to limit the lines which will be printed. When program lines are longer than 24 characters, two or more lines may be used to print one program line. The second and succeeding lines will be indented four characters so that the line number will clearly identify each separate program line.

Caution:

- In case an error (ERROR code 8) occurs due to a paper misfeed, tear off the paper tape, and pull the remaining part of the paper tape completely out of the printer. Then press the **[CL]** key to clear the error condition.
- When the printer/recorder is exposed to strong external electrical noise, it may print numbers at random. If this happens, depress the **[BRK]** key to stop the printing, then press the **[CL]** key.

Pressing the **[CL]** key will return the printer to its normal condition.

When the printer causes a paper misfeed or is exposed to strong external electrical noise while printing, it may not operated normally and only the symbol "BUSY" is displayed. If this happens, depress the **[BRK]** key to stop the printing. (Release the paper misfeed.) Press the **[CL]** key.

- When the CE-125 is not in use, turn off the printer switch to save the battery life.
- Even while printing under the LPRINT command, the entry can be executed when an INPUT, INKEY\$ or PRINT command is performed.

In this case, however, the printer will stop if the **[CL]** key is pressed. Therefore, be sure to press the **[CL]** key upon completion of printing.

Using the Microcassette Recorder

LOADING THE CASSETTE TAPE

1. Depress the STOP/EJECT (■) button to open the cassette compartment lid.
2. Load the cassette tape into the compartment so that the title ("A" or "B") of the tape track to be used is facing upwards. The open edge of the cassette should be facing forward.
3. Press the cassette compartment lid down.

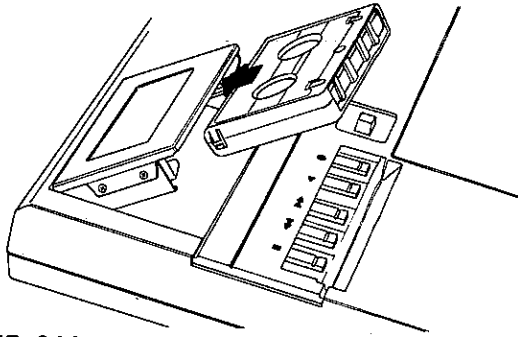

UNLOADING THE CASSETTE TAPE

1. Depress the STOP/EJECT (■) button to open the cassette compartment lid and remove the tape.
2. Press the cassette compartment lid down.

Note: In the PLAY mode press the STOP/EJECT (■) button once to stop the tape movement. Press it again to eject the tape.

Use the manual controls for positioning the tape. Set the 'REMOTE' switch to OFF. In this position you may use the fast forward (FF), and rewind (REW) buttons in combination with the tape counter to position the tape as desired. To return control of the cassette unit to the PC-1245, set the REMOTE switch to the ON position.

The facilities which are available with your cassette include:

- CSAVE Saves the contents of program or reserve memory on tape.
- CLOAD Retrieves a program or reserve memory from tape.
- CLOAD? Compares the program on tape with the contents of memory to insure that you have a good copy.
- MERGE Combines a program on tape with one already in memory.
- PRINT# Saves the contents of variables on tape.
- INPUT# Retrieves the contents of variables from tape.
- CHAIN Starts execution of a program which has been stored on tape.

Programs may be assigned filenames which will be stored on the tape. This allows the unambiguous storage of many programs on one tape. Programs can then be retrieved by name and the tape will be searched to find the appropriate file. If programs have been password protected in memory, they cannot be stored on tape, but a password can be assigned at the time that unprotected programs are CSAVED. Such password protected programs can be used by other persons, but they will not be able to LIST or modify the programs in any way.

See Chapter 8 for details on all these verbs and commands.

When a program or data is recorded on tape it will be preceded by a high pitched tone of approximately 7 seconds. This tone serves to advance the tape past any leader and to identify the beginning of each program or set of data.

When searching for a filename, the tape can read only in a forward direction. This search is relatively slow, so it is sometimes preferable to keep track of program locations by using the tape counter. The tape can then be manually positioned using fast forward, reverse, and play, to the leader tone area of the correct program before the retrieval is started. While scanning the tape you will be able to hear the high tones which begin each program. In between these high tones will be a mixed high and low tone sound which indicates programs or data.

Using an External Tape Playback Unit

The **CE-125** also provides a jack to connect an external tape playback unit. The external playback unit can only be used for **reading** from tape, i.e. **CLOAD**, **MERGE**, and **INPUT#**. The main purpose of this jack is to load tapes created on some other **SHARP** Pocket Computer.

Use the supplied cassette cable to connect the **CE-125** and an external tape playback unit.

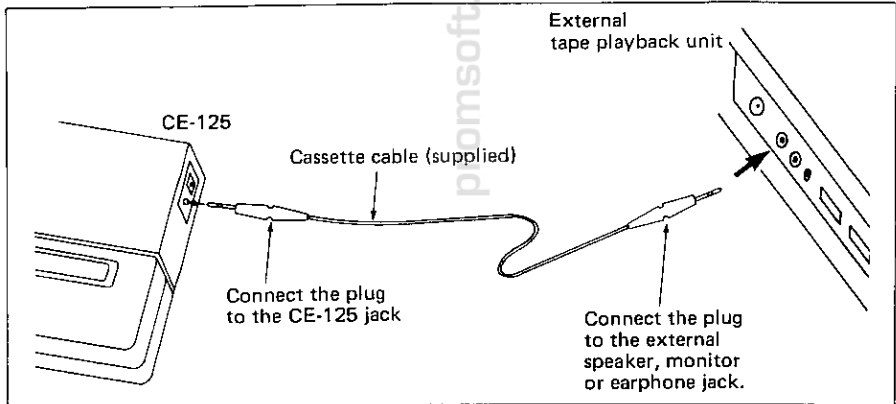

When the external tape unit is connected, it automatically takes the place of the internal microcassette for the appropriate commands and may be used in the same way.

- To transfer program and data from the tape of the external playback unit, use the tape recorder with which the tape was prerecorded. Other tape recorders may not work.

Care and Maintenance

- * Be sure that the power is OFF on both units when connecting or disconnecting the **CE-125** and the **PC-1245**.
- * The printer should be operated on a level surface.
- * The **CE-125** should be kept away from extreme temperatures, moisture, dust, and loud noises.
- * Use a soft, dry cloth to clean the **CE-125**. DO NOT use solvent or a wet cloth.
- * Keep foreign objects out of the **CE-125**.
- * Clean tape heads periodically with any standard head cleaning kit.

Errors

If the batteries become low, or if the **CE-125** is subjected to strong noise, the unit may cease to function and the **PC-1245** may "hang up". This can also occur if the units are connected and the power of the **CE-125** is not turned on when a LPRINT or LLIST command is used. In some cases ERROR 8 may be displayed on the **PC-1245**.

The CLear key usually clears this condition, but in some cases the ALL RESET may be required. Be sure to restore adequate power to the **CE-125** before attempting to use it again.

Examples

The procedures for the computer and the microcassette recorder operation

1. Saving

- (1) Turn off the REMOTE switch.
- (2) Put a tape into the tape compartment.
(Tape winding can be available by manual operation.)
- (3) Turn on the REMOTE switch.
- (4) Depress the **RECORD** (●) button.
- (5) With the same command which saves your program you must give the program a "filename". This is for reference purposes. Your filename can not be longer than 7 characters. To save the program with a filename type:

CSAVE **[SHIFT]** " PRO-1 **[SHIFT]** "

Your program will be saved with the name "PRO-1". You can assign any name you desire, whatever is easiest for you to keep trace of. Also, note that there is a 7 character length limit for your filename. If the name is

longer than 7 characters, the excess is ignored. A good practice is to maintain a program log, which includes the program name, starting and stopping location on tape (use the counter numbers), and a brief description of what the program does.

Press the **ENTER** key. At this time you should hear a shrill buzzing sound, and the tape should be turning. Also the "BUSY" indicator should light up. This tells you that the computer is "busy" transferring your program from memory to the tape. If this does not happen, start again from the beginning of the section.

Once the computer arrives at the end of the program, the "BUSY" indicator light will go off, the recorder will stop, and the "prompt" will re-appear on the display. In order to insure that this has in fact been accomplished we can read it back into memory from the tape as explained in the next section.

Note: When saving a program on the used tape, erase the portion (approx. 5 counter numbers) before writing and execute the recording command.

(Make sure that the previous program is completely erased without any portion remaining.)

2. Collating the Computer and Tape Contents

Now that your program is saved on tape, you will no doubt want to see if it is really there. To do this is relatively simple; use the CLOAD? command.

- (1) Turn off the REMOTE switch to clear remote control functions.
- (2) Rewind the tape to the place at which you started, again using the number counter.
- (3) Turn on the REMOTE switch to set remote control functions.
- (4) Depress the **PLAY** { **◀** } button.
- (5) To collate the program with a filename type:

CLOAD **SHIFT** ? **SHIFT** " PRO-1 **SHIFT** "

Press the **ENTER** key.

During the collation, the mark "*" is shown at the right most digit of the display. The mark "*" will disappear when the collation is completed. While a file name is being retrieved, no "*" mark will be displayed as the collation is not started yet. This is the same for the MERGE, CHAIN, CLOAD, and INPUT# commands. (The same occurs when the first program is read without a file name.)

Note 1) If the specified file name is not found, the computer will continue to retrieve the file name even after the tape stops. In such a case, press **BRK** to stop retrieval. This is the same for the MERGE, CHAIN, CLOAD, and INPUT# commands.

The computer compares the CSAVED program with the one in its memory. If all went well, it will display the "prompt" and end its check. If all did not go well, an error message will be displayed, usually ERROR 8. This tells you that the program on tape is somehow different from the program in SHARP's memory. Erase that portion of tape and start again.

3. Transfer from Tape

- (1) Turn off the REMOTE switch.
- (2) Rewind the tape to the place at which you started, again using the number counter.
- (3) Stop rewinding.
- (4) Turn the REMOTE switch back ON.
- (5) Press the PLAY (◀) button.
- (6) Type:

CLOAD SHIFT "PRO-1 SHIFT "

and press the ENTER key.

(Remember "PRO-1" is the filename we have given to your program. If you saved the program under another name you must use that name instead of PRO-1)

- (7) The mark "*" appears while loading the designated CSAVED program from the tape to the computer's memory.
(The same occurs when the first program is read without a file name.)
The mark "*" disappears when the load is performed completely.
- (8) The cassette retains a copy of the program, so you can CLOAD the same program over and over again.
While loading, when an error message ERROR 8 is displayed, start again from the above step (1).

CHAPTER 8

BASIC REFERENCE

The following chapter is divided into three sections:

- Commands:** Instructions which are used outside a program to change the working environment, perform utilities, or control programs.
- Verbs:** Action words used in programs to construct BASIC statements.
- Functions:** Special operators used in BASIC programs to change one variable into another.

Commands and verbs are arranged alphabetically. Each entry is on a separate page for easy reference. The contents of each section is shown in the tables below so that you can quickly identify the category to which an operator belongs. Functions are grouped according to four categories and arranged alphabetically within category.

Commands

Program Control

CONT
GOTO*
NEW
RUN

Cassette Control

CLOAD
CLOAD?
CSAVE
INPUT #*
MERGE
PRINT #*

Debugging

LIST
LLIST
TROFF*
TRON*

Variables Control

CLEAR
DIM*

Angle Mode Control

DEGREE*
GRAD*
RADIAN*

Other

BEEP*
PASS*
RANDOM*
USING*
WAIT*

*These commands are also BASIC verbs. Their effect as commands is identical to their effect as verbs so they are not described in the command reference section. See the verb reference section for more information.

Verbs

Control and Branching

CHAIN
END
FOR ... TO ... STEP
GOSUB
GOTO
IF ... THEN
NEXT
ON ... GOSUB
ON ... GOTO
RETURN
STOP

Assignment and Declaration

CLEAR
DIM
LET

Input and Output

AREAD
CSAVE
DATA
INPUT
INPUT #
LPRINT
PAUSE
PRINT
PRINT #
USING
READ
RESTORE
WAIT

Other

BEEP
DEGREE
GRAD
RADIAN
RANDOM
REM
TROFF
TRON

promsoft.com

FunctionsPseudovariables

INKEY\$
MEM
PI

String Functions

ASC
CHR\$
LEFT\$
LEN
MID\$
RIGHT\$
STR\$
VAL

Numeric Functions

ABS
ACS
ASN
ATN
COS
DEG
DMS
EXP
INT
LOG
LN
RND
SGN
SIN
SQR
TAN

COMMANDS

- 1 CLOAD
- 2 CLOAD "filename"

Abbreviations: CLO., CLOA.

See also: CLOAD?, CSAVE, MERGE, PASS

Purpose

The CLOAD command is used to load a program saved on cassette tape. It can only be used with the optional CE-125 Printer/Microcassette Recorder.

Use

The first form of the CLOAD command clears the memory of existing programs and loads the first program stored on the tape, starting at the current position.

The second form of the CLOAD command clears the memory, searches the tape for the program whose name is given by "filename", and loads the program.

If the PC-1245 is in PROgram or RUN mode, program memory is loaded from the tape.

Examples

CLOAD Loads the first program from the tape.

CLOAD "PRO3" Searches the tape for the program named 'PRO3' and loads it.

Notes:

1. If the designated file name is not retrieved, the computer will continue to search the file name even after the tape reaches the end. In this case, stop the retrieval function by pressing the ^{ON}BRK key. This applies to MERGE, CHAIN, CLOAD? and INPUT# commands to be described later.
2. If an error occurs during CLOAD or CHAIN command (to be described later) execution, the program stored in the computer will be invalid.

- 1 CLOAD?
- 2 CLOAD? "filename"

Abbreviations: CLO.?, CLOA.?

See also: CLOAD, CSAVE, MERGE, PASS

Purpose

The CLOAD? command is used to compare a program saved on cassette tape with one stored in memory. It can only be used with the optional CE-125 Printer/Microcassette Recorder.

Use

The first form of the CLOAD? command compares the program stored in memory with the first program stored on the tape, starting at the current position.

The second form of the CLOAD? command searches the tape for the program whose name is given by "filename" and then compares it to the program stored in memory.

Examples

CLOAD?

Compares the first program from the tape with the one in memory.

CLOAD? "PRO3"

Searches the tape for the program named 'PRO3' and compares it to the one stored in memory.

1 CONT

Abbreviations: C., CO., CON.

See also: RUN, STOP verb

Purpose

The CONT command is used to continue a program which has been temporarily halted.

Use

When the STOP verb is used to halt a program during execution, the program can be continued by entering CONT in response to the prompt.

When a program is halted using the **[BRK]** key, the program can be continued by entering CONT in response to the prompt.

Examples

CONT Continues an interrupted program execution.

- 1 CSAVE
- 2 CSAVE "filename"
- 3 CSAVE , "password"
- 4 CSAVE "filename", "password"

Abbreviations: CS., CSA., CSAV.

See also: CLOAD, CLOAD?, MERGE, PASS

Purpose

The CSAVE command is used to save a program to cassette tape. It can only be used with the optional **CE-125** Printer/Microcassette Recorder.

Use

The first form of the CSAVE command writes all of the programs in memory on to the cassette tape without a specified file name.

The second form of the CSAVE command writes all of the programs in memory on to the cassette tape and assigns the indicated file name.

The third form of the CSAVE command writes all of the programs in memory on to the cassette tape without a specified file name and assigns the indicated password. Programs saved with a password may be loaded by anyone, but only someone who knows the password can list or modify the programs. (See discussion under PASS command).

The fourth form of the CSAVE command writes all of the programs in memory on to the cassette tape and assign them the indicated file name and password.

If the **PC-1245** is in PROgram or RUN mode, program memory is loaded to the tape.

Examples

CSAVE "PRO3", "SECRET" Saves the programs now in memory on to the tape under the name 'PRO3', protected with the password 'SECRET'.

1 **GOTO** expression

Abbreviations: G., GO., GOT.

See also: RUN

Purpose

The GOTO command is used to start execution of a program.

Use

The GOTO command can be used in place of the RUN command to start program execution at the line number specified by the expression.

GOTO differs from RUN in five respects:

- 1) The value of the interval for WAIT is not reset.
- 2) The display format established by USING statements is not cleared.
- 3) Variables and arrays are preserved.
- 4) PRINT = LPRINT status is not reset.
- 5) The pointer for READ is not reset.

Execution of a program with GOTO is identical to execution with the **DEF** key.

Examples

GOTO 100

Begins execution of the program at line 100.

1 LIST

2 LIST expression

Abbreviations: L., LI., LIS.

See also: LLIST

Purpose

The LIST command is used to display a program.

Use

The LIST command may only be used in the PROgram mode. The first form of the LIST command displays the statement with the lowest line number.

The second form displays the statement with the nearest line number greater than the value of the expression. The Up Arrow and Down Arrow keys may then be used to examine the program.

Examples

LIST 100

Displays line number 100.

1 LLIST

2 LLIST expression 1 , expression 2

Abbreviations: LL., LLI., LLIS.

See also: LIST

Purpose

The LLIST command is used for printing a program on the optional **CE-125** Printer/Microcassette Recorder.

Use

The LLIST command may only be used in the **PRO**gram mode.

The first form prints all of the programs in memory.

The second form prints the statements from the line number with the nearest line equal to or greater than the value of expression 1 to the nearest line equal to or greater than the value of expression 2. There must be at least two lines between the two numbers.

Examples

LLIST 100, 200 Lists the statements between line numbers 100 and 200.

- 1 MERGE
- 2 MERGE "filename"

Abbreviations: MER., MERG.

See also: CLOAD, CLOAD?, CSAVE, PASS verb

Purpose

The MERGE command is used to load a program saved on cassette tape and merge it with programs existing in memory. It can only be used with the optional CE-125 Printer/Microcassette Recorder.

Use

The first form of the MERGE command loads the first program stored on the tape starting at the current position and merges it with programs already in memory.

The second form of the MERGE command searches the tape for the program whose name is given by "filename", and merges it with the programs already in memory.

Programs with overlapping line numbers are treated as one program after merging.

If the program in memory is password protected, another password protected program cannot be merged with it. If the program on cassette is not password protected, it becomes protected by the password of the program in memory when merged.

If the program in memory is not password protected, it becomes protected by the password of the program on the cassette when merged.

Examples

MERGE

Merges the first program from the tape.

MERGE "PRO3"

Searches the tape for the program named 'PRO3' and merges it.

Note: For example, let's assume the computer memory contains the following program:

```
10: PRINT "DEPRECIATION"  
20: INPUT "METHOD: " ; A
```

Commands
MERGE

At this point you remember that you have a similar program portion on tape under the filename "DEP1". You will, of course, want to see if this program has sections useful in the program you are currently constructing. The first step is to find the tape with "DEP1" on it. Cue the tape to the place at which "DEP1" starts.

Now type: MERGE "DEP1" and press **ENTER**.

The computer will now load "DEP1" into memory IN ADDITION to the above program. After "DEP1" is loaded, you might find something in memory similar to this:

```
10: PRINT "DEPRECIATION"  
20: INPUT "METHOD: " ; A  
10: "DEP1" : REM >> SECOND MODULE <<  
20: PRINT "INTEREST CHARGES"  
30: INPUT "AMT. BORROWED: " ; B  
:  
(etc)
```

Note that unlike the CLOAD command, the new program DID NOT replace the existing one and that some line numbers have been duplicated. Also note that a "label" was used on the first line of the merged module. This allows "LINKING" of the modules together (See LINKING MERGED MODULES - below). It is important that you review the following information before proceeding with any further editing or programming:

IMPORTANT NOTES:

Once a MERGE is performed, no INSERTIONS DELETIONS, or CHANGES are allowed to previously existing program lines.

Example:

```
10 "A" REM THIS IS EXISTING PROGRAM  
20 FOR T = 1 TO 100  
30 LPRINT T  
40 NEXT T  
:  
(etc)
```

BEFORE doing a MERGE of the next program, make any necessary changes to this program.

Then MERGE the next program: MERGE "PROG2" (example)

```
10 "B" REM THIS IS MERGED PROGRAM
20 INPUT "ENTER DEPRECIATION: " ; D
30 INPUT "NUMBER OF YEARS: " ; Y
40   etc.
```

Now you may make changes to the above program since it was the last MERGED portion.

LINKING MERGED MODULES (programs) TOGETHER

Since the processor executes your program lines in logical sequence, it will stop when it encounters a break in the sequence in line numbering, i.e. if line numbers 10, 20, 30 are followed by duplicate line numbers in a second module, the following techniques are valid: GOTO "B" GOSUB "B", IF. . . THEN "B" (B is used for example only, you can use any label.

Commands
NEW

1 **NEW**

Abbreviations: none

Purpose

The NEW command is used to clear existing program.

Use

When used in the PROgram mode the NEW command clears all programs and data which are currently in memory. (The programs with password cannot be cleared.)

The NEW command is not defined in the RUN mode and will result in an ERROR 9.

Examples

NEW

Clears program or data.

promsoft.com

1 PASS "character string"

Abbreviations: PA., PAS.

See also: CSAVE, CLOAD

Purpose

The PASS command is used to set and cancel passwords.

Use

Passwords are used to protect programs from inspection or modification by other users. A password consists of a character string which is **no more than seven characters long**. The seven characters must be alphabetic or one of the following special symbols: ! # \$ % & () * + - / . : ; < = > ? @ $\sqrt{\quad}$ π ^

Once a PASS command has been given the programs in memory are protected. A password protected program cannot be examined or modified in memory. It cannot be output to tape or listed with LIST or LLIST, nor is it possible to add or delete program lines. If several programs are in memory and PASS is entered, all programs in memory are protected. If a non-password protected program is merged with a protected program, the merged program is protected. The only way to remove this protection is to execute another PASS command with the same password.

Examples

PASS "SECRET" Establishes the password 'SECRET' for all programs in memory.

1 RUN

2 RUN line number

Abbreviations: R., RU.

See also: GOTO

Purpose

The RUN command is used to execute a program in memory.

Use

The first form of the RUN command executes a program beginning with the lowest numbered statement in memory.

The second form of the RUN command executes a program beginning with the specified line number.

RUN differs from GOTO in five respects:

- 1) The value of the interval for WAIT is reset.
- 2) The display format established by USING statements is cleared.
- 3) Variables and arrays other than the fixed variables are cleared.
- 4) PRINT = PRINT status is set.
- 5) The pointer for READ is reset to the beginning DATA statement.

Execution of a program with GOTO is identical to execution with the DEF key. In all three forms of program execution FOR/NEXT and GOSUB nesting is cleared.

Examples

RUN 100

Executes the program which begins at line number 100.

VERBS

1 AREAD variable name

Abbreviations: A., AR., ARE., AREA.

See also: INPUT verb and discussion of the use of the DEF key in Chapter 6

Purpose

The AREAD verb is used to read in a single value to a program which is started using the **DEF** key.

Use

When a program is labelled with a letter, so that it can be started using the **DEF** key, the AREAD verb can be used to enter a single starting value without the use of the INPUT verb. The AREAD verb must appear on the first line of the program following the label. If it appears elsewhere in the program, it will be ignored. Either a numeric or string variable may be used, but only one can be used per program.

To use the AREAD verb type the desired value in the RUN mode, press the **DEF** key, followed by the letter which identifies the program. If a string variable is being used, it is not necessary to enclose the entered string in quotes.

Examples

```
10 "X": AREAD N
20 PRINT N ^ 2
30 END
```

Entering "7 **DEF** X" will produce a display of "49".

Notes:

1. When the display indicates PROMPT (">") at the start of program execution, the designated variable is cleared.
2. When the contents is displayed by PRINT verb at the start of program execution, the following is stored:

Verbs BEEP

- When the display indicates PRINT numeric expression, numeric expression or PRINT "String", "String", the contents on the right of the display are stored.

Example: When the program below is executed;

```
10 "A" : PRINT "ABC", "DEFG"  
20 "S" : AREAD A$ : PRINT A$  
RUN mode
```

```
DEF A → ABC DEFG
```

```
DEF S → DEFG
```

- When the display indicates PRINT Numeric expression; Numeric expression; Numeric expression..., the contents displayed first (on the extreme left) are stored.
- When the display indicates PRINT "String"; "String"; "String"..., the "String" designated last are stored.

1 BEEP expression

Abbreviations: B., BE., BEE.

Purpose

The BEEP verb is used to produce an audible tone.

Use

The BEEP verb causes the PC-1245 to emit one or more audible tones at 4 kHz. The number of beeps is determined by the expression, which must be numeric. The expression is evaluated, but only the integer part is used to determine the number of beeps.

BEEP may also be used as a command using numeric literals and predefined variables. In this case the beeps occur immediately after the **ENTER** key is pressed.

Examples

- ```
10 A = 5 : A$ = "9"
20 BEEP 3 Produces 3 beeps.
30 BEEP A Produces 5 beeps.
40 BEEP (A+4)/2 Produces 4 beeps.
50 BEEP A$ This is illegal and will produce an ERROR 9 message.
60 BEEP -4 Produces no beeps, but does not produce an error message.
```

- 1 CHAIN
- 2 CHAIN expression
- 3 CHAIN "filename"
- 4 CHAIN "filename", expression

Abbreviations: CH., CHA., CHAI.

See also: CLOAD, CSAVE, and RUN

## Purpose

The CHAIN verb is used to start execution of a program which has been stored on cassette tape. It can only be used in connection with the optional CE-125 Printer/Microcassette Recorder.

## Use

To use the CHAIN verb one or more programs must be stored on a cassette. Then, when the CHAIN verb is encountered in a running program, a program is loaded from the cassette and executed.

The first form of CHAIN loads the first program stored on the tape and begins execution with the lowest line number in the program. The effect is the same as having entered CLOAD and RUN when in the RUN mode.

The second form of CHAIN loads the first program stored on the tape and begins execution with the line number specified by the expression.

The third form of CHAIN searches the tape for the program whose name is indicated by "filename", loads the program, and begins execution with the lowest line number.

The fourth form of CHAIN will search the tape for the program whose name is indicated by filename, load the program, and begin execution with the line number indicated by the expression.

## Examples

10 CHAIN

Loads the first program from the tape and begins execution with the lowest line number.

20 CHAIN "PRO-2", 480

Searches the tape for a program named PRO-2, loads it, and begins execution with line number 480.





## 1 CLEAR

Abbreviations: CL., CLE., CLEA.

See also: DIM

### Purpose

The CLEAR verb is used to erase all variables which have been used in the program and to reset all preallocated variables to zero or NUL.

### Use

The CLEAR verb recovers space which is being used to store variables. This might be done when the variables used in the first part of a program are not required in the second part and available space is limited. CLEAR may also be used at the beginning of a program when several programs are resident in memory and you want to clear out the space used by execution of prior programs.

CLEAR does not free up the space used by the variables A – Z, A\$ – Z\$, or A(1) – A(26) since they are permanently assigned (see Chapter 4). CLEAR does reset numeric variables to zero and string variables to NUL.

### Examples

```
10 A = 5 : DIM C(5)
```

```
20 CLEAR
```

Frees up the space assigned to C( ) and resets A to zero.

## 1 DEGREE

Abbreviations: DE., DEG., DEGR., DEGRE.

See also: GRAD and RADIAN

### Purpose

The DEGREE verb is used to change the form of angular values to decimal degrees.

### Use

The PC-1245 has three forms for representing angular values – decimal degrees, radians and gradient. These forms are used in specifying the arguments to the SIN, COS, and TAN functions and in returning the results from the ASN, ACS, and ATN functions.

The DEGREE function changes the form for all angular values to decimal degree from until a GRAD or RADIAN verb is used. The DMS and DEG functions can be used to convert decimal degrees to degree, minute, second form and vice versa.

### Examples

10 DEGREE

20 X = ASN 1

X now has a value of 90, i.e. 90 degrees, the Arcsine of 1.

**1 DATA expression list**

Where: expression list is: expression  
or: expression , expression list

Abbreviations: DA., DAT.

See also: READ, RESTORE

**Purpose**

The DATA verb is used to provide values for use by the READ verb.

**Use**

When assigning initial values to an array, it is convenient to list the values in a DATA statement and use a READ statement in a FOR . . . NEXT loop to load the values into the array. When the first READ is executed, the first value in the first DATA statement is returned. Succeeding READs use succeeding values in the sequential order in which they appear in the program, regardless of how many values are listed in each DATA statement or how many DATA statements are used.

DATA statements have no effect if encountered in the course of regular execution of the program, so they can be inserted wherever it seems appropriate. Many programmers like to include them immediately following the READ which uses them. If desired, the values in a DATA statement can be read a second time by using the RESTORE statement.

**Examples**

|                          |                                                      |
|--------------------------|------------------------------------------------------|
| 10 DIM B(10)             | Sets up an array.                                    |
| 20 FOR I = 1 TO 10       |                                                      |
| 30 READ B(I)             | Loads the values from the DATA statement into B( )   |
| 40 NEXT I                | B(1) will be 1, B(2) will be 2, B(3) will be 3, etc. |
| 50 DATA 1, 2, 3, 4, 5, 6 |                                                      |
| 70 DATA 7, 8, 9, 10      |                                                      |

1 DIM dim list

|        |                         |     |                                         |
|--------|-------------------------|-----|-----------------------------------------|
| Where: | <u>dim list</u>         | is: | <u>dimension spec.</u>                  |
|        |                         | or: | <u>dimension spec. , dim list</u>       |
| and:   | <u>dimension spec.</u>  | is: | <u>numeric dim spec.</u>                |
|        |                         | or: | <u>string dim spec.</u>                 |
| and:   | <u>numeric dim spec</u> | is: | <u>numeric name (size)</u>              |
| and:   | <u>string dim spec</u>  | is: | <u>string name (dims)</u>               |
|        |                         | or: | <u>string name (dims) * len</u>         |
| and:   | <u>numeric name</u>     | is: | valid numeric variable name             |
| and:   | <u>string name</u>      | is: | valid string variable name              |
| and:   | <u>dims</u>             | is: | <u>size</u>                             |
|        |                         | or: | <u>size, size</u>                       |
| and:   | <u>size</u>             | is: | number of elements                      |
| and:   | <u>len</u>              | is: | length of each string in a string array |

Abbreviations: D., DI.

**Purpose**

The DIM verb is used to reserve space for numeric and string variables.

**Use**

Except for A(1) ~ A(26) and A\$(1) ~ A\$(26), which are predefined (see Chapter 4), a DIM verb must be used to reserve space for any array variable. An array variable and a simple variable may not have the same name. A string array and a numeric array may have the same name except for the dollar sign.

The maximum number of dimensions in any array is two; the maximum size of any one dimension is 255. In addition to the number of elements specified in the dimension statement, one additional "zeroeth" element is reserved. For example, DIM B(3) reserves B(0), B(1), B(2), and B(3). In two dimensional arrays there is an extra "zeroeth" row and column.

In string arrays one specifies the size of each string element in addition to the number of elements. For example, DIM B\$(3)\*12 reserves space for 4 strings which are each a maximum of 12 characters long. If the length is not specified each string can contain a maximum of 16 characters.

When a numeric array is dimensioned, all values are initially set to zero; in a string array the values are set to NUL.

A( ) and A\$( ) may be dimensioned to sizes larger than 26 with the DIM statement. In this case, part of the array is in the preallocated memory and part is in program memory. See Chapter 4.

### Examples

- 10 DIM B(10) Reserves space for a numeric array with 11 elements.
- 20 DIM C\$(4, 4)\*10 Reserves space for a two dimensional string array with 5 rows and 5 columns; each string will be a maximum of 10 characters.

### NOTE:

The PC-1245 makes it possible to use an expression as the suffix of two-dimensional string array variables.

For the second suffix, however, do not use a DIM statement. However, arrays, such as A(30) can be used with this.

Example 1: B (A\*B, C (0)) = 10. . . . . Not usable

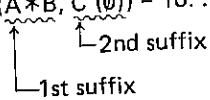

Example 2: B (C (0), 5) = 10. . . . . Usable

Example 3: B (4, A(30)) = 10. . . . . Usable

In Example 1, therefore, C (0) can be used when replaced by A(30), or if required, A(30) = C (0) is placed before it.

Verbs  
END

1 END

Abbreviations: E., EN.

### Purpose

The END verb is used to signal the end of a program.

### Use

When multiple programs are loaded into memory at the same time a mark must be included to indicate where each program ends so that execution does not continue from one program to another. This is done by including an END verb as the last statement in the program.

### Examples

10 PRINT "HELLO"

20 END

30 PRINT "GOODBYE"

40 END

With these programs in memory a 'RUN 10' prints 'HELLO', but not 'GOODBYE'. 'RUN 30' prints 'GOODBYE'.

promsoft.com

```

1 FOR numeric variable = expression 1 TO expression 2
2 FOR numeric variable = expression 1 TO expression 2
 STEP expression 3

```

Abbreviations: F. and FO.; STE.

See also: NEXT

### Purpose

The FOR verb is used in combination with the NEXT verb to repeat a series of operations a specified number of times.

### Use

The FOR and the NEXT verbs are used in pairs to enclose a group of statements which are to be repeated. The first time this group of statements is executed the loop variable (the variable named immediately following the FOR) has the value of expression 1.

When execution reaches the NEXT verb this value is tested against expression 2. If the value of the loop variable is less than expression 2, the loop variable is increased by the step size and the enclosed group of statements is executed again, starting with the statement following the FOR. In the first form the step size is 1; in the second form the step size is given by expression 3. If the value of the loop variable is greater than or equal to expression 2, execution continues with the statement which immediately follows the NEXT. Because the comparison is made at the end, the statements within a FOR/NEXT pair are always executed at least once.

Expression 1 may have any value in the numeric range. When expression 1 and expression 2 are compared, only the integer part is used in the expression 2. Expression 2 and expression 3 must be an integer in the range of  $-32768$  to  $32767$ ; Expression 3 may not be zero.

Expression 1, expression 2 and expression 3 can also be specified in negative.

The loop variable may be used within the group of statements, for example as an index to an array, but care should be taken in changing the value of the loop variable.

Programs should be written so that they never jump from outside a FOR/NEXT pair to a statement within a FOR/NEXT pair. Similarly, programs must never leave a FOR/NEXT pair by jumping out. Always exit a FOR/NEXT loop via the NEXT statement. To do this, set the loop variable to a value higher than expression 2.

**Verbs  
FOR**

The group of statements enclosed by a FOR/NEXT pair can include another pair of FOR/NEXT statements which use a different loop variable as long as the enclosed pair is completely enclosed; i.e., if a FOR statement is included in the group, the matching NEXT must also be included. FOR/NEXT pairs may be "nested" up to five levels deep.

**Examples**

```
10 FOR I = 1 TO 5
20 PRINT I
30 NEXT I
```



This group of statements prints the numbers 1, 2, 3, 4, 5.

```
40 FOR N = 10 TO 0 STEP -1
50 PRINT N
60 NEXT N
```



This group of statements counts down 10, 9, 8, 7, 6, 5, 4, 3, 2, 1, 0.

```
70 FOR N = 1 TO 10
80 X = 1
90 FOR F = 1 TO N
100 X = X * F
110 NEXT F
120 PRINT X
130 NEXT N
```



This group of statements computes and prints N factorial for the numbers from 1 to 10.

promsoft.com



**1 GOSUB expression**

Abbreviations: GOS., GOSU.

See also: GOTO, ON . . . GOSUB, ON . . . GOTO, RETURN

**Purpose**

The GOSUB verb is used to execute a BASIC subroutine.

**Use**

When you wish to execute the same group of statements several times in the course of a program or use a previously written set of statements in several programs, it is convenient to use the BASIC capability for subroutines using the GOSUB and RETURN verbs.

The group of statements is included in the program at some location where they are not reached in the normal sequence of execution. A frequent location is following the END statement which marks the end of the main program. At those locations in the main body of the program — where subroutines are to be executed, include a GOSUB statement with an expression which indicates the starting line number of the subroutine. The last line of the subroutine must be a RETURN. When GOSUB is executed, the **PC-1245** transfers control to the indicated line number and processes the statements until a RETURN is reached. Control is then transferred back to the statement following the GOSUB.

A subroutine may include a GOSUB. Subroutines may be “nested” in this fashion up to 10 levels deep.

The expression in a GOSUB statement may not include a comma, e.g., ‘A(1, 2)’ cannot be used. Since there is an ON . . . GOSUB structure for choosing different subroutines at given locations in the program, the expression usually consists of just the desired line number. When a numeric expression is used it must evaluate to a valid line number, i.e., 1 to 999, or an ERROR 4 will occur.

**Examples**

```
10 GOSUB 100
20 END
100 PRINT "HELLO"
110 RETURN
```

When this program is run it prints the word ‘HELLO’ one time.

1 **GOTO** expression

Abbreviations: G., GO., GOT.

See also: GOSUB, ON ... GOSUB, ON ... GOTO

**Purpose**

The GOTO verb is used to transfer control to a specified line number.

**Use**

The GOTO verb transfers control from one location in a BASIC program to another location. Unlike the GOSUB verb, GOTO does not "remember" the location from which the transfer occurred.

The expression in a GOTO statement may not include a comma, e.g., 'A(1, 2)' cannot be used. Since there is an ON ... GOTO structure for choosing different destinations at given locations in the program, the expression usually consists of just the desired line number. When a numeric expression is used, it must evaluate to a valid line number, i.e., 1 to 999, or an ERROR 4 will occur.

Well designed programs usually flow simply from beginning to end, except for sub-routines executed during the program. Therefore, the principal use of the GOTO verb is as a part of an IF ... THEN statement.

**Examples**

```
10 INPUT A$
20 IF A$ = "Y" THEN GOTO 50
30 PRINT "NO"
40 GOTO 60
50 PRINT "YES"
60 END
```

This program prints 'YES' if a 'Y' is entered and prints 'NO' if anything else is entered.

**1 GRAD**

Abbreviations: GR., GRA.

See also: DEGREE and RADIAN

**Purpose**

The GRAD verb is used to change the form of angular values to gradient form.

**Use**

The PC-1245 has three forms for representing angular values — decimal degrees, radians, and gradient. These forms are used in specifying the arguments to the SIN, COS, and TAN functions and in returning the results from the ASN, ACS, and ATN functions.

The GRAD function changes the form for all angular values to gradient form until a DEGREE or RADIAN verb is used. Gradient form represents angular measurement in terms of percent gradient, i.e., a  $45^\circ$  angle is a  $59^g$  gradient.

**Examples**

10 GRAD

20 X = ASN 1

X now has a value of 100, i.e., a  $100^g$  gradient, the Arcsine of 1.

## Verbs IF . . . THEN

- 1 IF condition THEN statement
- 2 IF condition statement

Abbreviations: none for IF, T., TH., THE.

### Purpose

The IF . . . THEN verb pair is used to execute or not execute a statement depending on conditions at the time the program is run.

### Use

In the normal running of a BASIC programs, statements are executed in the sequence in which they occur. The IF . . . THEN verb pair allows decisions to be made during execution so that a given statement is executed only when desired. When the condition part of the IF statement is true, the statement is executed; when it is False, the statement is skipped.

The condition part of the IF statement can be any relational expression as described in Chapter 4. It is also possible to use a numeric expression as a condition, although the intent of the statement will be less clear. Any expression which evaluates to zero or a negative number is considered False; any which evaluates to a positive number is considered True.

The statement which follows the THEN may be any BASIC statement, including another IF . . . THEN. If it is a LET statement, the LET verb itself must appear. Unless the statement is an END, GOTO, or ON . . . GOTO, the statement following the IF . . . THEN statement is the next one executed regardless of whether the condition is True.

The two forms of the IF statement are identical in action, but the first form is clearer.

### Examples

```
10 INPUT "CONTINUE? ";A$
20 IF A$ = "YES" THEN GOTO 10
30 IF A$ = "NO" THEN GOTO 60
40 PRINT "YES OR NO, PLEASE"
50 GOTO 10
60 END
```

This program continues to ask 'CONTINUE?' as long as 'YES' is entered; it stops if 'NO' is entered, and complains otherwise.

**1 INPUT input list**Where: input listand: input groupand: var listand: promptis: input groupor: input group , input listis: var listor: prompt , var listor: prompt ; var listis: variableor: variable , var list

is: any string constant

Abbreviations: I., IN., INP., INPU.

See also: INPUT #, READ

**Purpose**

The INPUT verb is used to enter one or more values from the keyboard.

**Use**

When you want to enter different values each time a program is run, use the INPUT verb to enter these values from the keyboard.

In its simplest form the INPUT statement does not include a prompt string, instead a question mark is displayed on the left edge of the display. A value is then entered, followed by the **ENTER** key. This value is assigned to the first variable in the list. If other variables are included in the same INPUT statement, this process is repeated until the list is exhausted.

If a prompt is included in the INPUT statement, the process is exactly the same except that, instead of the question mark, the prompt string is displayed at the left edge of the display. If the prompt string is followed by a semicolon, the cursor is positioned immediately following the prompt. If the prompt is followed by a comma, the prompt is displayed, then when a key is pressed the display is cleared and the first character of the input is displayed at the left edge.

When a prompt is specified and there is more than one variable in the list following it, the second and succeeding variables are prompted with the question mark. If a second prompt is included in the list, it is displayed for the variable which immediately follows it.

## Verbs INPUT

If the **ENTER** key is pressed and no input is provided, the variable retains the value it had before the INPUT statement.

### Examples

10 INPUT A

20 INPUT "A="; A

30 INPUT "A=", A

40 INPUT "X=? "; X, "Y=? "; Y

Clears the display and puts a question mark at the left edge.

Displays 'A=' and waits for input data.

Displays 'A='.

When data is input 'A =' disappears and the data is displayed starting at left edge.

Displays 'X=?' and waits for first input.

After **ENTER** is pressed, display is cleared and 'Y=?' is displayed at left edge.

- 1 INPUT #
- 2 INPUT # "filename"
- 3 INPUT # var list
- 4 INPUT # "filename"; var list

Where: var list is: variable  
or: variable , var list

Abbreviations: I. #, IN. #, INP.#, INPU. #

See also: INPUT, PRINT #, READ

## Purpose

The INPUT # verb is used to enter values from the cassette tape.

## Use

PRINT # saves the values of variables on tape. They can then be read back into the same or another program using the INPUT # verb.

With the first form, the values are sequentially read from the tape and assigned to the 26 preallocated storage locations (fixed variables) and A( ) variables, (A(27) ~ ). The transfer continues until the values recorded on tape runs out or the computer memory is filled to the capacity.

With the second form, the tape is searched for the indicated filename and the variables are loaded as in the first form.

With the third form, if the variable names are A( ), this form sequentially transfers the values from tape to A( ) variables, including the specified variable, when their subscript is larger than that of the specified. (The same applies to the preallocated variables, fixed variables.)

With the fourth form, the tape is searched for the indicated filename and the variables are loaded from the values saved in that file.

There is a special variable form which may be used in the variable list. It looks like an array variable except that an asterisk is enclosed in the parentheses, e.g., B(\*) or F\$(\*). This form causes all values of the indicated variable to be restored from the tape including the simple variable of the same name; i.e., B(\*) restores B(0), B(1), B(2), etc., for as many values as were originally stored. You may not read a single element of an array.

### Examples

- |                           |                                                                                                                                 |
|---------------------------|---------------------------------------------------------------------------------------------------------------------------------|
| 1) 20 INPUT # A           | Reads values from the current position of the tape.                                                                             |
| 2) 20 INPUT # A(3)        | Reads values from the current position of the tape and assigns the values to the variables A(3) ~ A(26) (or C ~ Z) and A(27) ~. |
| 3) 20 INPUT # "FIL2";A\$  | Searches the tape for the file 'FIL2' and reads in values.                                                                      |
| 4) 20 INPUT # "FIL3";G(*) | Searches the tape for the file 'FIL3' and reads in G and as many values of G( ) as are available.                               |

### NOTES:

1. When the prerecorded data on tape is transferred to a variable, the data and variable should be coincident in shape (numerical or string variable), size and length. An error (ERROR 8) will result unless they are coincident in size and length. No error will occur when they are not coincident only in shape. In this case, however, the transfer of incorrect data may result when the numerical data is transferred to a string variable or the string data to a numerical variable. Therefore, the data and variable should also be coincident in shape.
2. The data transfer to variables in the fixed variables and/or in the shape of A ( ) terminates when the prerecorded data on tape is out or when the computer memory is filled to capacity.



1 LET variable = expression

2 variable = expression

Abbreviations: LE.

## Purpose

The LET verb is used to assign a value to a variable.

## Use

The LET verb assigns the value of the expression to the designated variable. The type of the expression must match that of the variable, i.e. only numeric expressions can be assigned to numeric variables and only string expressions can be assigned to string variables. In order to convert from one type to the other, one of the explicit type conversion functions, STR\$ or VAL, must be used.

The LET verb may be omitted in all LET statements except those which appear in the THEN clause of an IF ... THEN statement. In this one case the LET verb must be used.

## Examples

10 I = 10

20 A = 5 \* I

30 X\$ = STR\$(A)

40 IF I >= 10 THEN LET Y\$ = X\$ + ".00"

Assigns the value 10 to I.

Assigns the value 50 to A.

Assigns the value '50' to X\$.

Assigns the value '50.00' to Y\$.

- 1 **LPRINT** print expr
- 2 **LPRINT** print expr , print expr
- 3 **LPRINT** print list

Where: print list

is: print expr

and: print expr

or: print expr ; print list

is: expression

or: USING clause ; expression

The USING clause is described separately under USING

Abbreviations: LP., LPR., LPRI., LPRIN.

See also: PAUSE, PRINT, USING, and WAIT

### Purpose

The LPRINT verb is used to print information on the printer of the optional CE-125 Printer/Microcassette Recorder.

### Use

The LPRINT verb is used to print prompting information, results of calculations, etc. The first form of the LPRINT statement prints a single value. If the expression is numeric, the value will be printed at the far right edge of the paper. If it is a string expression, the print is made starting at the far left.

With the second form of the LPRINT statement the paper is divided into two 12 character halves and the two values are printed in each half according to the same rules as above.

With the third form the print always starts at the left edge and each value is printed immediately following the previous value from left to right with no intervening space.

It is possible to cause PRINT statements to work as LPRINT statements. See the PRINT verb for details.

If an LPRINT statement contains more than 24 characters, the first 24 are printed on one line, the next 24 on the next line, and so forth.

Unlike PRINT, there is no halt or wait after execution of an LPRINT statement.

**Examples**

```
10 A=10: B=20: X$ = "ABCDEF"
20 LPRINT A
30 LPRINT X$
40 LPRINT A, B
50 LPRINT A; B; X$
```

Paper

```
ABCDEF
10. 20.
10.20.ABCDEF
```

1 **NEXT** numeric variable

Abbreviations: N., NE., NEX.

See also: FOR

### Purpose

The NEXT verb is used to mark the end of a group of statements which are being repeated in a FOR/NEXT loop.

### Use

The use of the NEXT verb is described under FOR. The numeric variable in a NEXT statement must match the numeric variable in the corresponding FOR.

### Examples

```
10 FOR I = 1 TO 10
20 PRINT I
30 NEXT I
```

Print the numbers from 1 to 10.

1 ON expression GOSUB expression list

Where: expression list is: expression  
or: expression , expression list

Abbreviations: O. ; GOS., GOSU.

See also: GOSUB, GOTO, ON ... GOTO

## Purpose

The ON ... GOSUB verb is used to execute one of a set of subroutines depending on the value of a control expression.

## Use

When the ON ... GOSUB verb is executed the expression between ON and GOSUB is evaluated and reduced to an integer. If the value of the integer is 1, the first subroutine in the list is executed as in a normal GOSUB. If the expression is 2, the second subroutine in the list is executed, and so forth. After the RETURN from the subroutine execution proceeds with the statement which follows the ON ... GOSUB.

If the expression is zero, negative, or larger than the number of subroutines provided in the list, no subroutine is executed and execution proceeds with the next line of the program.

NOTE: Commas may not be used in the expressions following the GOSUB. The PC-1245 cannot distinguish between commas in expressions and commas between expressions.

## Examples

```
10 INPUT A
20 ON A GOSUB 100, 200, 300
30 END
100 PRINT "FIRST"
110 RETURN
200 PRINT "SECOND"
210 RETURN
300 PRINT "THIRD"
310 RETURN
```

An input of 1 prints "FIRST"; 2 prints "SECOND"; 3 prints "THIRD". Any other input does not produce any print.

1 ON expression GOTO expression list

Where: expression list is: expression  
or: expression , expression list

Abbreviations: O.; G., GO., GOT.

See also: GOSUB, GOTO, ON ... GOSUB

## Purpose

The ON ... GOTO verb is used to transfer control to one of a set of locations depending on the value of a control expression.

## Use

When the ON ... GOTO verb is executed the expression between ON and GOTO is evaluated and reduced to an integer. If the value of the integer is 1, control is transferred to the first location in the list. If the expression is 2, control is transferred to the second location in the list; and so forth.

If the expression is zero, negative, or larger than the number of locations provided in the list, execution proceeds with the next line of the program.

NOTE: Commas may not be used in the expressions following the GOTO. The PC-1245 cannot distinguish between commas in expressions and commas **between** expressions.

## Examples

```
10 INPUT A
20 ON A GOTO 100,200,300
30 GOTO 900
100 PRINT "FIRST"
110 GOTO 900
200 PRINT "SECOND"
210 GOTO 900
300 PRINT "THIRD"
310 GOTO 900
900 END
```

An input of 1 prints 'FIRST'; 2 prints 'SECOND'; 3 prints 'THIRD'. Any other input does not produce any print.

- 1 PAUSE print expr
- 2 PAUSE print expr , print expr
- 3 PAUSE print list

Where: print list is: print expr  
or: print expr ; print list

and: print expr is: expression  
or: USING clause ; expression

The USING clause is described separately under USING

Abbreviations: PAU., PAUS.

See also: LPRINT, PRINT, USING, and WAIT

## Purpose

The PAUSE verb is used to print information on the display for a short period.

## Use

The PAUSE verb is used to display prompting information, results of calculations, etc. The operation of PAUSE is identical to PRINT except that after PAUSE the PC-1245 waits for a short preset interval of about .85 seconds and then continues execution of the program without waiting for the ENTER key or the WAIT interval.

The first form of the PAUSE statement displays a single value. If the expression is numeric, the value is printed at the far right end of the display. If it is a string expression, the display is made starting at the far left.

With the second form of the PAUSE statement the display is divided into two 8 character halves. The two values are displayed in each half according to the same rules as above.

With the third form the display starts at the left edge and each value is displayed immediately following the previous value from left to right with no intervening space.

PAUSE statements are not affected by the PRINT = LPRINT statement (see PRINT).

While it is possible to write PAUSE statements which would display more than 16 characters only the left-most 16 appear in the display. There is no way to see the other characters.

**Examples**

10 A = 10 : B = 20 : X\$ = "ABCDEF"

20 PAUSE A

30 PAUSE X\$

40 PAUSE A, B

50 PAUSE A; B; X\$

Display

|                |     |     |
|----------------|-----|-----|
|                |     | 10. |
| ABCDEF         |     |     |
|                | 10. | 20. |
| 10. 20. ABCDEF |     |     |



- 1 PRINT print expr
- 2 PRINT print expr , print expr
- 3 PRINT print list
- 4 PRINT = LPRINT
- 5 PRINT = PRINT

Where: print list is: print expr  
or: print expr ; print list  
and: print expr is: expression  
or: USING clause ; expression

The USING clause is described separately under USING

Abbreviations: P., PR., PRI., PRIN.

See also: LPRINT, PAUSE, USING, and WAIT

### Purpose

The PRINT verb is used to print information on the display or on the printer of the CE-125 Printer/Microcassette Recorder.

### Use

The PRINT verb is used to display prompting information, results of calculations, etc. The first form of the PRINT statement displays a single value. If the expression is numeric, the value is printed at the far right end of the display. If it is a string expression, the display is made starting at the far left.

With the second form of the PRINT statement the display is divided into two 8 character halves and the two values are displayed in each half according to the same rules as above.

With the third form the display starts at the left edge and each value is displayed immediately following the previous value from left to right with no intervening space.

The fourth and fifth forms of the PRINT statement do no printing. The fourth form causes all PRINT statements which follow it in the program to be treated as if they were LPRINT statements. The fifth form resets this condition so that the PRINT statements will again work with the display.

While it is possible to write PRINT statements which would display more than

**Verbs**  
**PRINT**

16 characters, only the left-most 16 appear in the display. There is no way to see the other characters.

**Examples**

10 A = 10 : B = 20 : X\$ = "ABCDEF"

20 PRINT A

30 PRINT X\$

40 PRINT A, B

50 PRINT A; B; X\$

Display

|                |
|----------------|
| 10.            |
| ABCDEF         |
| 10. 20.        |
| 10. 20. ABCDEF |

promsoft.com

- 1 PRINT #
- 2 PRINT # "filename"
- 3 PRINT # "var list"
- 4 PRINT # "filename"; var list

Where: var list is: variable  
or: variable , var list

Abbreviations: P. #, PR. #, PRI. #, PRIN. #

See also: INPUT #, PRINT, READ

## Purpose

The PRINT # verb is used to store values on the cassette tape.

## Use

Using PRINT # the values of variables can be saved on tape. These can then be read back into the same or another program using the INPUT # verb.

With the first form, the values of the 26 preallocated variables (variables A ~ Z and A\$ ~ Z\$), A( ) and A\$( ) variables are stored on the tape.

Note: Variables A ~ Z and A(1) ~ A(26) are the same in the content.

With the second form, the values are stored on the tape as in the first form under the designated filename.

With the third form, if the variable names are A( ), this form of the verb stores on tape all the contents of A( ) variables, including the specified variables when their subscript is larger than that of the specified.

(The same applies to the variables specified in the form of A, B, C, --.)

With the fourth form, the values are stored on the tape as in the third form under the designated filename.

There is a special variable form which may be used in the variable list. It looks like an array variable except that an asterisk is enclosed in the parentheses, e.g., B(\*) or F\$(\*). This form causes all values of the indicated variable to be saved on the tape including the simple variable of the same name, i.e., B(\*) saves B and B(0), B(1), B(2), etc., for as many values as are in the array. You may not save a single element of an array.

Verbs  
PRINT #

### Examples

- 1) 10 PRINT # A
- 2) 10 PRINT # "FIL2";A\$
- 3) 10 PRINT # "FIL3";G(\*)

Saves values on the tape at the current position.

Saves values on the tape under the filename 'FIL2'.

Saves G and values of G ( ) on the tape under the filename 'FIL3'.

#### Note:

A variable above A(27) or a dimensional variable must be secured into the program/data area before the PRINT # command is executed. If the variable is not designated before the PRINT # command, an error (ERROR 3) will result.

## 1 RADIANT

Abbreviations: RAD., RADI., RADIA.

See also: DEGREE and GRAD

### Purpose

The RADIANT verb is used to change the form of angular values to radian form.

### Use

The PC-1245 has three forms for representing angular values — decimal degrees, radians, and gradient. These forms are used in specifying the arguments to the SIN, COS, and TAN functions and in returning the results from the ASN, ACS, and ATN functions.

The RADIANT function changes the form for all angular values to radian form until a DEGREE or GRAD verb is used. Radian form represents angles in terms of the length of the arc with respect to a radius, i.e.,  $360^\circ$  is  $2\pi$  radians since the circumference of a circle is  $2\pi$  times the radius.

### Examples

10 RADIANT

20 X = ASN 1

X now has a value of 1.570796327 or  $\pi/2$ , the Arcsine of 1.

## 1 RANDOM

Abbreviations: RA., RAN., RAND., RANDO.

### Purpose

The RANDOM verb is used to reset the seed for random number generation.

### Use

When random numbers are generated using the RND function, the PC-1245 begins with a predetermined "seed" or starting number. The RANDOM verb resets this seed to a new randomly determined value.

The starting seed will be the same each time the PC-1245 is turned on, so the sequence of random numbers generated with RND is the same each time, unless the seed is changed. This is very convenient during the development of a program because it means that the behavior of the program should be the same each time it is run even though it includes a RND function. When you want to have the numbers be truly random, the RANDOM statement can be used to make the seed itself random.

### Examples

```
10 RANDOM
20 X = RND 10
```

When run from line 20, the value of X is based on the standard seed. When run from line 10, a new seed is used.

**1 READ variable list**Where: variable listis: variableor: variable , variable list

Abbreviations: REA.

See also: DATA, RESTORE

**Purpose**

The READ verb is used to read values from a DATA statement and assign them to variables.

**Use**

When assigning initial values to an array, it is convenient to list the values in a DATA statement and use a READ statement in a FOR . . . NEXT loop to load the values into the array. When the first READ is executed, the first value in the first DATA statement is returned. Succeeding READs use succeeding values in the sequential order in which they appear in the program, regardless of how many values are listed in each DATA statement or how many DATA statements are used.

If desired, the values in a DATA statement can be read a second time by using the RESTORE statement.

**Examples**

```
10 DIM B(10)
20 FOR I = 1 TO 10
30 READ B(I)
40 NEXT I
50 DATA 1, 2, 3, 4, 5, 6
60 DATA 7, 8, 9, 10
```

Sets up an array

Loads the values from the DATA statement into B ( ) — B (1) is 1, B (2) is 2, B (3) is 3, etc.

1 REM remark

Abbreviations: none

### Purpose

The REM verb is used to include comments in a program.

### Use

Often it is useful to include explanatory comments in a program. These can provide titles, names of authors, dates of last modification, usage notes, reminders about algorithms used, etc. These comments are included by means of the REM statement.

The REM statement has no effect on the program execution and can be included anywhere in the program. Everything following the REM verb in that line is treated as a comment, so the REM verb must be the last statement in a line when multiple statement lines are used.

### Examples

```
10 REM THIS LINE HAS NO EFFECT
```



- 1 RESTORE
- 2 RESTORE expression

Abbreviations: RES., REST., RESTO., RESTOR.

See also: DATA, READ

### Purpose

The RESTORE verb is used to reread values in a DATA statement or to change the order in which these values are read.

### Use

In the regular use of the READ verb the PC-1245 begins reading with the first value in a DATA statement and proceeds sequentially through the remaining values. The first form of the RESTORE statement resets the pointer to the first value of the first DATA statement, so that it can be read again. The second form of the RESTORE statement resets the pointer to the first value of the first DATA statement whose line number is greater than the value of the expression.

### Examples

10 DIM B(10)

Sets up an array

20 FOR I = 1 TO 10

30 READ B(I)

Assigns the value 10 to each of the elements of B ( ).

40 RESTORE

50 NEXT I

60 DATA 10

## 1 RETURN

Abbreviations: RE., RET., RETU., RETUR.

See also: GOSUB, ON . . . GOSUB

### Purpose

The RETURN verb is used at the end of a subroutine to return control to the statement following the originating GOSUB.

### Use

A subroutine may have more than one RETURN statement, but the first one executed terminates the execution of the subroutine. The next statement executed will be the one following the GOSUB or ON . . . GOSUB which calls the subroutine. If a RETURN is executed without a GOSUB, an Error 5 will occur.

### Examples

```
10 GOSUB 100
20 END
100 PRINT "HELLO"
110 RETURN
```

When run this program prints the word "HELLO" one time.

**1 STOP**

Abbreviations: S., ST., STO.,

See also: END; CONT command

**Purpose**

The STOP verb is used to halt execution of a program for diagnostic purposes.

**Use**

When the STOP verb is encountered in program execution the **PC-1245** execution halts and a message is displayed such as 'BREAK IN 200' where 200 is the number of the line containing the STOP. STOP is used during the development of a program to check the flow of the program or examine the state of variables. Execution may be restarted using the CONT command.

**Examples**

10 STOP

Causes "BREAK IN 10" to appear in the display.

## 1 TROFF

Abbreviations : TROF.

See also: TRON

### Purpose

The TROFF verb is used to cancel the trace mode.

### Use

Execution of the TROFF verb restores normal execution of the program.

### Examples

```
10 TRON
20 FOR I = 1 TO 3
30 NEXT I
40 TROFF
```

When run, this program displays the line numbers 10, 20, 30, 30, 30 and 40.

## 1 TRON

Abbreviations : TR., TRO.

See also: TROFF

### Purpose

The TRON verb is used to initiate the trace mode.

### Use

The trace mode provides assistance in debugging programs. When the trace mode is on, the line number of each statement is displayed **after** each statement is executed. The PC-1245 then halts and waits for the Down Arrow key to be pressed before moving on to the next statement. The Up Arrow key may be pressed to see the statement which has just been executed. The trace mode continues until a TROFF verb is executed.

### Examples

```
10 TRON
20 FOR I = 1 TO 3
30 NEXT I
40 TROFF
```

When run this program displays the line numbers 10, 20, 30, 30, 30 and 40.

- 1 USING
- 2 USING "editing specification"
- 3 USING character variable

Abbreviations: U., US., USI., USIN.

See also: LPRINT, PAUSE, PRINT

Further guide to the use of USING is provided in Appendix C

## Purpose

The USING verb is used to control the format of displayed or printed output.

## Use

The USING verb can be used by itself or as a clause within a LPRINT, PAUSE, or PRINT statement. The USING verb establishes a specified format for output which is used for all output which follows until changed by another USING verb.

The editing specification of the USING verb consists of a quoted string composed of some combination of the following editing characters:

- # Right justified numeric field character
  - Decimal point.
- ^ Used to indicate that numbers should be displayed in scientific notation.
- & Left justified alphanumeric field.

For example, "#####" is an editing specification for a right justified numeric field with room for 3 digits and the sign. In numeric fields, a location must be included for the sign, even if it will always be positive.

Editing specifications may include more than one field. For example "####&&&&" could be used to print a numeric and a character field next to each other.

If the editing specification is missing, as in format 1, special formatting is turned off and the built-in display rules pertain.

## Examples

10 A = 125 : X\$ = "ABCDEF"

20 PRINT USING "##.## ^"; A

30 PRINT USING "&&&&&&&"; X\$

40 PRINT USING "####&&"; A; X\$

## Display

|          |
|----------|
| 1.25E 02 |
|----------|

|        |
|--------|
| ABCDEF |
|--------|

|        |
|--------|
| 125ABC |
|--------|

- Notes:
1. When the total number of digits specified with USING exceeds 16 for "PRINT expression", ERROR 7 results.
  2. When the number of digits for the integer part (sign and decimal point included) exceeds 8 while using the fixed decimal point system for "PRINT expression , expression", ERROR 7 results.  
When the character string of the expression in the form of "PRINT expression , expression" exceeds 8 columns, the excess part is not displayed.
  3. When the display contents of the form "PRINT expression ; expression" exceeds 16 columns, the excess part is not displayed.

1 WAIT

2 WAIT expression

Abbreviations: W., WA., WAI.

See also: PAUSE, PRINT

### Purpose

The WAIT verb is used to control the length of time that displayed information is shown before program execution continues.

### Use

In normal execution the PC-1245 halts execution after a PRINT command until the **ENTER** key is pressed. The WAIT command causes the PC-1245 to display for a specified interval and then proceed automatically (similar to the PAUSE verb). The expression which follows the WAIT verb determines the length of the interval. The interval may be set to any value from 0 to 65535. Each increment is about one sixty-fourth of a second. WAIT 0 is too fast to be read reasonably; WAIT 65535 is about 17 minutes. WAIT with no following expression resets the PC-1245 to the original condition of waiting until the **ENTER** key is pressed.

### Examples

10 WAIT 64

Causes PRINT to wait about 1 second.



# FUNCTIONS

## Pseudovariabes

Pseudovariabes are a group of functions which take no argument and are used like simple variables wherever required.

### 1 INKEY\$

INKEY\$ is a string pseudovariabes which has the value of the last key pressed on the keyboard. **ENTER**, **CL**, **SHIFT**, **DEF**, **↑**, **↓**, **▶**, and **◀** all have a value of NUL. INKEY\$ is used to respond to the pressing of individual keys without waiting for the ENTER key to end the input.

```
10 A$ = INKEY$
20 B = ASC A$
30 IF B = 0 THEN GOTO 10
40 IF B
```

Lines 40 and beyond contain tests for the key and the actions to be taken. On first executing the program, the value of INKEY\$ is NUL, since the last key pressed was **ENTER**. If INKEY\$ is used following PRINT or PAUSE, the contents of the display are read instead of a key press.

### 1 MEM

MEM is a numeric pseudovariabes which has the value of the number of characters of program memory remaining. The available program memory will be the total memory less the space consumed by programs and array variables. MEM may also be used as a command. Immediately following reset, MEM has a value of 1486.

### 1 PI

## Functions

### Numeric Functions

PI is a numeric pseudovisible which has the value of PI. It is identical to the use of the special PI character ( $\pi$ ) on the keyboard. Like other numbers the value of PI is kept to 10 digit accuracy (3.141592654).

### Numeric Functions

Numeric functions are a group of mathematical operations which take a single numeric value and return a numeric value. They include trigonometric functions, logarithmic functions, and functions which operate on the integer and sign parts of a number. Many dialects of BASIC require that the argument to a function be enclosed in parentheses. The PC-1245 does not require these parentheses, except when it is necessary to indicate what part of a more complex expression is to be included in the argument.

LOG 100 + 100 will be interpreted as:

(LOG 100) + 100      not      LOG (100 + 100).

1 ABS numeric expression

ABS is numeric function which returns the absolute value of the numeric argument. The absolute value is the value of a number without regard to its sign. ABS -10 is 10.

1 ACS numeric expression

ACS is a numeric function which returns the arccosine of the numeric argument. The arccosine is the angle whose cosine is equal to the expression. The value returned depends on whether the PC-1245 is in decimal degree, radian, or gradient mode for angles. ACS .5 is 60 in the decimal degree mode.

1 ASN numeric expression

ASN is a numeric function which returns the arcsine of the numeric argument. The arcsine is the angle whose sine is equal to the expression. The value returned depends on whether the **PC-1245** is in decimal degree, radian, or gradient mode for angles. ASN .5 is 30 in the decimal degree mode.

1 **ATN** numeric expression

ATN is a numeric function which returns the arctangent of the numeric argument. The arctangent is the angle whose tangent is equal to the expression. The value returned depends on whether the **PC-1245** is in decimal degree, radian, or gradient mode for angles. ATN 1. is 45 in the decimal degree mode.

1 **COS** numeric expression

COS is a numeric function which returns the cosine of the angle argument. The value returned depends on whether the **PC-1245** is in decimal degree, radian, or gradient mode for angles. COS 60 is .5 in the decimal degree mode.

1 **DEG** numeric expression

The DEG function converts an angle argument in DMS (Degree, Minute, Second) format to DEG (Decimal Degree) form. In DMS format the integer portion of the number represents the degrees, the first and second digits of the decimal represent the minutes, the third and fourth digits of the decimal represent the seconds, and any further digits represent decimal seconds. For example, 55° 10' 44.5" is represented as 55.10445. In DEG format the integer portion is degrees and the decimal portion is decimal degrees. DEG 55.10445 is 55.17902778.

1 **DMS** numeric expression

DMS is a numeric function which converts an angle argument in DEG format to DMS format (see DEG). DMS 55.17902778 is 55.10445.

**Functions**  
**Numeric Functions**

1 **EXP** numeric expression

EXP is a numeric function which returns the value of  $e$  (2.718281828 – the base of the natural logarithms) raised to the value of the numeric argument. EXP 1 is 2.718281828.

1 **INT** numeric expression

INT is a numeric function which returns the integer part of its numeric argument. INT PI is 3.

1 **LOG** numeric expression

LOG is a numeric function which returns the logarithm to the base 10 of its numeric argument. LOG 100 is 2.

1 **LN** numeric expression

LN is a numeric function which returns the logarithm to the base  $e$  (2.718281828) of its numeric argument. LN 100 is 4.605170186.

1 **RND** numeric expression

RND is a numeric function which generates random numbers. If the value of the argument is less than one but greater than or equal to zero, the random number is less than one and greater than or equal to zero. If the argument is an integer greater than or equal to 1, the result is a random number greater than or equal to 1 and less than or equal to the argument. If the argument is greater than or equal to 1 and not an integer, the result is a random number greater than or equal to 1 and less than or equal to the smallest integer which is larger than the argument: (In this case, the generation of the random number changes depending on the value of the decimal portion of the argument.):

| <u>Argument</u> | ----- Result ----- | <u>Lower Bound</u> | <u>Upper Bound</u> |
|-----------------|--------------------|--------------------|--------------------|
| .5              |                    | 0                  | <1                 |
| 2               |                    | 1                  | 2                  |
| 2.5             |                    | 1                  | 3                  |

The same sequence of random numbers is normally generated because the same "seed" is used each time the PC-1245 is turned on. To randomize the seed, see the RANDOM verb.

1 **SGN** numeric expression

SGN is a numeric function which returns a value based on the sign of the argument. If the argument is positive, the result is 1; if the argument is zero, the result is 0; if the argument is negative, the result is -1. SGN -5 is -1.

1 **SIN** numeric expression

SIN is a numeric function which returns the sine of the angle argument. The value returned depends on whether the PC-1245 is in decimal degree, radian, or gradient mode for angles. SIN 30 is .5.

1 **SQR** numeric expression

SQR is a numeric function which returns the square root of its argument. It is identical to the use of the special square root symbol ( $\sqrt{\quad}$ ) on the keyboard. SQR 4 is 2.

1 **TAN** numeric expression

TAN is a numeric function which returns the tangent of its angle argument. The value returned depends on whether the **PC-1245** is in decimal degree, radian, or gradient mode for angles. TAN 45 is 1.

## String Functions

String functions are a group of operations used for manipulating strings. Some take a string argument and return a numeric value. Some take a string argument and return a string. Some take a numeric value and return a string. Some take a string argument and one or two numeric arguments and return a string. Many dialects of BASIC require the argument of a function to be enclosed in parentheses. The **PC-1245** does not require these parentheses, except when it is necessary to indicate what part of a more complex expression is to be included in the argument. String functions with two or three arguments all require the parentheses.

### 1 **ASC** string expression

ASC is a string function which returns the numeric ASCII code value of the first character in its argument. The chart of ASCII codes and their relationship to characters is given in Appendix B. ASC "A" is 65.

### 1 **CHR\$** numeric expression

CHR\$ is a string function which returns the character which corresponds to the numeric ASCII code of its argument. The chart of ASCII codes and their relationship to characters is given in Appendix B. CHR\$ 65 is "A".

### 1 **LEFT\$** (string expression, numeric expression)

LEFT\$ is a string function which returns the leftmost part of the string first argument. The number of characters returned is determined by the numeric expression. LEFT\$ ("ABCDEF", 2) is "AB".

### 1 **LEN** string expression

LEN is a string function which returns the length of the string argument. LEN "ABCDEF" is 6.

1 **MID\$** (string expression , num. exp. 1 , num. exp. 2)

MID\$ is a string function which returns a middle portion of the string first argument. The first numeric argument indicates the first character position to be included in the result. The second numeric argument indicates the number of characters that are to be included. MID\$ ("ABCDEF", 2, 3) is "BCD".

1 **RIGHT\$** (string expression , numeric expression)

RIGHT\$ is a string function which returns the rightmost part of the string first argument. The number of characters returned is determined by the numeric argument. RIGHT\$ ("ABCDEF", 3) is "DEF".

1 **STR\$** numeric expression

STR\$ is a string function which returns a string which is the character representation of its numeric argument. It is the reverse of VAL. STR\$ 1.59 is '1.59'.

1 **VAL** string expression

VAL is a string function which returns the numeric value of its string argument. It is the reverse of STR\$. The VAL of a non-number is zero. VAL "1.59" is 1.59.

Note: The character-string convertible by VAL function to a numerical value consists of numerals (0 to 9), symbols (+ and -) and a symbol (E) indicating an exponential portion. No other characters and symbols are included. If a character-string includes other characters and symbols, any character-string on the right of that character-string will be ignored. If included in a character-string, a space is usually regarded as non-existing. If, however, a space is included in the portion (on the right of E) corresponding to an exponential part, any character-string on the right of the space will be ignored.



# CHAPTER 9

## TROUBLESHOOTING

This chapter provides you with some hints on what to do when your **SHARP PC-1245** does not do what you expect it to do. It is divided into two parts — the first part deals with general machine operation and the second with BASIC programming. For each problem there are a series of suggestions provided. You should try each of these, one at a time, until you have fixed the problem.

### Machine Operation

| If:                                                                                                  | Then You Should:                                                                                                                                                                                                                                                                                      |
|------------------------------------------------------------------------------------------------------|-------------------------------------------------------------------------------------------------------------------------------------------------------------------------------------------------------------------------------------------------------------------------------------------------------|
| You turn on the machine but there is nothing on the display                                          | <ol style="list-style-type: none"> <li>1. Check to see that the slide switch is set to RUN or PRO.</li> <li>2. Push the <b>ON</b> <b>BRK</b> key to see if AUTO POWER OFF has been activated.</li> <li>3. Replace the batteries.</li> </ol>                                                           |
| There is a display, but no response to keystrokes                                                    | <ol style="list-style-type: none"> <li>1. Press <b>CL</b> key to clear.</li> <li>2. Press <b>CA</b> ( <b>SHIFT</b> <b>CL</b> ) to clear.</li> <li>3. Turn OFF and ON again.</li> <li>4. Hold down any key and push RESET.</li> <li>5. Push RESET without any key.</li> </ol>                          |
| You have typed in a calculation or answer and get no response                                        | <ol style="list-style-type: none"> <li>1. Push <b>ENTER</b>.</li> </ol>                                                                                                                                                                                                                               |
| You are running a BASIC program and it displays something, and stops                                 | <ol style="list-style-type: none"> <li>1. Push <b>ENTER</b>.</li> </ol>                                                                                                                                                                                                                               |
| You enter a calculation and it is displayed in BASIC statement format (colon after the first number) | <ol style="list-style-type: none"> <li>1. Switch from the PROgram into the RUN mode for calculations.</li> </ol>                                                                                                                                                                                      |
| You get no response from any keys.                                                                   | <ol style="list-style-type: none"> <li>1. Hold down any key and push RESET.</li> <li>2. If you get no response from any key even when the above operation is performed, push the RESET <u>without pushing any key</u>. This will <u>clear the program, data and all reserved contents</u>.</li> </ol> |

## BASIC Debugging

When entering a new BASIC program, it is usual for it **not** to work the first time. Even if you are simply keying in a program that you know is correct, such as those provided in this manual, it is usual to make at least one typing error. If it is a new program of any length, it will probably contain at least one logic error as well. Following are some general hints on how to find and correct your errors.

You run your program and get an error message:

1. Go back to the PROgram mode and use the ↑ or the ↓ keys to recall the line with the error. The cursor will be positioned at the place in the line where the **PC-1245** got confused.
2. If you can't find an obvious error in the way in which the line is written, the problem may lie with the values which are being used. For example, **CHR\$(A)** will produce an error if **A** has a value of 1 because **CHR\$(1)** is an illegal character. Check the values of the variables in either the **RUN** or the **PROgram** mode by typing in the name of the variable followed by ENTER.

You **RUN** the program and don't get an error message, but it doesn't do what you expect.

3. Check through the program line by line using **LIST** and the ↓ and ↑ keys to see if you have entered the program correctly. It is surprising how many errors can be fixed by just taking another look at the program.
4. Think about each line as you go through the program as if you were the computer. Take sample values and try to apply the operation in each line to see if you get the result that you expected.
5. Insert one or more extra **PRINT** statements in your program to display key values and key locations. Use these to isolate the parts of the program that are working correctly and the location of the error. This approach is also useful for determining which parts of a program have been executed. You can also use **STOP** to temporarily halt execution at critical points so that several variables can be examined.
6. Use **TRON** and **TROFF**, either as commands or directly within the program to trace the flow of the program through individual lines. Stop to examine the contents of critical variables at crucial points. This is a very slow way to find a problem, but sometimes it is also the only way.

## CHAPTER 10 MAINTENANCE OF THE PC-1245

To insure trouble-free operation of your **SHARP PC-1245** we recommend the following:

- \* Always handle the pocket computer carefully as the liquid crystal display is made of glass.
- \* Keep the computer in an area free from extreme temperature changes, moisture, or dust. During warm weather, vehicles left in direct sunlight are subject to high temperature build up. Prolonged exposure to high temperature may cause damage to your computer.
- \* Use only a soft, dry cloth to clean the computer. Do not use solvents, water, or wet cloths.
- \* To avoid battery leakage, remove the batteries when the computer will not be in use for an extended period of time.
- \* If service is required, the computer should only be returned to an authorized **SHARP** Service Center.
- \* If the computer is subjected to strong static electricity or external noise it may "hang up" (all keys become inoperative). If this occurs, press the **ALL RESET** button while holding down any key. (See Troubleshooting).
- \* Keep this manual for further reference.

(NOTE: For maintenance of the **CE-125** please see Chapter 7.)

## APPENDIX A ERROR MESSAGES

There are nine different error codes built into the PC-1245. The following table will explain these codes.

| Error Number | Meaning                                                                                                                                                                                                                                                                                                                                                                                                                                                                                                                                                                                                                                                                                                                                        |
|--------------|------------------------------------------------------------------------------------------------------------------------------------------------------------------------------------------------------------------------------------------------------------------------------------------------------------------------------------------------------------------------------------------------------------------------------------------------------------------------------------------------------------------------------------------------------------------------------------------------------------------------------------------------------------------------------------------------------------------------------------------------|
| 1            | Syntax error. <ul style="list-style-type: none"><li>• This means that the PC-1245 can't understand what you have entered. Check for things such as semicolons on the ends of PRINT statements, misspelled words, and incorrect usages.<br/><math>3 * / 2</math></li></ul>                                                                                                                                                                                                                                                                                                                                                                                                                                                                      |
| 2            | Calculation error.<br>Here you have probably done one of three things: <ol style="list-style-type: none"><li>1. Tried to use too large a number.<br/>Calculation results are greater than 9.999999999E 99.</li><li>2. Tried to divide by zero.<br/><math>5 / 0</math></li><li>3. An illogical calculation has been attempted.<br/>LN -30 or ASN 1.5</li></ol>                                                                                                                                                                                                                                                                                                                                                                                  |
| 3            | DIMension error/Augument error. <ul style="list-style-type: none"><li>• Array variable already exists.<br/>Array specified without first dimensioning it.<br/>Array subscript exceeds size of array specified in DIM statement.<br/>DIM B(256)</li><li>• Illegal function argument. This means that you have tried to make the computer do something that it just can't handle. An example is specifying a top limit for a FOR . . . NEXT loop that is greater than 32767. The reason for the error in this case is that the top limit for a FOR . . . NEXT loop is stored in just two bytes. The maximum, positive, signed integer value that two bytes can hold is 32767.<br/><math>10 \text{ FOR } A = 1 \text{ TO } 32768</math></li></ul> |

- 4 Line Number error.  
Here you have probably done one of two things:
1. Tried to use an unexisting line number by the GOTO, GOSUB, RUN, LIST or THEN etc.
  2. Tried to use too large a line number. The maximum line number is 999.
- 5 Nesting error.  
Subroutine nesting exceeds 10 levels.  
FOR loop nesting exceeds 5 levels.  
RETURN verb without a GOSUB, NEXT verb without a FOR, or READ verb without a DATA.  
Buffer space exceeded.
- 6 Memory Overflow.  
Generally this error happens when you've tried to DIMension an array that is too big for memory. This can also happen when a program becomes too large.
- 7 PRINT USING error.  
This means that you have put an illegal format specifier into a USING statement.
- 8 I/O device error.  
This error can happen only when you have the optional printer and/or cassette recorder connected to the PC-1245. It means that there is a problem with communication between the I/O device and the PC-1245.
- 9 Other errors.  
This code will be displayed whenever the computer has a problem that isn't covered by one of the other eight error codes. One of the most common causes for this error is trying to access data in a variable in one fashion (e.g. A\$) while the data was originally stored in the variable in another fashion (e.g. A).

## APPENDIX B ASCII CHARACTER CODE CHART

The following chart shows the conversion values for use with CHR\$ and ASC. The column shows the first hex character or the first four binary bits, the row shows the second hex character or the second binary bits. The upper left corner of each box contains the decimal number for the character. The lower right shows the character. If no character is shown then it is an illegal character on the PC-1245. For example, the character 'A' is a decimal 65 or a hex 41 or a binary 01000001.

promsoft.com

# ASCII Character Code Chart

First 4 bits

PC-1245 does not recognize codes in shaded area. If you enter the code number in the shaded area, an error will result.

S  
e  
c  
o  
n  
d  
  
4  
  
B  
i  
t  
s

| Hex Binary | 0        | 1    | 2           | 3       | 4       | 5       | 6       | 7    |
|------------|----------|------|-------------|---------|---------|---------|---------|------|
|            | 0000     | 0001 | 0010        | 0011    | 0100    | 0101    | 0110    | 0111 |
| 0<br>0000  | 0<br>NUL | 16   | 32<br>SPACE | 48<br>0 | 64<br>@ | 80<br>P | 96<br>E | 112  |
| 1<br>0001  | 1        | 17   | 33<br>!     | 49<br>1 | 65<br>A | 81<br>Q | 97      | 113  |
| 2<br>0010  | 2        | 18   | 34<br>"     | 50<br>2 | 66<br>B | 82<br>R | 98      | 114  |
| 3<br>0011  | 3        | 19   | 35<br>#     | 51<br>3 | 67<br>C | 83<br>S | 99      | 115  |
| 4<br>0100  | 4        | 20   | 36<br>\$    | 52<br>4 | 68<br>D | 84<br>T | 100     | 116  |
| 5<br>0101  | 5        | 21   | 37<br>%     | 53<br>5 | 69<br>E | 85<br>U | 101     | 117  |
| 6<br>0110  | 6        | 22   | 38<br>&     | 54<br>6 | 70<br>F | 86<br>V | 102     | 118  |
| 7<br>0111  | 7        | 23   | 39<br>□     | 55<br>7 | 71<br>G | 87<br>W | 103     | 119  |
| 8<br>1000  | 8        | 24   | 40<br>(     | 56<br>8 | 72<br>H | 88<br>X | 104     | 120  |
| 9<br>1001  | 9        | 25   | 41<br>)     | 57<br>9 | 73<br>I | 89<br>Y | 105     | 121  |
| A<br>1010  | 10       | 26   | 42<br>*     | 58<br>: | 74<br>J | 90<br>Z | 106     | 122  |
| B<br>1011  | 11       | 27   | 43<br>+     | 59<br>; | 75<br>K | 91<br>√ | 107     | 123  |
| C<br>1100  | 12       | 28   | 44<br>,     | 60<br>< | 76<br>L | 92      | 108     | 124  |
| D<br>1101  | 13       | 29   | 45<br>-     | 61<br>= | 77<br>M | 93<br>π | 109     | 125  |
| E<br>1110  | 14       | 30   | 46<br>.     | 62<br>> | 78<br>N | 94<br>^ | 110     | 126  |
| F<br>1111  | 15       | 31   | 47<br>/     | 63<br>? | 79<br>O | 95<br>- | 111     | 127  |

## APPENDIX C FORMATTING OUTPUT

It is sometimes important or useful to control the format as well the content of output. The **PC-1245** controls display formats with the **USING** verb. This verb allows you to specify:

- \* The number of digits
- \* The location of the decimal point
- \* Scientific notation format
- \* The number of string characters

These different formats are specified with an "output mask". This mask may be a string constant or a string variable:

1Ø: USING "####"  
2Ø: M\$ = "&&&&&"  
3Ø: USING M\$

When the **USING** verb is used with no mask, all special formatting is cancelled.

4Ø: USING

A **USING** verb may also be used within a **PRINT** statement:

5Ø: PRINT USING M\$; N

Wherever a **USING** verb is used, it will control the format of all output until a new **USING** verb is encountered.

### Numeric Masks

A numeric **USING** mask may only be used to display numeric values, i.e., numeric constants or numeric variables. If a string constant or variable is displayed while a numeric **USING** mask is in effect, the mask will be ignored. A value which is to be displayed must always fit within the space provided by the mask. The mask must reserve space for the sign character, even when the number will always be positive. Thus a mask which shows four display positions may only be used to display numbers with three digits.



## Specifying Number of Digits

The desired number of digits is specified using the '#' character. Each '#' in the mask reserves space for one digit. The display or print always contains as many characters as are designated in the mask. The number appears to the far right of this field; the remaining positions to the left are filled with spaces. Positive numbers therefore always have at least one space at the left of the field. Since the PC-1245 maintains a maximum of 10 significant digits, no more than 11 '#' characters should be used in a numeric mask.

**NOTE:** In all examples in this appendix the beginning and end of the displayed field will be marked with a '|' character to show the size of the field.

| <u>Statement</u> | <u>Display</u>                                                                                                                 |
|------------------|--------------------------------------------------------------------------------------------------------------------------------|
| 10: USING "####" | (Set the PC-1245 to the RUN position, type RUN, and press <span style="border: 1px solid black; padding: 2px;">ENTER</span> .) |
| 20: PRINT 25     | 25                                                                                                                             |
| 30: PRINT -350   | -350                                                                                                                           |
| 40: PRINT 1000   | ERROR 7 IN 40                                                                                                                  |

Notice that the last statement produced an error because 5 positions (4 digits and a sign space) were required, but only 4 were provided in the mask.

## Specifying a Decimal Point

A decimal point character, '.', may be included in a numeric mask to indicate the desired location of the decimal point. If the mask provides fewer significant decimal digits than are required for the value to be displayed, the remaining positions to the right will be filled with zeros. If there are more significant decimal digits in the value than in the mask, the extra digits will be truncated (not rounded):

| <u>Statement</u>    | <u>Display</u> |
|---------------------|----------------|
| 10: USING "####.##" |                |
| 20: PRINT 25        | 25.00          |
| 30: PRINT -350.5    | -350.50        |
| 40: PRINT 2.547     | 2.54           |

### Specifying Scientific Notation

A " ^ " character may be included in the mask to indicate that the number is to be displayed in scientific notation. The '#' and '.' characters are used in the mask to specify the format of the "characteristic" portion of the number, i.e., the part which is displayed to the left of the E. Two '#' characters should always be used to the left of the decimal point to provide for the sign character and one integer digit. The decimal point may be included, but is not required. Up to 9 '#' characters may appear to the right of the decimal point. Following the characteristic portion, the exponentiation character, E, will be displayed followed by one position for the sign and two positions for the exponent. Thus, the smallest scientific notation field would be provided by a mask of "##^" which would print numbers of the form ' 2 E 99'. The largest scientific notation field would be "##.#####^" which would print numbers such as '-1.234567890 E-12':

| <u>Statement</u>    | <u>Display</u> |
|---------------------|----------------|
| 10: USING "###.##^" |                |
| 20: PRINT 2         | 2. 00 E 00     |
| 30: PRINT -365.278  | -3. 65 E 02    |

promsoft.com

## Specifying Alphanumeric Masks

String constants and variables are displayed using the '&' character. Each '&' indicates one character in the field to be displayed. The string will be positioned at the left end of this field. If the string is shorter than the field, the remaining spaces to the right will be filled with spaces. If the string is longer than the field, the string will be truncated to the length of the field:

| <u>Statement</u>      | <u>Display</u> |
|-----------------------|----------------|
| 10: USING "&&&&&&&"   |                |
| 20: PRINT "ABC"       | A B C          |
| 30: PRINT "ABCDEFGHI" | A B C D E F    |

## Mixed Masks

In most applications a USING mask will contain either all numeric or all string formatting characters. Both may be included in one USING mask, however, for certain purposes. In such cases, each switch from numeric to string formatting characters or vice versa marks the boundary for a different value. Thus, a mask of "#####&&&&" is a specification for displaying two separate values – a numeric value which is allocated 5 positions and a string value which is allocated 4 positions:

| <u>Statement</u>                     | <u>Display</u> |
|--------------------------------------|----------------|
| 10: PRINT USING "###.##&&"; 25; "CR" | 25. 00CR       |
| 20: PRINT -5.789; "DB"               | -5. 78DB       |

**Remember:** Once specified, a USING format is used for all output which follows until cancelled or changed by another USING verb.

### Precaution for using the program on the PC-1251

Although the BASIC statements of the PC-1245 are identical to those of the PC-1251, the number of display columns differ. As a result, when programs created for the PC-1251 are executed on the PC-1245, problems may occur in the statements related to the display such as "PRINT", "PAUSE", "INPUT", etc. Therefore in these instances, the programs must be modified.

1. When the total number of columns exceed 16 with a USING format in the PRINT expression, ERROR 7 results.

Example: 10: USING "#####.#####"

17 columns or more

20: PRINT A

Note: When the total number of columns specified in the integer part exceed 11 including sign digit, the excess part is ignored. Also when the total number of columns of the integer part specified exceed 11, this integer part is regarded as 11 digits in the PC-1245.

Examples:

1) 10: USING "#####.#####"

This format does not cause the error.

2) 10: USING "#####.####"

This format does not also cause the error.

Integer part: 11 digits, Decimal point: 1 digit and Decimal part: 4 digits

Total: 16 digits (less than 17 digits)

3) 10: USING "#####.#####"

This format cause the error 7.

(Total digits are greater than 16 digits.)

- Change the USING format to within 16 columns.

2. When the integer part exceeds 8 columns with a USING format in the PRINT expression, expression, ERROR 7 results.

Example: 10: USING "#####.##"  
9 columns or more

20: PRINT A, B

- Change the USING format to within 8 columns.
3. When a message of the form INPUT " . . . . ."; A exceeds 15 columns, the beginning part of the message is not displayed.
- Shorten the message.
4. When the display contents of the form PRINT expression ; expression ; expression ; . . . . . exceeds 16 columns, when the character string of the expression in the form of PRINT expression , expression exceeds 8 columns, or when a message of the form INPUT " . . . . .", A exceeds 16 columns, the excess part is not displayed.
- Rewrite so that it fit.

## APPENDIX D EXPRESSION EVALUATION AND OPERATOR PRIORITY

When the SHARP PC-1245 is given a complex expression, it evaluates the parts of the expression in a sequence which is determined by the priority of the individual parts of the expression. If you enter the expression:

$$100 / 5 + 45$$

as either a calculation or as a part of a program, the PC-1245 does not know if you meant:

$$\frac{100}{5 + 45} = 2 \quad \text{or} \quad \frac{100}{5} + 45 = 65$$

Since the PC-1245 must have some way to decide between these options, it uses its rules of operator priority. Because division has a higher "priority" than addition (see below), it will choose to do the division first and then the addition, i.e., it will choose the second option and return a value of 65 for the expression.

## Operator Priority

Operators on the SHARP PC-1245 are evaluated with the following priorities from highest to lowest:

1. Parentheses
2. Variables and Pseudovariables
3. Exponentiation (^) when preceded by a multiplication which omits the operator
4. Multiplication which omits the operator
5. Functions
6. Exponentiation (^)
7. Unary minus, negative sign (-)
8. Multiplication and division (\*, /)
9. Addition and subtraction (+, -)
10. Relational operators (<, <=, =, <>, >=, >)
11. Logical operators (AND, OR)

The fourth item refers to usage such as  $2A$  or  $5C(2)$  in which a multiplication operator is implied, but not shown. The third refers to the combination of this with exponentiation, such as  $3A^3$  or  $5D^{1.5}$ . In these combined cases the exponentiation will be done first and the multiplication second.

When there are two or more operators at the same priority level the expression will be evaluated from left to right. (The exponentiation will be evaluated from right to left). Note that with  $A+B-C$ , for example, the answer is the same whether the addition or the subtraction is done first.

When an expression contains multiple nested parentheses, the innermost set is evaluated first and evaluation then proceeds outward.

**Sample Evaluation**

Starting with the expression:

$$( (3+5-2)*6+2) / 10 ^ \text{LOG } 100$$

The **PC-1245** would first evaluate the innermost set of parentheses. Since '+' and '-' are at the same level it would move from left to right and would do the addition first:

$$( (8-2)*6+2) / 10 ^ \text{LOG } 100$$

Then it would do subtraction:

$$( (6)*6+2) / 10 ^ \text{LOG } 100$$

or:

$$(6*6+2) / 10 ^ \text{LOG } 100$$

In the next set of parentheses it would do the multiplication first:

$$(36+2) / 10 ^ \text{LOG } 100$$

And then the addition:

$$(38) / 10 ^ \text{LOG } 100$$

or:

$$38 / 10 ^ \text{LOG } 100$$

Now that the parentheses are cleared, the LOG function has the highest priority so it is done next:

$$38 / 10 ^ 2$$

The exponentiation is done next:

$$38 / 100$$

And last of all the division is performed:

$$0.38$$

This is the value of the expression.

## APPENDIX E FEATURE COMPARISON OF THE PC-1211, PC-1245, PC-1251, AND PC-1500

The four SHARP pocket computers, the PC-1211, the PC-1245, the PC-1251, and the PC-1500 have many features in common, but are some significant differences. Sometimes the same features are present, yet act in a slightly different fashion. In order to facilitate the use of programs on different models the following comparison charts are provided.

### Verbs and Commands

In the following chart the symbol:

- M indicates that the feature can only be used in manual execution, i.e., as a command;
- P indicates that the feature can only be used within a program;
- B indicates that the feature can be used in both contexts.

When no symbol is shown, the feature is not available on that machine

|        | PC-1211 | PC-1245<br>PC-1251 | PC-1500 | Comments                      |
|--------|---------|--------------------|---------|-------------------------------|
| AREAD  | P       | P                  | P       | See Note 1                    |
| ARUN   |         |                    | P       |                               |
| BEEP   | P       | B                  | B       |                               |
| CHAIN  |         |                    |         | PC-1500 has tone and duration |
| CLEAR  | P       | P                  | P       |                               |
| CLOAD  | B       | B                  | B       |                               |
| CLOAD? | M       | M                  | M       |                               |
| CLS    |         |                    | M       |                               |
| COLOR  |         |                    | B       |                               |
| CONT   |         |                    | B       |                               |
| CSAVE  | M       | M                  | M       |                               |
| Csize  | M       | B                  | B       |                               |
| CURSOR |         |                    | B       |                               |
| DEGREE |         |                    | B       |                               |
| DATA   | B       | B                  | B       |                               |
|        |         | P                  | P       |                               |



Verbs and Commands (continued)

|                     | PC-1211 | PC-1245<br>PC-1251 | PC-1500 | Comments                      |
|---------------------|---------|--------------------|---------|-------------------------------|
| DEBUG               | M       |                    |         |                               |
| DIM                 |         | B                  | B       |                               |
| END                 | P       | P                  | P       |                               |
| FOR ... TO ... STEP | P       | P                  | P       |                               |
| GOSUB               | P       | P                  | P       |                               |
| GOTO                | P       | B                  | B       |                               |
| GCURSOR             |         |                    | B       |                               |
| GPRINT              |         |                    | B       |                               |
| GRAD                | B       | B                  | B       |                               |
| GRAPH               |         |                    | B       |                               |
| IF ... THEN         | P       | P                  | P       |                               |
| INPUT               | P       | P                  | P       |                               |
| INPUT #             | B       | B                  | B       |                               |
| LET                 | P       | P                  | P       |                               |
| LF                  |         |                    | B       |                               |
| LINE                |         |                    | B       |                               |
| LIST                | M       | M                  | M       |                               |
| LLIST               |         | M                  | M       | PC-1211 can emulate with LIST |
| LOCK                |         |                    | B       |                               |
| LPRINT              |         | P                  | B       | See Note 2                    |
| MERGE               | M       | M                  | M       |                               |
| NEW                 | M       | M                  | M       |                               |
| NEXT                | P       | P                  | P       |                               |
| ON ... ERROR        |         |                    | P       |                               |
| ON ... GOSUB        |         | P                  | P       |                               |
| ON ... GOTO         |         | P                  | P       |                               |
| PAUSE               | P       | P                  | P       |                               |
| PASS                |         | M                  |         |                               |
| PRINT               | P       | P                  | B       | See Note 2                    |
| PRINT #             | B       | B                  | B       |                               |
| RADIAN              | B       | B                  | B       |                               |
| RANDOM              |         | B                  | B       |                               |
| READ                |         | P                  | P       |                               |
| REM                 | P       | P                  | P       |                               |

**Verbs and Commands (continued)**

|         | PC-1211 | PC-1245<br>PC-1251 | PC-1500 | Comments   |
|---------|---------|--------------------|---------|------------|
| RESTORE |         | P                  | P       |            |
| RETURN  | P       | P                  | P       |            |
| RLINE   |         |                    | B       |            |
| RMTOFF  |         |                    | B       |            |
| RMTON   |         |                    | B       |            |
| ROTATE  |         |                    | B       |            |
| RUN     |         |                    | B       |            |
| SORGN   | M       | M                  | M       |            |
| STOP    | P       | P                  | B       |            |
| TAB     |         |                    | P       |            |
| TEST    |         |                    | B       |            |
| TEXT    |         |                    | B       |            |
| TROFF   |         |                    | B       |            |
| TRON    |         | B                  | B       |            |
| UNLOCK  |         | B                  | B       |            |
| USING   |         |                    | B       |            |
| WAIT    | P       | B                  | B       | See Note 3 |
|         |         | B                  | B       |            |

Note 1: There are some minor differences between the PC-1245/1251 and the PC-1211 in the behavior of AREAD following PRINT, but these are unlikely to cause problems in ordinary usage.

Note 2: Add PRINT = LPRINT and PRINT = PRINT statements to PC-1211 programs to achieve the desired results on the PC-1245/1251.

Note 3: On the PC-1211 the USING format applies to all displays on the line in which the USING clause appears, even if the variable precedes the verb. On the other models, the USING format applies only to displays which follow the verb and remains in effect until cancelled by another USING verb.

Example:

```
10 A = -123.456
20 PAUSE USING "####.##"; A
30 PAUSE A, USING "####"; A
```

When executed, this program displays the following:

- PC-1211
 

|  |         |
|--|---------|
|  | -123.45 |
|  | -123    |
- PC-1245/1251
 

|  |         |
|--|---------|
|  | -123.45 |
|  | -123.45 |
|  | -123    |

### Pseudovariables

In this and the following charts the features are simply marked with a 'Y' when the machine has the feature.

|             | PC-1211 | PC-1245<br>PC-1251 | PC-1500 | Comments               |
|-------------|---------|--------------------|---------|------------------------|
| INKEY\$     |         | Y                  | Y       | PC-1211 has only $\pi$ |
| MEM         | Y       | Y                  | Y       |                        |
| PI or $\pi$ | Y       | Y                  | Y       |                        |
| TIME        |         |                    | Y       |                        |

### Numeric Functions

|                       | PC-1211 | PC-1245<br>PC-1251 | PC-1500 | Comments                        |
|-----------------------|---------|--------------------|---------|---------------------------------|
| ABS                   | Y       | Y                  | Y       | PC-1211 has only $\sqrt{\quad}$ |
| ACS                   | Y       | Y                  | Y       |                                 |
| ASN                   | Y       | Y                  | Y       |                                 |
| ATN                   | Y       | Y                  | Y       |                                 |
| COS                   | Y       | Y                  | Y       |                                 |
| DEG                   | Y       | Y                  | Y       |                                 |
| DMS                   | Y       | Y                  | Y       |                                 |
| EXP                   | Y       | Y                  | Y       |                                 |
| INT                   | Y       | Y                  | Y       |                                 |
| LOG                   | Y       | Y                  | Y       |                                 |
| LN                    |         | Y                  | Y       |                                 |
| NOT                   |         |                    | Y       |                                 |
| POINT                 |         |                    | Y       |                                 |
| RND                   |         | Y                  | Y       |                                 |
| SGN                   | Y       | Y                  | Y       |                                 |
| SIN                   | Y       | Y                  | Y       |                                 |
| SQR or $\sqrt{\quad}$ | Y       | Y                  | Y       |                                 |
| STATUS                |         |                    | Y       |                                 |
| TAN                   | Y       | Y                  | Y       |                                 |

**APPENDIX E**  
**Feature Comparison**

**String Functions**

|         | PC-1211 | PC-1245<br>PC-1251 | PC1500 | Comments |
|---------|---------|--------------------|--------|----------|
| ASC     |         | Y                  | Y      |          |
| CHR\$   |         | Y                  | Y      |          |
| LEFT\$  |         | Y                  | Y      |          |
| LEN     |         | Y                  | Y      |          |
| MID\$   |         | Y                  | Y      |          |
| RIGHT\$ |         | Y                  | Y      |          |
| STR\$   |         | Y                  | Y      |          |
| VAL     |         | Y                  | Y      |          |

**Operators**

|                     | PC-1211 | PC-1245<br>PC-1251 | PC-1500 | Comments |
|---------------------|---------|--------------------|---------|----------|
| ^                   | Y       | Y                  | Y       |          |
| *, /, +, -          | Y       | Y                  | Y       |          |
| >, >=, =, <>, <=, < | Y       | Y                  | Y       |          |
| AND, OR,            |         | Y                  | Y       |          |
| &                   |         | Y                  | Y       |          |

# APPENDIX F NUMERIC PRECISION ON THE PC-1245

## Accuracy in Computations

While the PC-1245 displays the results of calculations to an accuracy of 10 digits, 12 digits are used internal in calculations to provide addition accuracy. For example:  $5/9$  yields  $5.5555555555E-01$

internally which is rounded to the 10th digit and displayed externally as  
 $5.555555556E-01$

Similarly,

$5/9 * 9$  yields  $4.9999999999E 00$

internally and when this is rounded to 10 digits externally, the display will show  
5.

This is particularly significant with exponentiation as calculations are performed using logarithms

$$A \wedge B \text{ is computed by } 10^{B \log A}$$

These factors can result in small differences between calculations performed in different ways and can cause comparisons to yield different results depending on whether the internal or external form is used for the comparison.

For example,  $3^2 - 9$  could either be calculated in one step or two. If it is done in two steps the PC-1245 computes

$3 \wedge 2$  yielding 9.

and  $-9$  yielding 0.

as we would expect. But if the calculation is performed in one step, the PC-1245 will calculate

$3 \wedge 2 - 9$  yielding  $-9.E-11$

due to the difference between the number calculated for  $3 \wedge 2$  at 12 digit accuracy ( $8.99999999991E 00$ ) and the exact value of 9. The rounding which occurred in the two step calculation concealed this difference in the same way that  $(5/9) * 9$  became 5 in the display, even though the internal value was slightly lower.

One place this can be very significant is in making comparisons in IF statements. If the variable A has been given the value of 3, the statement.

30: IF  $A \wedge 2 >= 9$  THEN GOTO 50

Will **not** cause a branch to 50 because the internal value will be used in the comparison and this is slightly below 9. But if the program is

20: B =  $A \wedge 2$

30: IF  $B >= 9$  THEN GOTO 50

**APPENDIX F**  
**Numeric Precision**

the branch would occur because the rounding would have occurred when the value was assigned to B.

**Special Limits**

In addition to the general limits described above and in Chapter 4, certain functions of the PC-1245 have their own special limits. These are shown in the chart below.

| Functions                                                      | Dynamic range                                                                                                                                                                                                                                                                                                                                                            |
|----------------------------------------------------------------|--------------------------------------------------------------------------------------------------------------------------------------------------------------------------------------------------------------------------------------------------------------------------------------------------------------------------------------------------------------------------|
| $y \wedge x$<br>( $y^x$ )                                      | $-1 \times 10^{100} < x \log y < 100$<br>$\left( \begin{array}{l} y=0, x \leq 0: \text{ERROR 2} \\ y=0, x > 0: 0 \\ y < 0, x \neq \text{integer}: \text{ERROR 2} \end{array} \right)$ (Ex.) $0 \wedge 0$ <b>ENTER</b> → ERROR 2<br>$0 \wedge 5$ <b>ENTER</b> → 0.<br>$(-4) \wedge 0.5$ <b>ENTER</b> → ERROR 2<br>The value of Y can be negative only if X is an integer. |
| SIN x<br>COS x<br>TAN x                                        | DEG: $ x  < 1 \times 10^{10}$<br>RAD: $ x  < \frac{\pi}{180} \times 10^{10}$<br>GRAD: $ x  < \frac{10}{9} \times 10^{10}$<br>In TAN x, however, the following cases are excluded.<br>DEG: $ x  = 90(2n-1)$<br>RAD: $ x  = \frac{\pi}{2}(2n-1)$<br>GRAD: $ x  = 100(2n-1)$<br>(n: integer)                                                                                |
| ASN x ( $\text{SIN}^{-1} x$ )<br>ACS x ( $\text{COS}^{-1} x$ ) | $-1 \leq x \leq 1$                                                                                                                                                                                                                                                                                                                                                       |
| ATN x ( $\text{TAN}^{-1} x$ )                                  | $ x  < 1 \times 10^{100}$                                                                                                                                                                                                                                                                                                                                                |
| LN x<br>LOG x                                                  | $1 \times 10^{-99} \leq x < 1 \times 10^{100}$                                                                                                                                                                                                                                                                                                                           |
| EXP x                                                          | $-1 \times 10^{100} < x \leq 230.2585092$                                                                                                                                                                                                                                                                                                                                |
| $\sqrt{x}$                                                     | $0 \leq x < 1 \times 10^{100}$                                                                                                                                                                                                                                                                                                                                           |

Functions other than those shown above can be calculated only when x stays within the following range.

$$1 \times 10^{-99} \leq |x| < 1 \times 10^{100} \text{ and } 0$$

As a rule, the error of functional calculations is less than  $\pm 1$  at the lowest digit of a displayed numerical value (at the lowest digit of mantissa in the case of scientific notation system) within the above calculation range.

# APPENDIX G SPECIFICATIONS

|                               |                                                                                                                                                                                                                                                             |
|-------------------------------|-------------------------------------------------------------------------------------------------------------------------------------------------------------------------------------------------------------------------------------------------------------|
| <b>Model:</b>                 | PC-1245 Pocket Computer                                                                                                                                                                                                                                     |
| <b>Processor:</b>             | 8 bit CMOS CPU                                                                                                                                                                                                                                              |
| <b>Programming Language:</b>  | BASIC                                                                                                                                                                                                                                                       |
| <b>Memory Capacity:</b>       | System ROM: 24 K Bytes                                                                                                                                                                                                                                      |
|                               | RAM                                                                                                                                                                                                                                                         |
|                               | System About 500 Bytes                                                                                                                                                                                                                                      |
|                               | User                                                                                                                                                                                                                                                        |
|                               | Fixed Memory Area 208 Bytes<br>(A ~ Z, A\$ ~ Z\$)                                                                                                                                                                                                           |
|                               | Program/Data Area 1486 Bytes                                                                                                                                                                                                                                |
| <b>Stack:</b>                 | Sub-routine: 10 stacks Function: 16 stacks<br>FOR-NEXT: 5 stacks Data: 8 stacks                                                                                                                                                                             |
| <b>Operators:</b>             | Addition, subtraction, multiplication, division, exponentiation, trigonometric and inverse trigonometric functions, logarithmic and exponential functions, angle conversion, square root, sign, absolute, integer, relational operators, logical operators. |
| <b>Numeric Precision:</b>     | 10 digits (mantissa) + 2 digits (exponent).                                                                                                                                                                                                                 |
| <b>Editing Features:</b>      | Cursor left and right, line up and down, character insert, character delete.                                                                                                                                                                                |
| <b>Memory Protection:</b>     | CMOS Battery backup.                                                                                                                                                                                                                                        |
| <b>Display:</b>               | 16 character liquid crystal display with 5 x 7 dot characters.                                                                                                                                                                                              |
| <b>Keys:</b>                  | 52 keys: Alphabetic, numeric, special symbols, and functions. Numeric pad. User defined keys.                                                                                                                                                               |
| <b>Power Supply:</b>          | 6.0V DC Lithium cells.<br>Type: CR-2032                                                                                                                                                                                                                     |
| <b>Power Consumption:</b>     | 6.0V DC @ 0.03W<br>Cells are sufficient for approximately 300 hours usage without external power supply.                                                                                                                                                    |
| <b>Operating Temperature:</b> | 0°C ~ 40°C (32°F ~ 104°F).                                                                                                                                                                                                                                  |
| <b>Dimensions:</b>            | 135(W) x 70(D) x 9.5(H) mm.<br>5-5/16"(W) x 2-3/4"(D) x 3/8"(H)                                                                                                                                                                                             |
| <b>Weight:</b>                | Approximately 115g (0.25 lbs.) (with cells)                                                                                                                                                                                                                 |
| <b>Accessories:</b>           | Hard cover, two lithium cells (built-in), keyboard template and instruction manual.                                                                                                                                                                         |
| <b>Options:</b>               | Printer/Microcassette Recorder (CE-125)                                                                                                                                                                                                                     |

promsoft.com



## Program Examples

Probably you have acquired knowledge on a number of program commands as you have proceeded to the function description up to this page. It is necessary, however, to generate actual programs by yourself in addition to the instruction manual, so that you can generate programs freely using BASIC language. Like driving a car or playing tennis that can be improved by actual practice, you can improve your programming only by generating as many programs as possible regardless of your skill. It is also important for you to refer to programs generated by others. For your reference, the following pages contain a variety of programs using BASIC commands.

**(Sharp Corporation and/or its subsidiaries assume no responsibilities or obligations to any losses or damages that could arise through the use of the software programs employed in this instruction manual.)**

### **Notes on the use of the CE-125**

When the PC-1245 is used while connected to printer/microcassette recorder CE-125, the microcassette tape supplied with the CE-125 cannot be used as is. The 20 programs recorded on this tape were developed for the PC-1251. The program contents as well as program lists for 9 of these programs are given in the PC-1251 Instruction Manual and those for the remaining 11 are given in the CE-125 Instruction Manual. The contents of the program in the Program Examples are identical to the programs given in the PC-1251 Instruction Manual. However, after reading a program from the microcassette tape mentioned above, it can be used if certain portions of the program list is modified. **In the Program Examples, the portions which differ from the program lists recorded on the tape are underlined.**

Furhter, when reading a program given in the CE-125 Instruction Manual from the tape, the portions to be modified are summarized at the end of the Program Examples and can be used for reference.

# CONTENTS

| (program title)                                             | (page) |
|-------------------------------------------------------------|--------|
| ● NEWTON'S METHOD FOR FINDING ROOTS OF EQUATIONS. ....      | 161    |
| ● AVERAGE, VARIANCE AND STANDARD DEVIATION .....            | 165    |
| ● INTERSECTION BETWEEN CIRCLES AND STRAIGHT LINES .....     | 170    |
| ● NUMBER OF DAYS CALCULATION .....                          | 175    |
| ● TYPING PRACTICE .....                                     | 179    |
| ● SOFTLANDING GAME .....                                    | 183    |
| ● MEMORY CHECKER .....                                      | 187    |
| ● BUGHUNT .....                                             | 192    |
| ● DOUBLE ROTATION. ....                                     | 197    |
| ● Modification Summary of the CE-125 Program Examples ..... | 201    |

## Showing the bytes used in each program

The number of bytes used in each program is shown at the end of each program listing.

The way to find this out is as follows:

at RUN position

1) CLEAR

2) 1486 – MEM **ENTER** → number of bytes.

# Program Title: NEWTON'S METHOD FOR FINDING ROOTS OF EQUATIONS

## OVERVIEW (mathematical)

Finding the roots of equations is usually troublesome, but by using Newton's Method the approximate roots of equations can be found.

When 1 root is found, depending on the interval width, by using Newton's Method the starting point automatically changes.

## CONTENTS

$$X_{n+1} = X_n - \frac{f(X_n)}{f'(X_n)}$$

If the absolute value of the distance between  $X_n$  and  $X_{n+1}$  is less than  $10^{-8}$ ,  $X_n$  is considered a root and is displayed. Here the first derivative is defined in the following way:

$$f'(X) = \frac{f(X+h) - f(X)}{h} \quad (h \text{ is the minute interval})$$

Change E-8 in line 340 to change the value for  $10^{-8}$ .

## INSTRUCTIONS

### INPUT

- Starting point
- Minute interval
- Interval

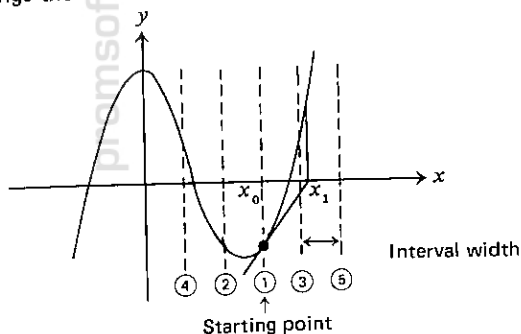

### OUTPUTS

Root value (by pressing the **ENTER** key, the next interval's root is found)

## EXAMPLE

$$x^3 - 2x^2 - x + 2 = 0 \quad (\text{the roots are } -1, 1, 2)$$

starting point = 0

minute interval =  $10^{-4}$

interval = 0.5

The above values are used in the calculation.

The functions are to be written into lines after 500 as subroutines.

How to type in the example:

1. Go into PRO mode by operating the mode change key.
2.  $500B = ((X-2) * X-1) * X+2$  **ENTER**  
 $510$  RETURN **ENTER** That is all that had to be done.

## KEY OPERATION SEQUENCE

| Step No. | Key Input             | Display            | Remarks                                                                             |
|----------|-----------------------|--------------------|-------------------------------------------------------------------------------------|
| 1        | <b>DEF</b> <b>A</b>   | STARTING POINT = _ | Waiting for starting point input                                                    |
| 2        | $0$ <b>ENTER</b>      | MINUTE INTV. = _   | Waiting for minute interval input                                                   |
| 3        | $0.0001$ <b>ENTER</b> | INTERVAL = _       | Waiting for interval width input                                                    |
| 4        | $0.5$ <b>ENTER</b>    |                    | 2. Display of roots                                                                 |
| 5        | <b>ENTER</b>          |                    | 1. By repeatedly pressing the <b>ENTER</b> key the roots of the function are found. |
| 6        | <b>ENTER</b>          |                    | -1.                                                                                 |
| 7        | <b>ENTER</b>          |                    | 1.                                                                                  |
| 8        | <b>ENTER</b>          |                    | -1.                                                                                 |
| 9        | <b>ENTER</b>          |                    | -1.                                                                                 |
| 10       | <b>ENTER</b>          |                    | -1.                                                                                 |
| 11       | <b>ENTER</b>          |                    | 2.                                                                                  |
|          | ⋮                     | ⋮                  |                                                                                     |
|          | ⋮                     | ⋮                  |                                                                                     |

# FLOWCHART

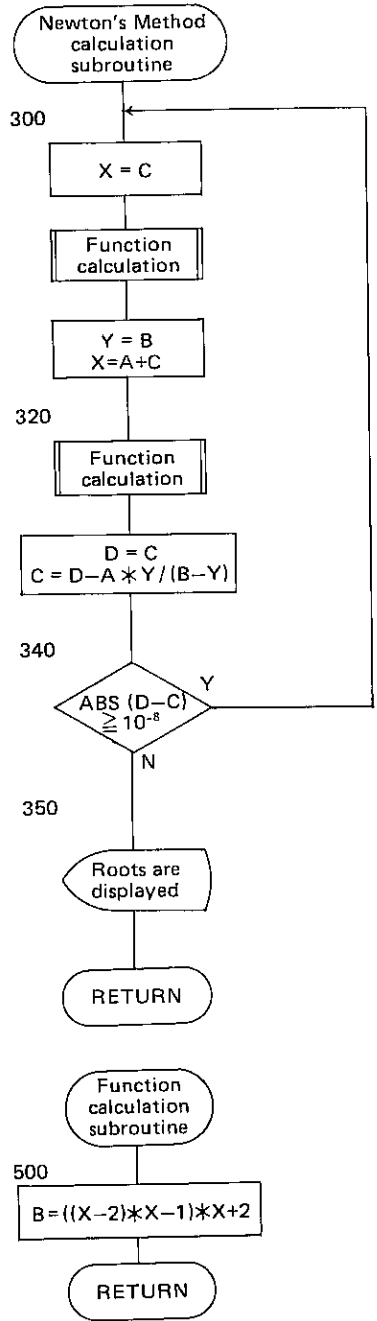
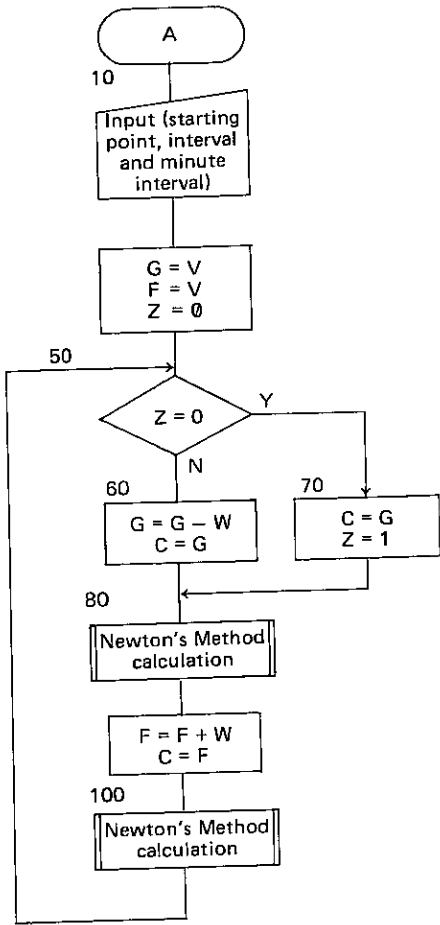

promsoft.com

## PROGRAM LIST

```

10:"A": INPUT "STARTING
 POINT=";V
20:INPUT "MINUTE INTV.="
 ;A
30:INPUT "INTERVAL=";W
40:G=V:F=Y:Z=0
50:IF Z=0 GOTO 70
60:G=G-W:C=G: GOTO 80
70:C=G:Z=1
80:GOSUB 300
90:F=F+W:C=F
100:GOSUB 300
110:GOTO 50
120:END
300:X=C: GOSUB 500
310:Y=B:X=A+C
320:GOSUB 500
330:D=C:C=D-A*Y/(B-Y)
340:IF ABS (D-C)>=E-8
 GOTO 300
350:BEEP 3: PRINT C
360:RETURN
500:B=((X-2)*X-1)*X+2
510:RETURN

```

255

## MEMORY CONTENTS

|   |                 |
|---|-----------------|
| A | Minute interval |
| B | $f(x)$          |
| C | $X_0$           |
| D | $f(x+h)$        |
| E |                 |
| F | ✓               |
| G | ✓               |
| H |                 |
| I |                 |
| J |                 |
| K |                 |
| L |                 |
| M |                 |
| N |                 |
| O |                 |
| P |                 |
| Q |                 |
| R |                 |
| S |                 |
| T |                 |
| U |                 |
| V | Starting point  |
| W | Interval        |
| X | $x$             |
| Y | $f(x)$          |
| Z | Initial flag    |

Program Title: **AVERAGE, VARIANCE AND STANDARD DEVIATION**

## OVERVIEW

If the data are input, the total sum, average, variance, and standard deviation will be calculated for you. Revision of input data as well as data with weights is possible.

## CONTENTS

Total sum  $\Sigma x_i \cdot f_i$

Standard deviation  $\sigma = \sqrt{\sigma^2}$

Average  $\bar{x} = \frac{\Sigma x_i \cdot f_i}{\Sigma f_i}$

Variance  $\sigma^2 = \frac{\Sigma (x_i - \bar{x}) f_i}{\Sigma f_i - 1}$

Number of data entries (up to 50)

(when there are no weights  $f_i = 1$ )

## INSTRUCTIONS

1. At **DEF** **A**, select whether or not there are any weights, then input the data.
2. **DEF** **B** is used to find any revision positions in the data. **DEF** **C** is used to revise the data.
3. The total sum, average, variance, and standard deviation will be calculated with **DEF** **D**.

## EXAMPLE

|       |      |      |      |      |      |
|-------|------|------|------|------|------|
| $x_i$ | 14.1 | 14.2 | 14.3 | 14.4 | 14.5 |
| $f_i$ | 8    | 19   | 23   | 15   | 10   |

(data with weights)

# KEY OPERATION SEQUENCE

| Step No. | Key Input           | Display                      | Remarks                                          |
|----------|---------------------|------------------------------|--------------------------------------------------|
| 1        | <b>DEF</b> <b>A</b> | NO. OF DATA = _              | Waiting for number of data input                 |
| 2        | 5 <b>ENTER</b>      | WEIGHTS<br>YES = 1/NO = 2? _ | Waiting for the selection of weights/no weights. |
| 3        | 1 <b>ENTER</b>      | X (1) =<br>?                 |                                                  |
| 4        | 14.1 <b>ENTER</b>   | F (1) =<br>?                 |                                                  |
| 5        | 8 <b>ENTER</b>      | X (2) =<br>?                 |                                                  |
|          | ⋮                   | ⋮                            |                                                  |
| 12       | 14.5 <b>ENTER</b>   | F (5) =<br>?                 |                                                  |
| 13       | 10 <b>ENTER</b>     | >                            | End of the process                               |



# KEY OPERATION SEQUENCE

| Step No. | Key Input           | Display            | Remarks                                                                            |
|----------|---------------------|--------------------|------------------------------------------------------------------------------------|
| 1        | <b>DEF</b> <b>B</b> | X (1) = 14.1       |                                                                                    |
| 2        | <b>ENTER</b>        | F (1) = 8          |                                                                                    |
| 3        | <b>ENTER</b>        | X (2) = 14.1       | <b>DEF</b> <b>C</b> is used to input the revised values when data errors are found |
| 4        | <b>DEF</b> <b>C</b> | X (2) =            |                                                                                    |
|          |                     | REVISION VALUE = _ | Revised value is input                                                             |
| 5        | 14.2 <b>ENTER</b>   | F (2) = 19         |                                                                                    |
|          | <b>ENTER</b>        |                    |                                                                                    |
|          |                     | ⋮                  |                                                                                    |
|          |                     | ⋮                  |                                                                                    |
| 1        | <b>DEF</b> <b>D</b> | TOTAL SUM          |                                                                                    |
| 2        | <b>ENTER</b>        | 1072.5             |                                                                                    |
| 3        | <b>ENTER</b>        | MEAN VALUE         |                                                                                    |
| 4        | <b>ENTER</b>        | 14.3               |                                                                                    |
| 5        | <b>ENTER</b>        | VARIANCE           |                                                                                    |
| 6        | <b>ENTER</b>        | 1.432432432E-02    |                                                                                    |
| 7        | <b>ENTER</b>        | STD. DEV.          | Display of standard deviation                                                      |
| 8        | <b>ENTER</b>        | 1.196842683E-01    |                                                                                    |
| 9        | <b>ENTER</b>        | >                  | Processing finished                                                                |

# FLOWCHART

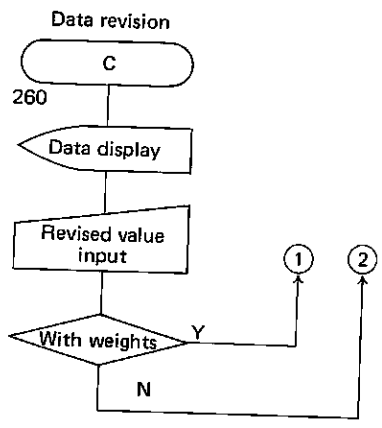
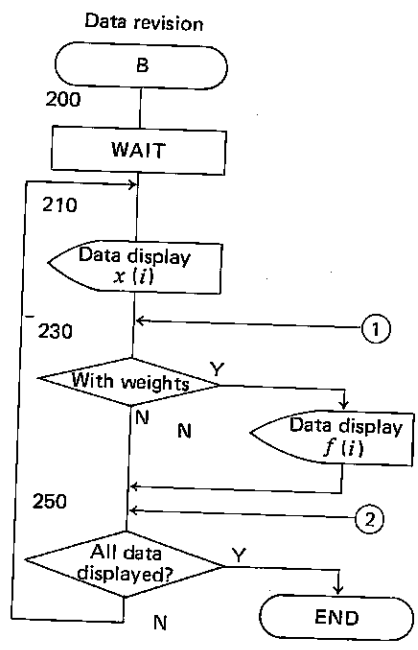
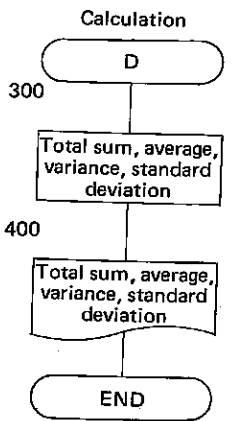
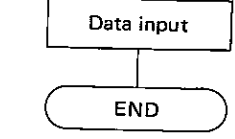
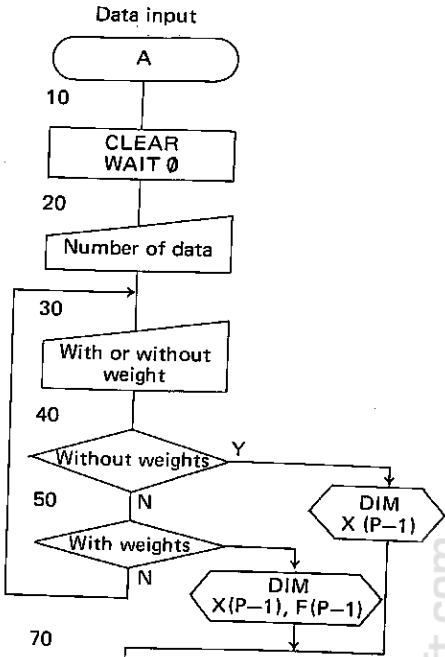

# PROGRAM LIST

```

10:"A": CLEAR : WAIT 0
20:INPUT "NO. OF DATA="
 :P
30:WAIT 60: PRINT "WEIG
HTS": INPUT "YES=I/N
Q=2 ? ":A: WAIT
40:IF A=2 DIM X(P-1):
 GOTO 70
50:IF A=1 DIM X(P-1),F(
P-1): GOTO 70
60:GOTO 30
70:FOR I=0 TO P-1
80:B$="X(" + STR$ (I+1)+
 ")="
85:PAUSE B$: INPUT X(I)
 : GOTO 100
90:GOTO 85
100:IF A=2 GOTO 150
120:B$="F(" + STR$ (I+1)+
 ")="
130:PAUSE B$: INPUT F(I)
 : GOTO 150
140:GOTO 130
150:NEXT I: END
200:"B": WAIT :I=0
210:B$="X(" + STR$ (I+1)+
 ")=":J=1: PRINT B$:X
(I)
230:IF A=1 LET B$="F(" +
 STR$ (I+1)+")=":
 PRINT B$:F(I):J=2
240:I=I+1
250:IF I=P END
255:GOTO 210
260:"C": PAUSE B$: IF
 LEFT$ (B$,1)="X"
 INPUT "REVISION VALU
E=":X(I): GOTO 290
270:IF LEFT$ (B$,1)="F"
 INPUT "REVISION VALU
E=":F(I): GOTO 290
280:GOTO 250
290:IF J=1 GOTO 230
291:GOTO 210
300:"D":N=0:T=0:S=0: FOR
 I=0 TO P-1:X=X(I)
305:F=1: IF A=1 LET F=F(
 I)
310:N=N+X:F=T+F*X:S=S+F*
 X*X: NEXT I
400:WAIT :X=T/N:Q=(S-N*X
 *X)/(N-1):S=SQ:
 PRINT "TOTAL SUM":
 PRINT T: PRINT "MEAN
 VALUE": PRINT X

```

```

410:PRINT "VARIANCE":
 PRINT Q: PRINT "STD.
 DEV.": PRINT S: END

```

649

# MEMORY CONTENTS

|         |                    |
|---------|--------------------|
| A       | ✓                  |
| B\$     | ✓                  |
| C       |                    |
| D       |                    |
| E       |                    |
| F       | ✓                  |
| G       |                    |
| H       |                    |
| I       | ✓                  |
| J       | Flag               |
| K       |                    |
| L       |                    |
| M       |                    |
| N       | ✓                  |
| O       |                    |
| P       | Data number        |
| Q       | Variance           |
| R       |                    |
| S       | Standard deviation |
| T       | Total sum          |
| U       |                    |
| V       |                    |
| W       |                    |
| X       | Average            |
| Y       |                    |
| Z       |                    |
| X (P-1) | Data               |
| F (P-1) | Data               |

**Program Title: INTERSECTION BETWEEN CIRCLES AND STRAIGHT LINES**

**OVERVIEW**

The points of intersection between circles and straight lines in the X-Y plane are found.

**CONTENTS**

The 2 points of intersection between a circle and a straight line are P and Q.

(Note) The angles are in degrees, minutes, and seconds and are to be input in the following way:

123.1423 = 123 degrees 14 minutes 23 seconds.

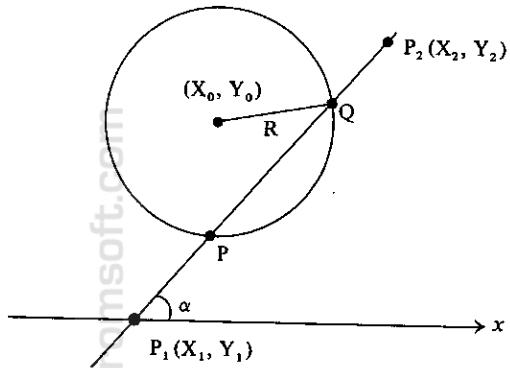

**INSTRUCTIONS**

1. If the straight line is determined by 2 points, **DEF** **A** is used.  
If the line is determined by 1 point and 1 direction angle, **DEF** **B** is used.
2. After the data are input, the results are displayed.

**EXAMPLE**

$X_1 = -50$   
 $Y_1 = 0$   
 $X_2 = 50$      $X_P = 0$   
 $Y_2 = 100$      $Y_P = 50$   
 $X_0 = 50$      $X_Q = 50$   
 $Y_0 = 50$      $Y_Q = 100$   
 $R = 50$   
 $\alpha = 45^\circ$

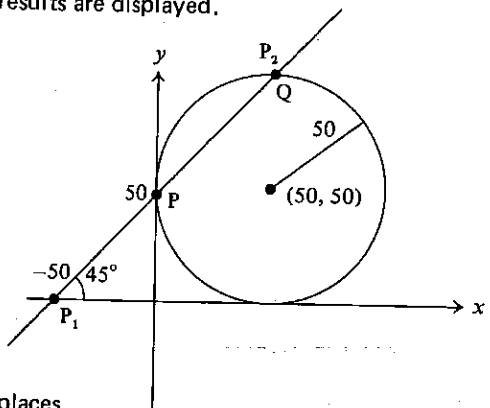

(Note) The coordinate values are accurate up to 5 decimal places.

# KEY OPERATION SEQUENCE

(when 2 points on the line are known)

| Step No. | Key Input | Display      | Remarks      |
|----------|-----------|--------------|--------------|
| 1        | DEF A     | $X0 = \_$    |              |
| 2        | 50 ENTER  | $Y0 = \_$    |              |
| 3        | 50 ENTER  | $R = \_$     |              |
| 4        | 50 ENTER  | $X1 = \_$    |              |
| 5        | -50 ENTER | $Y1 = \_$    |              |
| 6        | 0 ENTER   | $X2 = \_$    |              |
| 7        | 50 ENTER  | $Y2 = \_$    |              |
| 8        | 100 ENTER | P-X 0.0000   | $(x_p, y_p)$ |
| 9        | ENTER     | P-Y 49.9999  |              |
| 10       | ENTER     | Q-X 50.0000  | $(x_q, y_q)$ |
| 11       | ENTER     | Q-Y 100.0000 |              |
| 12       | ENTER     | >            | END          |

(when 1 point on the line and 1 direction angle are known)

| Step No. | Key Input           | Display        | Remarks      |
|----------|---------------------|----------------|--------------|
| 1        | <b>DEF</b> <b>B</b> | $X\theta = \_$ |              |
| 2        | 50 <b>ENTER</b>     | $Y\theta = \_$ |              |
| 3        | 50 <b>ENTER</b>     | $R = \_$       |              |
| 4        | 50 <b>ENTER</b>     | $X1 = \_$      |              |
| 5        | -50 <b>ENTER</b>    | $Y1 = \_$      |              |
| 6        | 0 <b>ENTER</b>      | $A = \_$       |              |
| 7        | 45 <b>ENTER</b>     | P-X 0.0000     | $(x_p, y_p)$ |
| 8        | <b>ENTER</b>        | P-Y 49.9999    |              |
| 9        | <b>ENTER</b>        | Q-X 50.0000    | $(x_q, y_q)$ |
| 10       | <b>ENTER</b>        | Q-Y 100.0000   |              |
| 11       | <b>ENTER</b>        | >              | END          |

# FLOWCHART

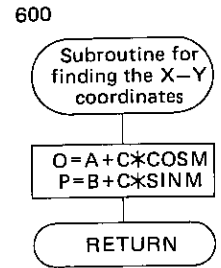
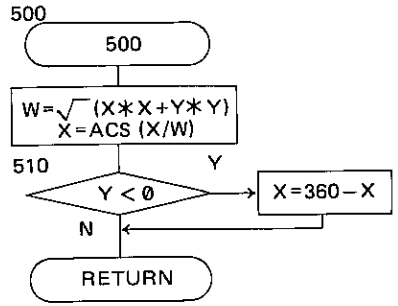
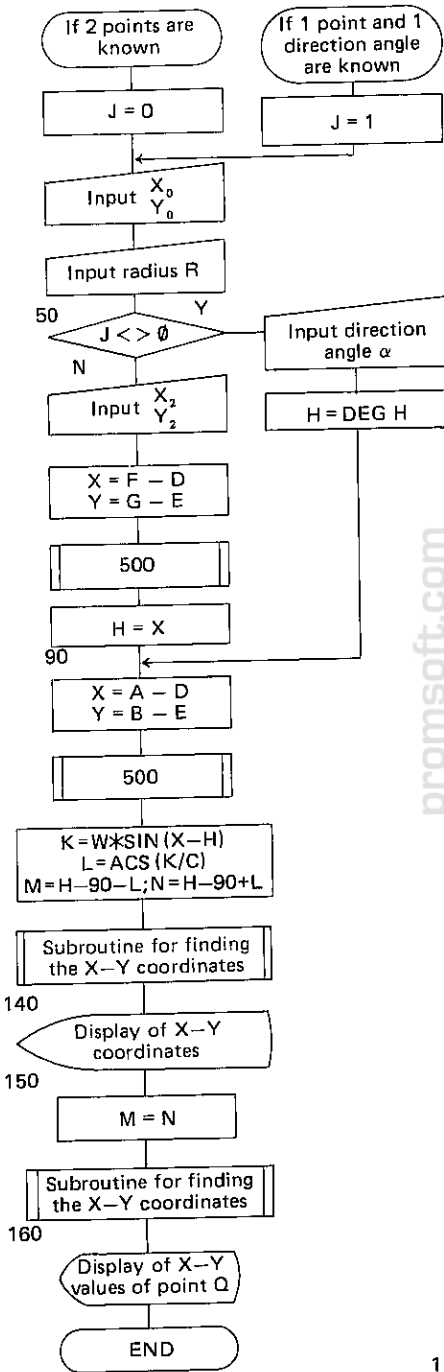

promsoft.com

## PROGRAM LIST

## MEMORY CONTENTS

```

10:"A":J=0: GOTO 30
20:"B":J=1
30:DEGREE : INPUT "X0=
 ";A,"Y0=" ;B,"R=" ;C
40:INPUT "X1=" ;D,"Y1=
 ";E
50:IF J<>0 INPUT "A=" ;
 H:H= DEG H: GOTO 90
60:INPUT "X2=" ;F,"Y2=
 ";G
70:X=F-D:Y=G-E: GOSUB 5
 00
80:H=X
90:X=A-D:Y=B-E: GOSUB 5
 00
100:K=W* SIN (X-H)
110:L= ACS (K/C)
120:M=H-90-L:N=H-90+L
130:GOSUB 600
140:PRINT USING "#####.
 #####";"P-X";0: PRINT
 "P-Y";P
150:M=N: GOSUB 600
160:PRINT "Q-X";0: PRINT
 "Q-Y";P
170:END
500:W=J(X*X+Y*Y)
510:X= ACS (X/W): IF Y<0
 LET X=360-X
520:RETURN
600:O=A+C* COS M:P=B+C*
 SIN M: RETURN
351

```

|   |                    |
|---|--------------------|
| A | $X_0$              |
| B | $Y_0$              |
| C | R                  |
| D | $X_1$              |
| E | $Y_1$              |
| F | $X_2$              |
| G | $Y_2$              |
| H | ✓                  |
| I |                    |
| J | ✓                  |
| K | $h$                |
| L | $\alpha$           |
| M | $Q_P$              |
| N | $Q_Q$              |
| O | $X_P, X_Q$         |
| P | $Y_P, Y_Q$         |
| Q |                    |
| R |                    |
| S |                    |
| T |                    |
| U |                    |
| V |                    |
| W | L                  |
| X | $\Delta X, \theta$ |
| Y | $\Delta Y$         |
| Z |                    |



## Program Title: NUMBER OF DAYS CALCULATION

### OVERVIEW

How many days has it been since you were born?

This program is convenient for answering such questions. By setting a certain day, this program will output the number of days that have passed since that day.

### CONTENTS

#### [Instructions]

**DEF** **A**

BASE YEAR **ENTER**

MONTH **ENTER**

DAY **ENTER**

TARGET YEAR **ENTER**

MONTH **ENTER**

DAY **ENTER**

To end the program, type in **DEF** **Z** in place of the year.

#### [Example]

from 1976 year 10 month 5 day

to 1982 year 6 month 4 day : 2068 days

to 1985 year 1 month 1 day : 3010 days

# KEY OPERATION SEQUENCE

| Step No. | Key Input           | Display      | Remarks                                   |
|----------|---------------------|--------------|-------------------------------------------|
| 1        | <b>DEF</b> <b>A</b> | START YEAR = |                                           |
| 2        | 1976 <b>ENTER</b>   | MONTH =      | Base date 1976 year 10 month 5 day input  |
| 3        | 10 <b>ENTER</b>     | DAY =        |                                           |
| 4        | 5 <b>ENTER</b>      | END YEAR =   |                                           |
| 5        | 1982 <b>ENTER</b>   | MONTH =      | Target date 1982 year 6 month 4 day input |
| 6        | 6 <b>ENTER</b>      | DAY =        |                                           |
| 7        | 4 <b>ENTER</b>      | DAYS = 2068. |                                           |
| 8        | <b>ENTER</b>        | END YEAR =   |                                           |
| 9        | 1985 <b>ENTER</b>   | MONTH =      | Target date 1985 year 1 month 1 day input |
| 10       | 1 <b>ENTER</b>      | DAY =        |                                           |
| 11       | 1 <b>ENTER</b>      | DAYS = 3010. |                                           |
| 12       | <b>ENTER</b>        | END YEAR =   |                                           |
| 13       | <b>DEF</b> <b>Z</b> | >            |                                           |

# FLOWCHART

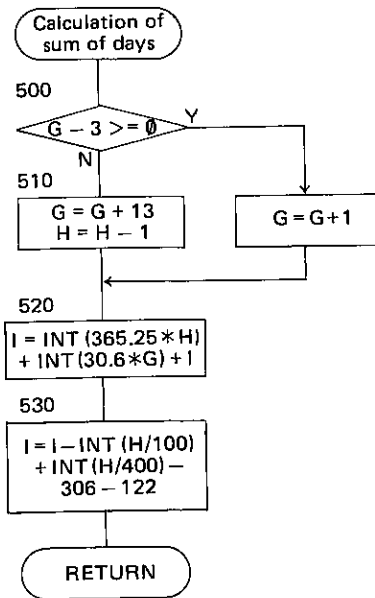
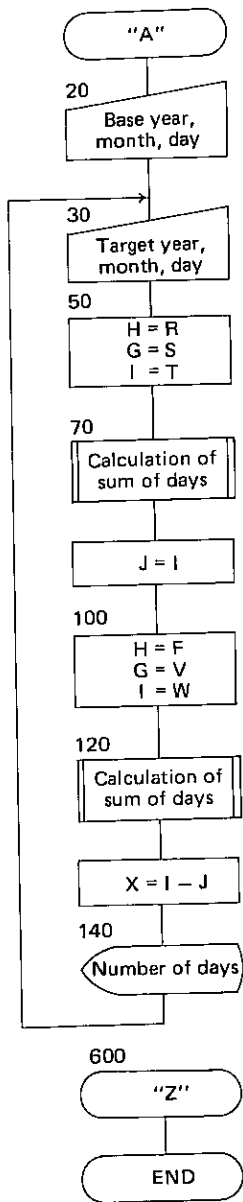

promsoft.com

# PROGRAM LIST

```

10:"A"
20:INPUT "START YEAR=";
 R;"MONTH=";S;"DAY=";
 T
30:INPUT "END YEAR=";F;
 "MONTH=";Y;"DAY=";W
50:H=R
60:G=S:I=T
70:GOSUB 500
80:J=I
100:H=F
110:G=Y:I=W
120:GOSUB 500
130:X=I-J
140:WAIT : USING : PRINT
 "DAYS=",X
150:GOTO 30
500:IF G-3>=0 LET G=G+1:
 GOTO 520
510:G=G+13:H=H-1
520:I= INT (365.25*H)+
 INT (30.6*G)+I
530:I=I- INT (H/100)+
 INT (H/400)-306-122:
 RETURN
600:"Z": END

```

270

# MEMORY CONTENTS

|   |                          |
|---|--------------------------|
| A |                          |
| B |                          |
| C |                          |
| D |                          |
| E |                          |
| F | Year (after calculation) |
| G | ✓                        |
| H | ✓                        |
| I | ✓                        |
| J | ✓                        |
| K |                          |
| L |                          |
| M |                          |
| N |                          |
| O |                          |
| P |                          |
| Q |                          |
| R | Start year               |
| S | Month of base date       |
| T | Day of base date         |
| U |                          |
| V | Month of target date     |
| W | Day of target date       |
| X | Number of days           |
| Y |                          |
| Z |                          |

## **OVERVIEW**

Quick key operation!

How fast and accurate is your typing?

If you practice with this program, it will make programming much easier for you. Improve your skill!

## **CONTENTS (such as calculation contents)**

The number of characters (4 ~ 6) is randomly chosen.

The character arrangement (A ~ Z) is done randomly.

The allotted time depends on the number of characters and the grade level.

3 is the shortest time allotment while 1 is the longest.

## **INSTRUCTIONS**

After the buzzer sounds 4 to 6 characters will be displayed. You are to type in the same characters within the allotted time.

If they are all correct, you get 10 points.

If more than half are correct, you get 5 points.

After the allotted time is over, the next problem is displayed. The allotted time depends on the grade, which has three levels (1, 2, 3).

3 is the shortest time allotment while 1 is the longest.

Point competition is done within the same grade category.

There are 10 problems, making the maximum score 100 points.

# KEY OPERATION SEQUENCE

| Step No. | Key Input           | Display           | Remarks                                                               |
|----------|---------------------|-------------------|-----------------------------------------------------------------------|
| 1        | <b>DEF</b> <b>Z</b> | GRADE (1, 2, 3)?  | Grade input                                                           |
| 2        | 1 <b>ENTER</b>      | A Z B D C         |                                                                       |
| 3        | <b>A</b>            | A Z B D C A       |                                                                       |
| 4        | <b>Z</b>            | A Z B D C A Z     |                                                                       |
|          | ⋮                   | ⋮                 |                                                                       |
|          | ⋮                   | YOUR - SCORE = 80 | After the 10 questions are answered the score is displayed            |
|          |                     | YOUR SCORE BEST   | If your score is higher than the high score the guidance is displayed |
|          |                     | >                 |                                                                       |
| 1        | <b>DEF</b> <b>A</b> | HIGH - SCORE = 80 | When you want to play in the same grade                               |
|          |                     | B W V S           |                                                                       |
| 2        | <b>B</b>            | B W V S B         |                                                                       |
|          | ⋮                   | ⋮                 |                                                                       |
|          | ⋮                   | YOUR - SCORE = 60 |                                                                       |
|          |                     | >                 |                                                                       |

# FLOWCHART

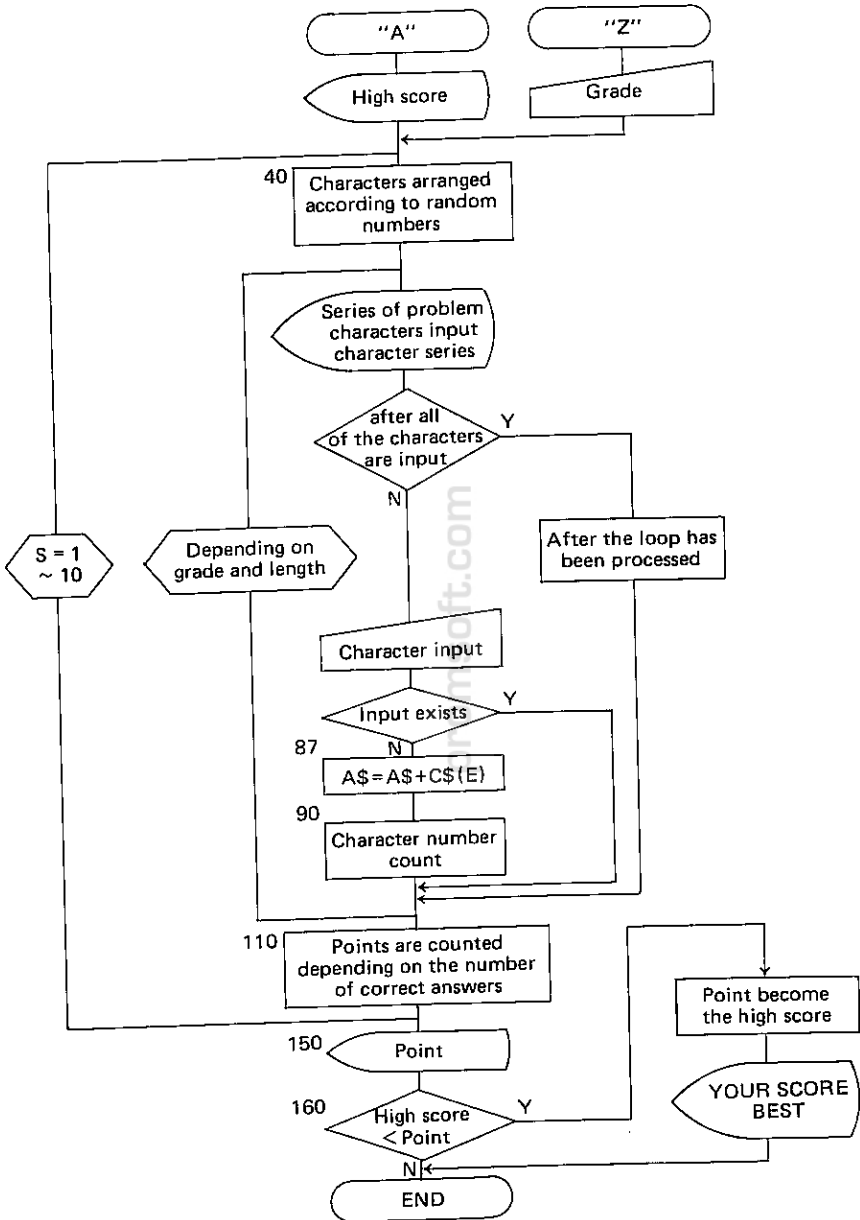

# PROGRAM LIST

```

10:"Z": CLEAR : DIM B$(
5),C$(5): RANDOM
15:INPUT "GRADE(1,2,3)?
":L: WAIT 0
17:IF (L=1)+(L=2)+(L=3)
<>1 THEN 15
18:GOTO 30
20:"A": WAIT 0:P=0:
PAUSE "HIGH-SCORE=";
X
30:FOR S=1 TO 10
40:B= RND 4+2:Y$="":R=
INT (B/2)
50:FOR C=0 TO B-1:C$(C)
=" "
60:D= RND 26:B$(C)=
CHR$(D+64):Y$=Y$+
CHR$(D+64): NEXT C
:A$=""
70:BEEP 3:E=0: WAIT 30:
USING "#####"
80:FOR W=1 TO B*10/L:
PRINT Y$:A$: IF E=B
LET W=B*20/L: GOTO 1
00
85:C$(E)= INKEY$: IF C
$(E)=" " THEN 100
87:A$=A$+C$(E)
90:E=E+1
100:NEXT W:Q=0
110:FOR W=0 TO B-1: IF B
$(W)=C$(W) LET Q=Q+1
120:NEXT W: IF Q<=R THEN
150
130:IF Q=B LET P=P+10:
GOTO 150
140:P=P+5
150:NEXT S: USING : BEEP
3: PAUSE "YOUR-SCORE
=";P

```

```

160:IF P>X LET X=P: WAIT
100: PRINT "YOUR SCO
RE BEST"
170:END
467

```

## MEMORY CONTENTS

|        |              |
|--------|--------------|
| A\$    | ✓            |
| B      | ✓            |
| C      | Loop counter |
| D      | ✓            |
| E      | ✓            |
| F      |              |
| G      |              |
| H      |              |
| I      |              |
| J      |              |
| K      |              |
| L      | Grade        |
| M      |              |
| N      |              |
| O      |              |
| P      | Score        |
| Q      | ✓            |
| R      | ✓            |
| S      | Loop counter |
| T      |              |
| U      |              |
| V      |              |
| W      | Loop counter |
| X      | High score   |
| Y\$    |              |
| Z      |              |
| B\$(5) | ✓            |
| C\$(5) | ✓            |



## OVERVIEW

This game involves landing a rocket, with only a limited amount of fuel, as softly as possible. The rocket is in free fall. The engine is used to slow down the free falling rocket. If ignition takes place too soon or too much fuel is used, then the rocket is thrust back out into space and becomes dust around the planet. If all the fuel is burned up, the rocket hits the planet and blows up. The aim is to land the rocket as softly as possible by controlling the engines while watching how much fuel is burned.

## CONTENTS

Gravity is set to be  $5 \text{ m}/(\text{unit time})^2$ .

If 5 units of fuel per a unit time are burnt, then gravity is offset.

Equations

$$H = H_0 + V_0 t + \frac{1}{2} a t^2$$

$$V = V_0 + a t$$

$$V^2 = V_0^2 + 2 a H$$

$$H_0 = 500, V_0 = -50, F_0 = 200$$

H : height  $H_0$  : initial height

V : speed  $V_0$  : initial speed

a : gravitational acceleration  $F_0$  : initial fuel

t : time F : fuel burned

$V_0$  : initial speed

The initial height, initial fuel level, and the wait time is stored in line 30 as data. By changing these values the above variables can be changed.

## INSTRUCTIONS

1. It is started by pressing **DEF** **A** . Press **0** ~ **9** keys to adjust the amount of fuel used to land the rocket.

# KEY OPERATION SEQUENCE

| Step No. | Key Input                                           | Display           | Remarks                                                                   |
|----------|-----------------------------------------------------|-------------------|---------------------------------------------------------------------------|
| 1        | DEF A                                               | ***START***       |                                                                           |
| 2        | Keys 0 ~ 9<br>designate fuel burned<br>in unit time | 500 -50 200 0     | Height, speed, fuel left and<br>fuel burnt in unit time are<br>displayed. |
|          | 9                                                   | 452 -46 191 9     |                                                                           |
|          | ⋮                                                   |                   |                                                                           |
|          | ⋮                                                   | Repeat            |                                                                           |
|          | ⋮                                                   |                   |                                                                           |
|          | (If successful)                                     | SUCCESS !!        |                                                                           |
|          |                                                     | FUEL LEFT: F = 15 |                                                                           |
|          |                                                     |                   |                                                                           |
|          | (If failed)                                         | GOOD BYE!!        |                                                                           |
|          |                                                     |                   |                                                                           |
|          |                                                     | REPLAY (Y/N)?     | Wait for input on whether<br>you wish to play again                       |
|          | Y                                                   |                   | Play again                                                                |
|          | N                                                   | >                 | End                                                                       |

# FLOWCHART

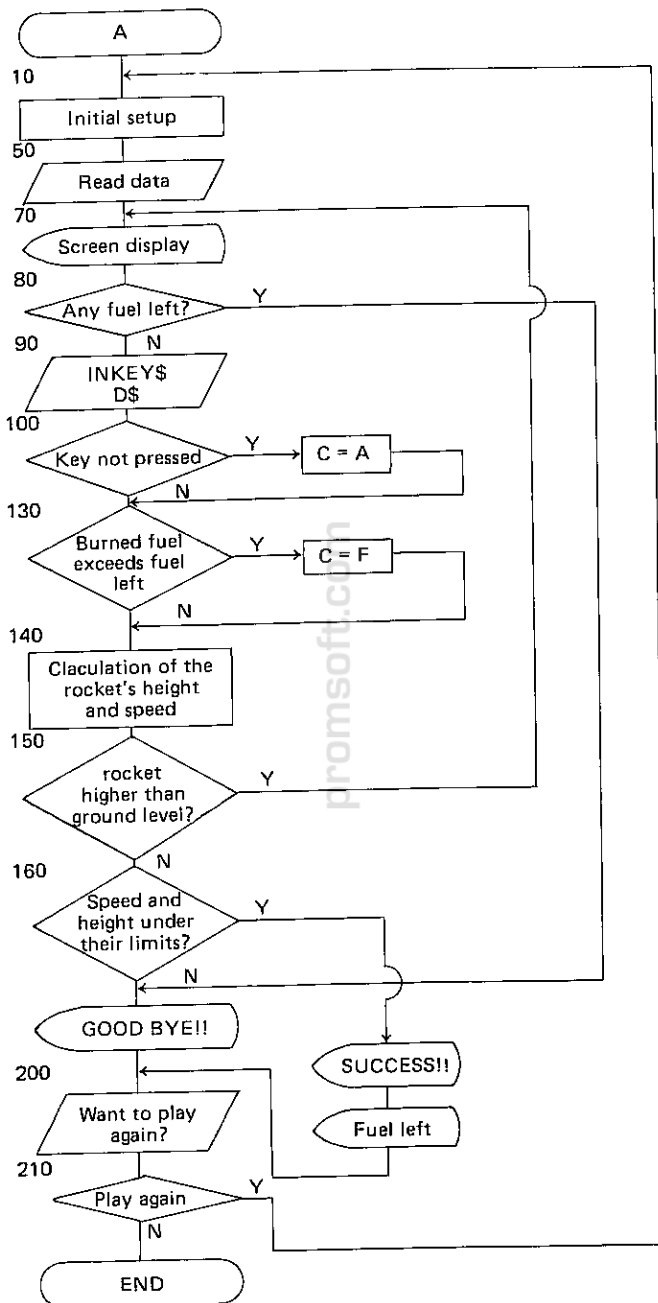

# PROGRAM LIST

```

10:"A": WAIT 50: CLEAR
 : USING :S=-50:A=0:D
 $=""
20:BEEP 3: PRINT " ***
 START ***"
30:DATA "TIME=",50,"FUE
 L=",200,"HEIGHT=",50
 0
40:RESTORE
50:READ B$,W,B$,F,B$,H
60:WAIT W
70:PRINT USING "####";H
 ;S;F;C
80:IF F<=0 GOTO 170
90:BEEP 1:D$= INKEY$
100:IF D$="" LET C=A:
 GOTO 130
110:C= VAL D$
120:A=C
130:IF C>F LET C=F
140:F=F-C:X=C-5:H=H+S+X/
 2:S=S+X
150:IF H>0 GOTO 70
160:IF (ABS H<5)+(ABS
 S<5)=2 BEEP 5: PRINT
 "SUCCESS!!": GOTO 18
 0
170:BEEP 3: PRINT "GOOD
 BYE!!": GOTO 190
180:WAIT 150: PRINT
 USING "####";"FUEL L
 EFT:F=";F
190:WAIT 50: PRINT "REPL
 AY (Y/N) ?":Z$=
 INKEY$
200:IF (Z$="Y")+(Z$="N")
 <>1 GOTO 190
210:IF Z$="Y" GOTO 10
220:END

```

413

# MEMORY CONTENTS

|     |                               |
|-----|-------------------------------|
| A   | ✓                             |
| B\$ | ✓                             |
| C   | Fuel burned                   |
| D\$ | Fuel burned                   |
| E   |                               |
| F   | Initial fuel level, fuel left |
| G   |                               |
| H   | Initial height, height        |
| I   |                               |
| J   |                               |
| K   |                               |
| L   |                               |
| M   |                               |
| N   |                               |
| O   |                               |
| P   |                               |
| Q   |                               |
| R   |                               |
| S   | Speed                         |
| T   |                               |
| U   |                               |
| V   |                               |
| W   | Wait time                     |
| X   | ✓                             |
| Y   |                               |
| Z\$ | ✓                             |

promsoft.com

# Program Title: MEMORY CHECKER

## OVERVIEW

Three line with a total of 12 characters will be displayed on the screen for approx. 5 seconds.

Your memory will be tested by how well you input the above line after it has disappeared.

## CONTENTS

The following type of line will be displayed for approx. 5 seconds. There are 2 characters and 2 numbers in each set.

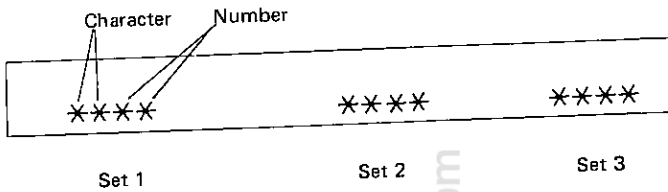

The 3 sets shown above are to be memorized and then input as answers.

The computer will then analyze your answers and place you in one of the possible 7 categories.

Each set is split into 2 parts of former 2 and latter 2 characters, giving a total of 6 points when all the answers are correct.

| Points | Evaluation Message |
|--------|--------------------|
| 0      | IDIOT              |
| 1      | BAD                |
| 2      | AVERAGE            |
| 3      | OK                 |
| 4      | GOOD !             |
| 5      | * INTELLIGENT *    |
| 6      | **GENIUS**         |

# KEY OPERATION SEQUENCE

| Step No. | Key Input                         | Display              | Remarks                                                           |
|----------|-----------------------------------|----------------------|-------------------------------------------------------------------|
| 1        | <b>DEF</b> <b>A</b>               | MEMORY CHECK         | Title                                                             |
| 2        |                                   | **XX    **XX    **XX | Display of problem line (5 sec.)<br>*... character<br>X... number |
| 3        |                                   | ANS. = _             | Waiting for the input of set 1                                    |
| 4        | (Example) <b>ENTER</b><br>AB12    | ANS. = _             | Waiting for the input of set 2                                    |
| 5        | **XX <b>ENTER</b>                 | ANS. = _             | Waiting for the input of set 3                                    |
| 6        | **XX <b>ENTER</b>                 | **XX    **XX    **XX | Display of the input.                                             |
| 7        |                                   | **XX    **XX    **XX | Display of the problem line (1.5 sec.)                            |
| 8        |                                   | **XX    **XX    **XX | Redisplay of the input                                            |
| 9        |                                   | IDIOT                | display of category                                               |
|          |                                   | BAD                  |                                                                   |
|          |                                   | AVERAGE              |                                                                   |
|          |                                   | OK                   |                                                                   |
|          |                                   | GOOD!                |                                                                   |
|          |                                   | * INTELLIGENT *      |                                                                   |
|          |                                   | **GENIUS**           |                                                                   |
| 10       |                                   | REPLAY (Y/N) ?       | Player input request                                              |
| 11       | <b>Y</b> or <b>N</b> <b>ENTER</b> |                      | If Y, go to step 2                                                |
|          |                                   | >                    | If N, END                                                         |

# FLOWCHART

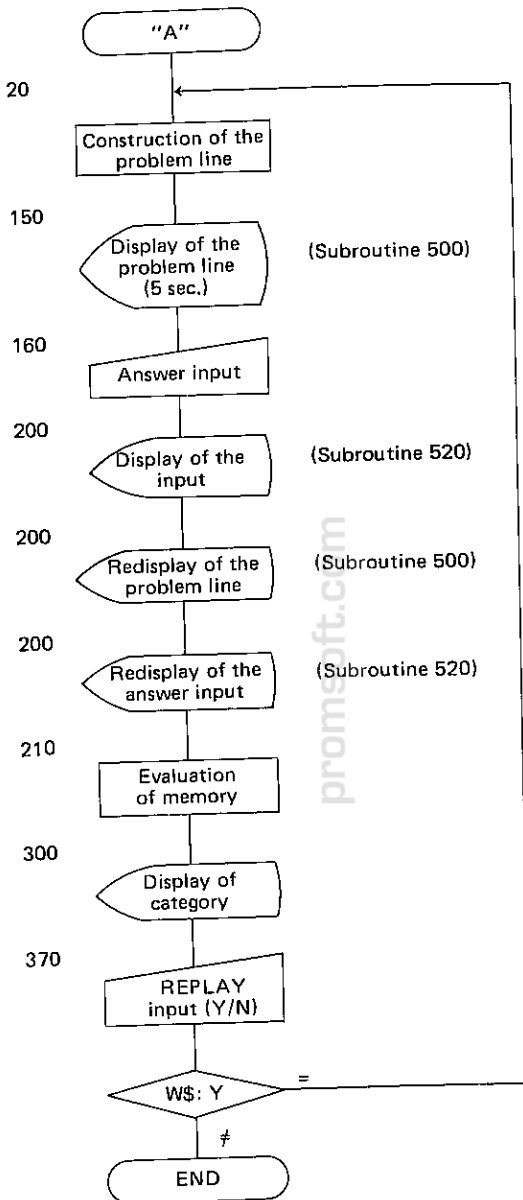

# PROGRAM LIST

```

10:"A": USING : WAIT 20
 0: PRINT "MEMORY CHE
 CK": CLEAR : RANDOM
20: DIM G$(6)*1,N$(10)*1
 ,V$(3)*2,X$(3)*4,Z$(
 3)*2,Y$(3)*4
30: FOR I=1 TO 9:N$(I)=
 STR$ I: NEXT I:N$(10
)="0"
50: FOR I=1 TO 6
60: J= RND 26:J=J+64
70: G$(I)= CHR$(J):
 NEXT I
80: FOR I=1 TO 3
90: Y$(I)=" "
100: FOR J=1 TO 2:K= RND
 9
110: Y$(I)=Y$(I)+N$(K):
 NEXT J
120: J=(I-1)*2+1
130: A$(I)=G$(J)+G$(J+1)
140: H$=Y$(I):A$(I+3)=
 RIGHT$(H$,2): NEXT
 I
150: GOSUB 500
160: FOR I=1 TO 3
170: INPUT " ANS. = ";X$(
 I):X$(I)= LEFT$(X$(
 I),4)
180: Z$(I)= LEFT$(X$(I),
 2)
190: V$(I)= RIGHT$(X$(I)
 ,2): NEXT I
200: GOSUB 520: GOSUB 500
 : GOSUB 520
210: N=0
220: FOR I=1 TO 3
230: IF A$(I)=Z$(I) LET N
 =N+1
240: IF A$(I+3)=V$(I) LET
 N=N+1
250: NEXT I
260: N=N+1
270: WAIT 150: ON N GOTO
 300,310,320,330,340,
 350,360
300: BEEP 1: PRINT " IDI
 OT": GOTO 370
310: BEEP 1: PRINT " BAD
 ": GOTO 370
320: BEEP 2: PRINT " AVE
 RAGE": GOTO 370
330: BEEP 2: PRINT " OK
 ": GOTO 370
340: BEEP 3: PRINT " GO
 OD!": GOTO 370
350: BEEP 4: PRINT "* INT
 ELLIGENT.*": GOTO 37
 0
360: BEEP 5: PRINT "**GEN
 IUS**"
370: W$="": BEEP 1: INPUT
 "REPLAY (Y/N)?":W$
380: IF W$="N" THEN 600
390: IF W$="Y" THEN 50
395: GOTO 370
400: GOTO 370
500: WAIT 300: BEEP 2:
 PRINT A$(1);A$(4);"
 ";A$(2);A$(5);" ";
 A$(3);A$(6)
510: RETURN
520: WAIT 80: BEEP 1:
 PRINT USING "#####"
 ;X$(1);X$(2);X$(3)
525: USING
530: RETURN
600: END

```

838



# MEMORY CONTENTS

|          |                                    |
|----------|------------------------------------|
| A\$      |                                    |
| B\$      |                                    |
| C\$      | 2 columns of characters            |
| D\$      |                                    |
| E\$      |                                    |
| F\$      |                                    |
| G        |                                    |
| H\$      | √                                  |
| I        | Index                              |
| J        | Random number generation           |
| K        | Random number generation           |
| L        | Random number generation           |
| M        |                                    |
| N        | Counter                            |
| O        |                                    |
| P        |                                    |
| Q        |                                    |
| R        |                                    |
| S        |                                    |
| T        |                                    |
| U        |                                    |
| V        |                                    |
| W\$      | input for REPLAY                   |
| X        |                                    |
| Y        |                                    |
| Z        |                                    |
| G\$(6)*1 | Characters (1 ~ 6)                 |
| NS(10)*1 | Number table (1 ~ 10)              |
| V\$(3)*2 | 2 columns after answering (1 ~ 3)  |
| X\$(3)*4 | Work (1 ~ 3)                       |
| Y\$(3)*4 | Work (1 ~ 3)                       |
| Z\$(3)*2 | 2 columns before answering (1 ~ 3) |

## OVERVIEW

This is a game involving a man chasing after a bug.

## CONTENTS

The bug moves according to random numbers.

The man chases the bug and kills it.

The man moves by using the **8** **4** **6** **2** keys. (INKEY\$ is used)

Each time the man moves one space, so does the bug. (Sometimes the bug will stay in the same place)

Initially the man is in position (0, 0).

The bug is placed at a position that was chosen randomly.

Hints are displayed as distance.

The distance is displayed by the  $ABS(X-a)+ABS(Y-b)$  equation.

The initial energy level is 100.

This decreases by 1 with time.

Each time that a bug is killed, the energy increases by 5, 10, or 15. (The amount is chosen randomly.)

The score is determined by how many bugs were killed when the energy level reaches 0.

(The position of the bug may "warp" when cornered.)

The program can be started by either pressing RUN **ENTER** or **DEF** **A**.

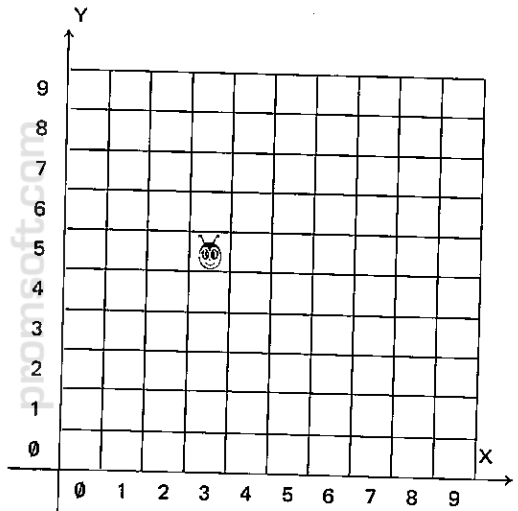

Position of the man (X, Y)

Position of the bug (a, b)

### Concerning the display

(Small characters are actual values)

|        |       |       |
|--------|-------|-------|
| (x, y) | D = ℓ | E = e |
|--------|-------|-------|

Present position

Hint  
(distance)

Remaining energy

- Each time the man moves the display changes

Bug is caught

HIT! HIT!

BANG! BANG!

SCORE t

ENERGY e

Concerning the BEEP sound

- ★ Hint: When the distance is 1 the BEEP goes off 3 times

|   |   |   |
|---|---|---|
| 2 | " | 2 |
| 3 | " | 1 |

- ★ If the distance is greater than 3 no BEEP is given.
- ★ When the bug is caught, the BEEP goes off 5 times.

### KEY OPERATION SEQUENCE

| Step No. | Key Input | Display              | Remarks |
|----------|-----------|----------------------|---------|
| 1        | DEF A     | (0, 0) D = 5 E = 100 |         |
| 2        | 8         | (0, 1) D = 4 E = 99  |         |
| 3        | 6         | (1, 1) D = 2 E = 98  | 2 BEEPs |
| 4        | 8         | HIT! HIT!            | 5 BEEPs |
| 5        |           | BANG! BANG!          |         |
| 6        |           | SCORE 1              |         |
| 7        |           | ENERGY 108           |         |

# FLOWCHART

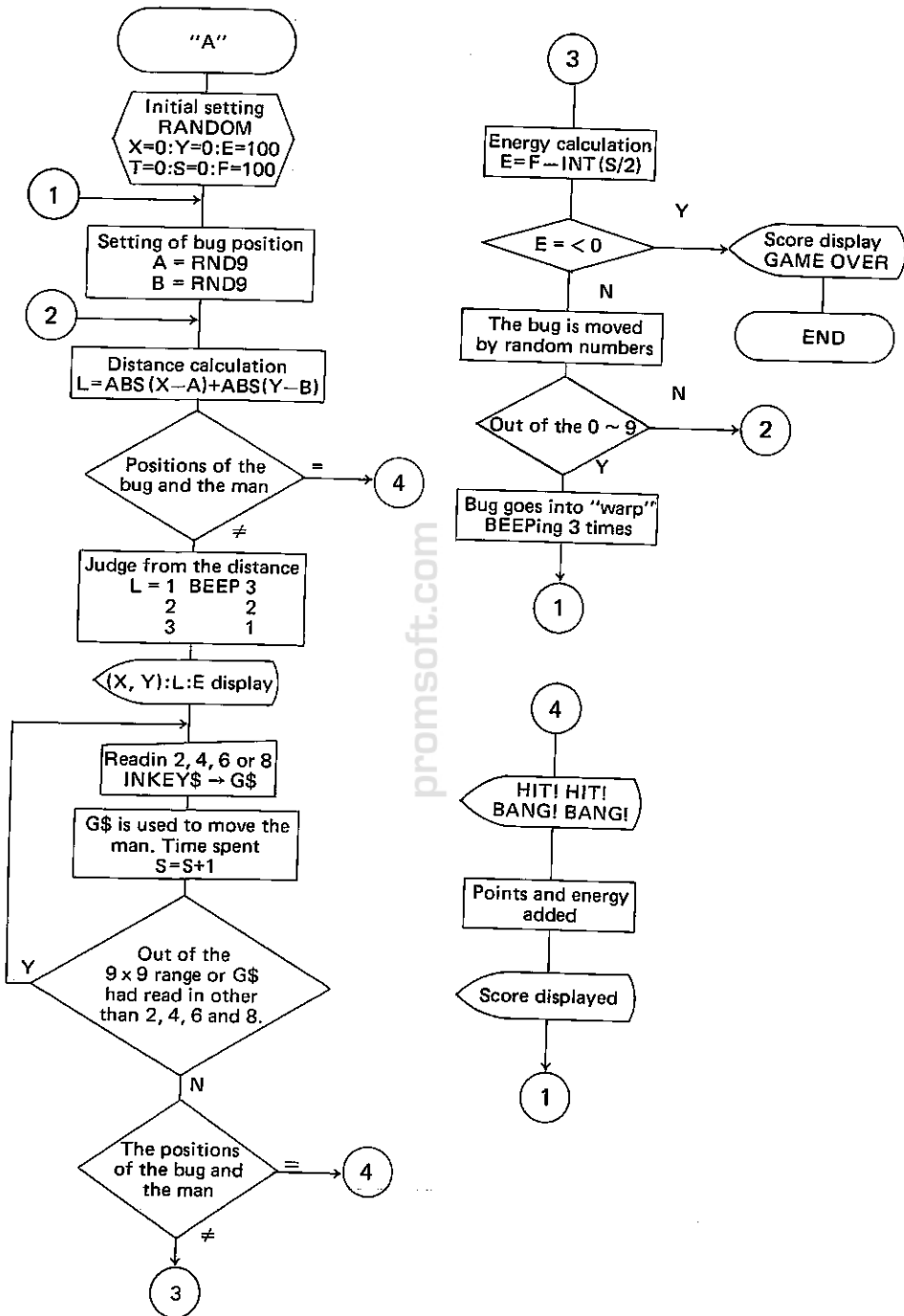

# PROGRAM LIST

```

10: "A": RANDOM : WAIT 2
 50: PRINT "**BUGHUNT
 GAME**": BEEP 3
20: X=0:Y=0:E=100:F=100:
 T=0:S=0
30: A= RND 9: B= RND 9
40: L= ABS (X-A)+ ABS (Y
 -B)
50: IF X=A AND Y=B GOTO
 400
100: IF L=1 BEEP 3
110: IF L=2 BEEP 2
120: IF L=3 BEEP 1
130: WAIT 50: PRINT "(";
 STR$ (X); ", "; STR$ (
 Y); ") D= "; STR$ (L);
 " E= "; STR$ (E)
150: S=S+1: E=F- INT (S/2)
153: IF E<=0 THEN 500
155: G$= INKEY$: IF G$="
 " GOTO 130
157: BEEP 1
160: IF G$="2" LET Y=Y-1:
 GOTO 210
170: IF G$="4" LET X=X-1:
 GOTO 210
180: IF G$="6" LET X=X+1:
 GOTO 210
190: IF G$="8" LET Y=Y+1:
 GOTO 210
200: GOTO 150
210: IF X<0 LET X=0: GOTO
 150
220: IF Y<0 LET Y=0: GOTO
 150
230: IF X>9 LET X=9: GOTO
 150
240: IF Y>9 LET Y=9: GOTO
 150
250: IF X=A AND Y=B GOTO
 400
260: E=F- INT (S/2)
270: IF E<=0 GOTO 500
280: R= RND 5
290: IF R=1 LET B=B-1:
 GOTO 340
300: IF R=2 LET A=A-1:
 GOTO 340
310: IF R=3 LET A=A+1:
 GOTO 340
320: IF R=4 LET B=B+1:
 GOTO 340
340: IF A<0 OR A>9 GOTO 3
 70
350: IF B<0 OR B>9 GOTO 3
 70
360: GOTO 40
370: BEEP 4: PAUSE "*** W
 ARP ***": GOTO 30
400: PAUSE "HIT! HIT!"
410: BEEP 5
420: PAUSE "BANG! BANG!"
430: T=T+1: C= RND 3*5: F=F
 +C
435: E=F- INT (S/2)
440: WAIT 100: PRINT "SCO
 RE "; T: PRINT "ENERG
 Y "; E
450: GOTO 30
500: WAIT 100: PRINT "SCO
 RE "; STR$ (T): WAIT
 : PRINT " *GAME OVER
 !!*"
510: END
729

```

## MEMORY CONTENTS

|     |                              |
|-----|------------------------------|
| A   | Position of bug X coordinate |
| B   | Position of bug Y coordinate |
| C   | Amount of energy added       |
| D   |                              |
| E   | Remaining energy             |
| F   | Energy level                 |
| G\$ | Key read in                  |
| H   |                              |
| I   |                              |
| J   |                              |
| K   |                              |
| L   | Distance between bug and man |
| M   |                              |
| N   |                              |
| O   |                              |
| P   |                              |
| Q   |                              |
| R   | Size of bug movement         |
| S   | Time spent                   |
| T   | Score                        |
| U   |                              |
| V   |                              |
| W   |                              |
| X   | Man position X coordinate    |
| Y   | Man position Y coordinate    |
| Z   |                              |

## OVERVIEW

Quickly put in order A, B, C . . . . .

This is a game that arranges randomly placed characters (A – J) in alphabetical order. When the letters are arranged in the right order, a score is displayed. The trick is to attack from the best place.

The sooner the characters are arranged, the better.

It is fun to race with 2 or 3 of your friends.

## INSTRUCTIONS

1. After the program is initiated, by pressing **DEF** **A** , "DOUBLE ROTATION" is displayed. A random sequence of characters (A – J) is then displayed.
2. The space in between the characters is taken as the break points (1 – 9) where the numbers are placed. Inputting a break number causes the characters on each side of the breakpoint to be rotated by moving them to the far ends of the row.
3. After the characters have been placed in order, the number of moves required is displayed as the score. The lower the score the better.

## EXAMPLE

In (1) 4 is input, "F" and "I" move to each side changing the configuration to (2). If 1 is now input, the "E" moves to the far right but "F" stays in its place because it is already in the far left position, becoming configuration (3).

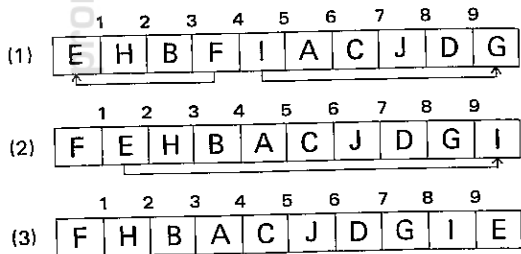

## KEY OPERATION SEQUENCE

| Step No. | Key Input | Display                     | Remarks                                                             |
|----------|-----------|-----------------------------|---------------------------------------------------------------------|
| 1        | DEF A     | DOUBLE ROTATION             |                                                                     |
|          |           | A ~ J                       | Random requence display                                             |
| 2        | 1 ~ 9     | ⋮                           | Numbers between 1 and 9 are selected and input                      |
|          |           | Repeated input              |                                                                     |
|          |           | ⋮                           |                                                                     |
|          |           | ABCDEFGHIJ                  |                                                                     |
|          |           | GAME END                    |                                                                     |
|          |           | YOUR SCORE 35               |                                                                     |
|          |           | >                           |                                                                     |
|          |           |                             | Does player want to play using the same beginning random alphabets? |
| 1        | DEF B     | A ~ J                       |                                                                     |
|          |           | Same as DEF A in succession |                                                                     |

If the 2 lines are changed as below, then the game is easier to play and  key can be used.

180: C = VAL D\$: IF D\$ = "0" GOTO 210

240: IF C = < 1 GOTO 260



# FLOWCHART

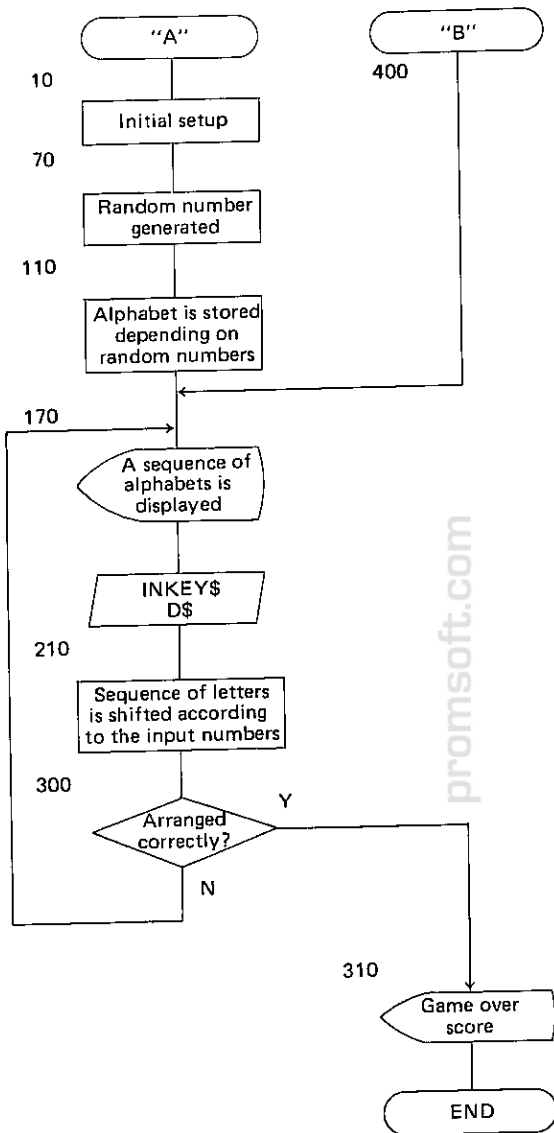

promsoft.com

## PROGRAM LIST

```

10:"A": CLEAR : WAIT 50
 : RANDOM : DIM B$(4)
20:PAUSE "DOUBLE ROTATI
 ON"
30:B$(0)="ABCDEFGH IJ"
40:B$(1)=" "
50:A=0
60:FOR I=1 TO 10
70:R= RND 10
80:S=2^(R-1)
85:B=S AND A
90:IF B<>0 GOTO 70
100:A=A OR S
110:B$(1)=B$(1)+ MID$(B
 $(0),R,1): NEXT I
120:B$(2)=B$(1)
130:N=0
150:BEEP 1
170:D$="": PRINT B$(2):D
 $= INKEY$
180:C= VAL D$
190:IF C=0 GOTO 170
210:B$(3)= LEFT$(B$(2),
 C)
220:B$(4)= RIGHT$(B$(2)
 ,10-C)
240:IF C=1 GOTO 260
250:B$(3)= RIGHT$(B$(3)
 ,1)+ LEFT$(B$(3),C-
 1)
260:IF C=9 GOTO 280
270:B$(4)= RIGHT$(B$(4)
 ,9-C)+ LEFT$(B$(4),
 1)
280:B$(2)=B$(3)+B$(4)
290:N=N+1
300:IF B$(2)<>B$(0) GOTO
 150
310:BEEP 5: PAUSE "GAME
 END"
320:WAIT 200: PRINT
 USING "####": "YOUR S
 CORE":N
330:END
400:"B": WAIT 50: GOTO 1
 20

```

471

## MEMORY CONTENTS

|        |                    |
|--------|--------------------|
| A      | ✓                  |
| B      | ✓                  |
| C      | ✓                  |
| D\$    | Input key          |
| E      |                    |
| F      |                    |
| G      |                    |
| H      |                    |
| I      | ✓                  |
| J      |                    |
| K      |                    |
| L      |                    |
| M      |                    |
| N      | Score              |
| O      |                    |
| P      |                    |
| Q      |                    |
| R      | Random numbers     |
| S      | ✓                  |
| T      |                    |
| U      |                    |
| V      |                    |
| W      |                    |
| X      |                    |
| Y      |                    |
| Z      |                    |
| B\$(4) | Alphabet sequences |

## Modification Summary of the CE-125 Program Examples

**Program  
Title**

### MATRIX PRODUCT

- KEY OPERATION SEQUENCE

REVISION POSITION = \_

⇒

REV. POSITION = \_

ALL DATA PRINT? (Y/N) \_

⇒

ALL PRINT (Y/N) \_

- Change 2 step of the program list as follows:

```
160:"B":B$(0)="": INPUT
 "REV. POSITION=";B$(
0):Z= LEN B$(0):
 GOTO 170
```

```
250:INPUT "ALL PRINT(Y/N
)" ;G$
```

**Program  
Title**

### NUMERICAL INTEGRATION USING SIMPSON'S RULE

- KEY OPERATION SEQUENCE

F(X): INPUT = 1/CAL. = 2 ? \_

⇒

INP. = 1/CAL. = 2 ? \_

ALL DATA PRINT? (Y/N) \_

⇒

ALL PRINT (Y/N) \_

- Change 2 steps of the program list as follows:

```
10:"A": CLEAR : WAIT 0:
 INPUT "INP.=1/CAL.=2
 ?";I0: GOTO 16
```

```
140:INPUT "ALL PRINT(Y/N
)" ;I$
```

Program  
Title

## CORRELATION COEFFICIENT AND LINEAR REGRESSION

### • KEY OPERATION SEQUENCE

REVISION POSITION = \_

⇒

REV. POSITION = \_

ALL DATA PRINT? (Y/N)\_

⇒

ALL PRINT (Y/N)\_

### • Change 2 step of the program list as follows:

```
500: "B": B$(0) = "": INPUT
 "REV. POSITION="; B$(
 0)
```

```
560: 0$ = "": INPUT "ALL PR
 INT(Y/N)"; I0$
```

Program  
Title

## HISTOGRAM

### • INSTRUCTIONS

"OVER-DELETED CHECK" ⇒ "OVER-DELETED"

### • Change 3 steps of the program list as follows:

```
20: PRINT "RANGE A=<DATA
 =<B": INPUT "A="; A,
 B="; B
```

```
250: IF D(N)-1<0 BEEP 2:
 WAIT : PRINT "OVER-D
 ELETED !!"
```

```
30: INPUT "SCALE UNIT SI
 ZE="; D
```

Program  
Title

## CROSS-FOOTING

### • KEY OPERATION SEQUENCE

REVISION POSITION = \_

⇒

REV. POSITION = \_

DATA IN = 1/OUT = 2? \_

⇒

DATA IN = 1/OUT = 2\_

### • Change 2 steps of the program list as follows:

```
130: INPUT "REV. POSITION
 ="; C$: Z = LEN C$: X$ =
 RIGHT$(C$, Z-2): Y =
 VAL X$: GOTO 145
```

```
530: INPUT "DATA IN=1/OUT
 =2"; K: IF (K=1)+(K=2
)=1 GOTO 550
```

Program  
Title

## SORTING

### ● KEY OPERATION SEQUENCE

CHARACTER = 1/NUMBER = 2? -

⇒

CHAR. = 1/NUM. = 2? -

INCREASE = 1/DECREASE = 2? -

⇒

INC. = 1/DEC. = 2? -

### ● Change 2 steps of the program list as follows:

```
10: "A": CLEAR : INPUT "
CHAR.=1/NUM.=2?" ; M
```

```
30: INPUT "INC.=1/DEC.=2
?" ; I O
```

Program  
Title

## THE LOAN LIMIT, CALCULATION OF THE NUMBER OF INSTALLMENTS

### ● KEY OPERATION SEQUENCE

NO. OF INSTALLMENT = \_

⇒

NO. OF INST. = \_

INSTALLMENT AMOUNT = \_

⇒

INST. AMT. = \_

### ● Change 3 steps of the program list as follows:

```
20: INPUT "NO. OF INST. =
" ; A
```

```
400: INPUT "INST. AMT. = "
B
```

```
210: INPUT "LOAN SIZE LIM
IT = " ; D
```

Program  
Title

## BIORHYTHM (SEMI-GRAPHIC)

### ● KEY OPERATION SEQUENCE

DATE OF BIRTH: YEAR = \_

⇒

BIRTH: YEAR = \_

### ● Change one step of the program list as follows:

```
30: INPUT "BIRTH: YEAR = "
; U $, "MONTH = " ; V, "DAY = "
; W
```

promsoft.com

www.promsoft.com

# INDEX

|                           |     |                      |        |
|---------------------------|-----|----------------------|--------|
| &                         |     |                      |        |
| *                         |     |                      |        |
| +                         |     |                      |        |
| -                         |     |                      |        |
| /                         |     |                      |        |
| ^                         |     |                      |        |
| √                         |     |                      |        |
| <                         |     |                      |        |
| ▲                         |     |                      |        |
| <=                        |     |                      |        |
| <>                        |     |                      |        |
| =                         |     |                      |        |
| >                         |     |                      |        |
| ▼                         |     |                      |        |
| >=                        |     |                      |        |
| π                         |     |                      |        |
| ↑                         |     |                      |        |
| ↓                         |     |                      |        |
| ABS                       |     |                      |        |
| AC adaptor, <b>CE-125</b> |     |                      |        |
| ACS                       |     |                      |        |
| ALL RESET                 |     |                      |        |
| AND                       |     |                      |        |
| AREAD                     |     |                      |        |
| ASC                       | 133 |                      |        |
| ASCII                     | 140 |                      |        |
| ASN                       | 128 |                      |        |
| ATN                       | 129 |                      |        |
| Arrays                    | 33  |                      |        |
| Auto off (Auto Power Off) | 17  |                      |        |
| BEEP                      | 84  |                      |        |
| Batteries, <b>PC-1245</b> | 14  |                      |        |
| Busy                      | 11  |                      |        |
| CA key                    | 10  |                      |        |
| CE-125                    | 54  |                      |        |
|                           | 32  | CHAIN                | 85     |
|                           | 36  | CHR\$                | 133    |
|                           | 36  | CLEAR                | 87     |
|                           | 36  | CLOAD                | 70     |
|                           | 36  | CLOAD?               | 71     |
|                           | 36  | CLear key            | 10     |
|                           | 132 | CONT                 | 72     |
|                           | 37  | COS                  | 129    |
|                           | 20  | CSAVE                | 73     |
|                           | 37  | Cursor               | 11     |
|                           | 37  | Cassette             | 61     |
|                           | 37  | Commands             | 43, 67 |
|                           | 37  | Compatability        | 150    |
|                           | 20  | Constants            | 30, 32 |
|                           | 37  | DATA                 | 89     |
|                           | 127 | DEF key              | 52     |
|                           | 136 | DEG                  | 129    |
|                           | 136 | DEGREE               | 88     |
|                           | 128 | DELete key           | 23     |
|                           | 56  | DIM                  | 90     |
|                           | 128 | DMS                  | 129    |
|                           | 12  | Debugging            | 136    |
|                           | 38  | Display              | 11     |
|                           | 83  | END                  | 92     |
|                           | 133 | ENTER key            | 8, 18  |
|                           | 140 | EXP                  | 130    |
|                           | 128 | Editing calculations | 20     |
|                           | 129 | Editing programs     | 45     |
|                           | 33  | Error Messages       | 138    |
|                           | 17  | Exponentiation       | 130    |
|                           | 84  | Expressions          | 35     |
|                           | 14  | FF (Fast forward)    | 55     |
|                           | 11  | FOR ... TO ... STEP  | 93     |
|                           | 10  | Fast forward         | 55     |
|                           | 54  | Formatting output    | 142    |
|                           |     | Functions            | 40, 69 |

## Index

|                     |        |                        |        |
|---------------------|--------|------------------------|--------|
| GOSUB               | 95     | P ↔ NP                 | 60     |
| GOTO                | 74, 96 | PASS                   | 81     |
| GRAD                | 97     | PAUSE                  | 109    |
| Hexadecimal         | 32     | PI                     | 127    |
| IF ... THEN         | 98     | PRINT                  | 111    |
| INKEY\$             | 127    | PRINT #                | 113    |
| INPUT               | 99     | PRoGram mode           | 43     |
| INPUT #             | 101    | Paper feed             | 59     |
| INSert key          | 46     | Parentheses            | 40     |
| INT                 | 130    | Power                  | 56     |
| LEFT\$              | 133    | Preallocated variables | 34     |
| LEN                 | 133    | Printer                | 60     |
| LET                 | 103    | Priority               | 147    |
| LIST                | 75     | Program                | 42     |
| LLIST               | 76     | Pseudovariables        | 127    |
| LN                  | 130    | RADIAN                 | 115    |
| LOG                 | 130    | RANDOM                 | 116    |
| LPRINT              | 104    | READ                   | 117    |
| Labelled programs   | 52     | REM                    | 118    |
| Limits of numbers   | 31     | RESET                  | 12     |
| Line numbers        | 42     | RESTORE                | 119    |
| Logical expressions | 38     | RETURN                 | 120    |
| Loops               | 48     | RIGHT\$                | 134    |
| MEM                 | 127    | RND                    | 131    |
| MERGE               | 77     | RUN                    | 82     |
| MID\$               | 134    | RUN mode               | 43     |
| Maintenance         | 137    | Range of numbers       | 31     |
| Masks               | 142    | Relational expressions | 37     |
| Memory Protection   | 50     | Remote On/Off          | 55     |
| NEW                 | 80     | SGN                    | 131    |
| NEXT                | 106    | SHIFT key              | 18, 19 |
| NOT                 | 38     | SIN                    | 131    |
| Numeric expressions | 36     | SQR                    | 132    |
| Numeric variables   | 33     | STOP                   | 121    |
| ON (Start up)       | 17     | STR\$                  | 134    |
| ON ... GOSUB        | 107    | Scientific notation    | 30     |
| ON ... GOTO         | 108    | Square root            | 132    |
| OR                  | 38     | Statements             | 42     |
| Operator precedence | 40     | String expressions     | 36     |
| Operator priority   | 147    | String variables       | 33     |
| Operators           | 36     | Subroutines            | 95     |





|                |     |                 |        |
|----------------|-----|-----------------|--------|
| TAN            | 132 | Troubleshooting | 135    |
| TROFF          | 122 | USING           | 124    |
| TRON           | 123 | VAL             | 134    |
| Tape, external | 63  | Variables       | 33     |
| Tape           | 61  | Verbs           | 42, 68 |
| Tape counter   | 55  | WAIT            | 126    |
| Template       | 53  |                 |        |



promsoft.com

**SHARP CORPORATION**  
**OSAKA, JAPAN**